



Constant current LEDs are to be wired in **SERIES** and require a **MINIMUM** and maximum number of fixtures connected to a driver as indicated on the following page.

POWERING or TESTING less than the MINIMUM number of fixtures per driver OR connecting fixtures with the driver live OR wiring them in parallel will **IMMEDIATELY and PERMANENTLY DESTROY the LEDs.**

Carefully read instructions prior to installation and testing.

Constant Current drivers

Wiring Key Points

1. This product shall be installed by a qualified electrician.
2. Make sure the main power supply to the driver is turned off when wiring either the LEDs or driver.
3. LEDs shall be wired in series as shown in wiring diagram. CAUTION: parallel wiring will damage LEDs.
4. Wire shall be 18 awg stranded minimum. Large gauge wire shall be used to limit voltage drop in order to maintain the proper operating voltage. Take every precaution to avoid interference from other electrical circuits and equipment.
5. Dimming circuits are more sensitive to voltage drop and electrical interference from other electrical sources.
6. Isolating LED wiring by dedicated circuit for each control zone is recommended.
7. Contractor shall verify the fixture quantities connected to the driver are compatible with the driver's specifications prior to energizing the circuit.
8. All Class II power cable remote wiring and driver enclosures by others.

LED's can be permanently damaged if these points are not followed

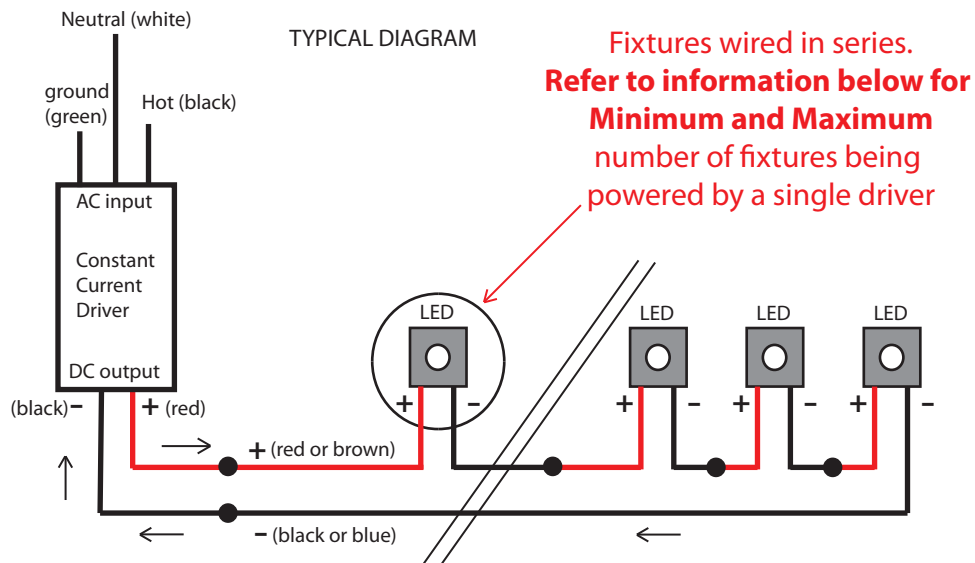

Driver options:

Driver	AC Input	Dimming	Minimum number of fixtures	Maximum number of fixtures

inter•lux

Project:	Type:	Date:
Manufacturer:	Fixture:	Page:

Dry Location Enclosure

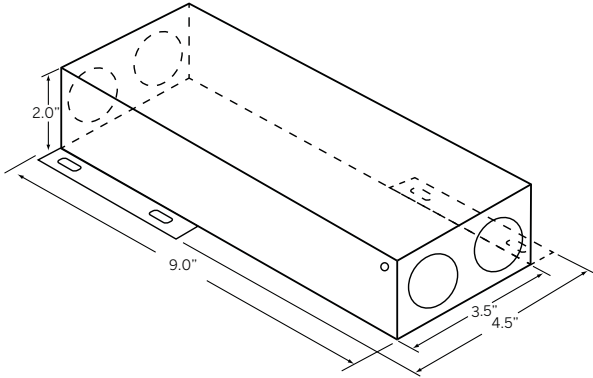

Hi-lume® 1% EcoSystem™/3-Wire L3D Driver Overview

Hi-lume® 1% EcoSystem™/3-Wire Driver is a high-performance LED driver that provides smooth, continuous 1% dimming for virtually any LED fixture, whether it requires constant-current or constant-voltage. It is the most versatile LED driver offered today due to its compatibility with a wide variety of LED arrays, multiple form factors, and numerous control options.

Features

- Continuous, flicker-free dimming from 100% to 1%.
- Compatible with Energi Savr Node™ unit with EcoSystem®, GRAFIK Eye® QS control unit, PowPak® dimming module with EcoSystem®, and Quantum® systems, allowing for integration into a planned or existing EcoSystem® lighting control solution. Please see **Compatible Controls** chart or contact Lutron for details regarding compatible controls.
- Standard 3-wire, line-voltage phase-control technology for consistent dimming performance and compatibility with all Lutron® 3-wire fluorescent controls.
- QwikFig™ compatible. For more information please refer to Lutron® P/N 367-2533 (K and M case only).
- Line voltage miswire protection on EcoSystem® control inputs.
- 100% performance tested at factory.
- A rated lifetime of 50,000 hours @:
 - $t_c = 149^\circ\text{F}$ (65°C) for 40 W drivers
 - $t_c = 158^\circ\text{F}$ (70°C) for 50 W drivers
- UL® recognized and listed options for United States and Canada.
- Type TL Rated.
- FCC Part 15 compliant for commercial applications at 120 V~ or 277 V~.
- Pulse Width Modulation (PWM) or Constant-Current Reduction (CCR) dimming methods available. See Application Note #360 for details.
- RoHS Compliant.
- For more information please go to: www.lutron.com/hilume1led



The Hi-lume® 1% EcoSystem™/3-Wire family of drivers includes models which operate at a maximum power of 40 W or less as well as models which can operate up to 50 W.

- 40 W or less models – output ranges A-M and X-Z
- 50 W models – output ranges N and W (K-case only)

For a description of the output ranges please see following pages.

LUTRON® SPECIFICATION SUBMITTAL

Page

Job Name:

Model Numbers:

Job Number:

Specifications

Regulatory Approvals

- Meets ANSI C62.41 category A surge protection standards up to and including 4 kV.
- FCC Part 15 compliant for commercial applications at 120 V \sim or 277 V \sim .
- Manufacturing facilities employ ESD reduction practices that comply with the requirements of ANSI/ESD S20.20.
- Lutron® Quality Systems registered to ISO 9001.2008.
- UL® 8750 recognized.
- UL® recognized models are also UL® classified to 1598C for field replacement capability
- UL® 8750 listed form factor available.
- Class 2 output available.
- Type TL Rated.

UL® 8750 Listed Option

- cULus® for United States and Canada available for certain operating regions.
- Pre-wired and installation ready.
- See **KL Enclosure** page for more specific details regarding UL® listed option.

Environmental

- Sound Rating: Inaudible in 27 dB ambient.
- Relative Humidity: Maximum 90% non-condensing.
- Minimum operating ambient temperature $t_a = 32\text{ }^\circ\text{F}$ ($0\text{ }^\circ\text{C}$).

Performance

- Dimming Range: 100% to 1%.
- Operating Voltage: 120–277 V \sim at 50/60 Hz.
- Lifetime: 50,000 hours @:
 - $t_c = 149\text{ }^\circ\text{F}$ ($65\text{ }^\circ\text{C}$)¹ for 40 W drivers.
 - $t_c = 158\text{ }^\circ\text{F}$ ($70\text{ }^\circ\text{C}$)¹ for 50 W drivers.
 - For rated warranty, t_c not to exceed the maximum rated temperatures listed here.¹
- Patented thermal foldback protection.
- LEDs turn on to any dimmed level without going to full brightness.
- Non-volatile memory restores all driver settings after power failure.
- Power Factor: >0.90 for loads greater than 25 W
- Standby Power Consumption: < 1.0 W
- Total Harmonic Distortion (THD): <20% for loads greater than 25 W.
- Inrush Current: < 2 A.
- Inrush Current Limiting Circuitry: eliminates circuit breaker tripping, switch arcing and relay failure.
- Open circuit protected.
- Short circuit protected.
- Turn-on time: ≤ 1.5 seconds.²
- PWM Dimming Frequency: 550 Hz.

Driver Wiring & Mounting

- Driver is grounded by a mounting screw to the grounded fixture (or by terminal connection on the K-case).
- Terminal blocks on the driver accept one solid wire per terminal from 18 AWG to 16 AWG (0.75 mm^2 to 1.5 mm^2).
- Fixture must be grounded in accordance with local and national electrical codes.
- For maximum driver to LED light engine wire lengths see **Driver Leads** section at end of document.

¹ Installer is responsible for ensuring that the driver case temperature does not exceed the maximum rated temperature.

² Models available with turn-on time ≤ 1 second.

Job Name: Job Number:	Model Numbers:
--------------------------------------	----------------

How to Build a Model Number: Hi-lume® 1% EcoSystem™/3-Wire

L3DA U1U

Maximum Power:
 4 = 40 W maximum
 5 = 50 W maximum
 (K-case only)

Case Size:
 K = Compact
 M = Stick

Case Style:
 S = Studded
 (K case only)
 N = Non-Studded
 L = UL® Listed
 (K case only)

Example: L3DA4U1UKS-HC070
 For further assistance selecting your model number, contact our LED Center of Excellence at 1.877.346.5338 or LEDs@lutron.com

Current Level (for Constant-Current):
 020 = 0.20 A; 021 = 0.21 A . . . 070 = 0.70 A . . . 210 = 2.10 A

Voltage Level (for Constant-Voltage):
 100 = 10.0 V; 105 = 10.5 V . . . 600 = 60.0 V

Driver Output:
 C = Constant-current driver
 with pulse width modulation (PWM) dimming
 A = Constant-current driver
 with constant-current reduction (CCR) dimming
 V = Constant-voltage driver
 with pulse width modulation (PWM) dimming

LED Load Output Range (see the following pages for more detail):

40 W Drivers		50 W Drivers	
<u>Class 2 Constant-Voltage</u>	<u>Class 2 Constant-Current</u>	<u>Class 2 Constant-Current</u>	
A = 10.0 V–12.0 V*	E = 0.20 A–0.50 A 30 V–54 V	N = 0.71 A–1.05 A 35 V–54 V**	
B = 12.5 V–20.0 V**	F = 0.51 A–1.00 A 30 V–54 V**		
C = 20.5 V–24.0 V**	G = 0.20 A–0.70 A 8 V–20 V	<u>Isolated Non-Class 2</u>	
D = 24.5 V–38.0 V**	H = 0.20 A–0.70 A 15 V–38 V	<u>Constant-Current</u>	
	I = 0.71 A–1.05 A 8 V–20 V	W = 0.71 A–1.05 A 35 V–60 V**	
<u>Isolated Non-Class 2</u>	J = 0.71 A–1.05 A 15 V–38 V		
<u>Constant-Voltage</u>	K = 1.06 A–1.50 A 8 V–20 V		
X = 38.5 V–60.0 V**	L = 1.06 A–1.50 A 15 V–38 V**		
	M = 1.51 A–2.10 A 8 V–19.9 V**		
	<u>Isolated Non-Class 2</u>		
	<u>Constant-Current</u>		
	Y = 0.20 A–0.50 A 30 V–60 V		
	Z = 0.51 A–1.00 A 30 V–60 V**		

* 3.33 A maximum.
 ** Output parameter is power-limited for these output ranges. Consult detailed specifications on the following pages for each range.

LUTRON® SPECIFICATION SUBMITTAL Page

Job Name:	Model Numbers:
Job Number:	

“E” Output Range, Current Driver Models

Driver Type	Output Dimming Method	Output Voltage	Output Current	Output Power	Standards Recognition	UL® Listed Option (KL case)
Constant-Current Driver (Class 2)	Constant-Current Reduction (CCR)	30–54 V \equiv	0.20–0.50 A	6–27 W	 Type TL 83 °/66 °C - K-case Type TL 90 °/72 °C - M-case	Yes

When using QwikFig™ technology, these models can be built from the following bulk units:

K-case - L3DA4U1UKx-3ABLK*; M-case - L3DA4U1UMN-3ABLK

* x = studded (S) or non-studded (N)

Current Driver Operation Range:

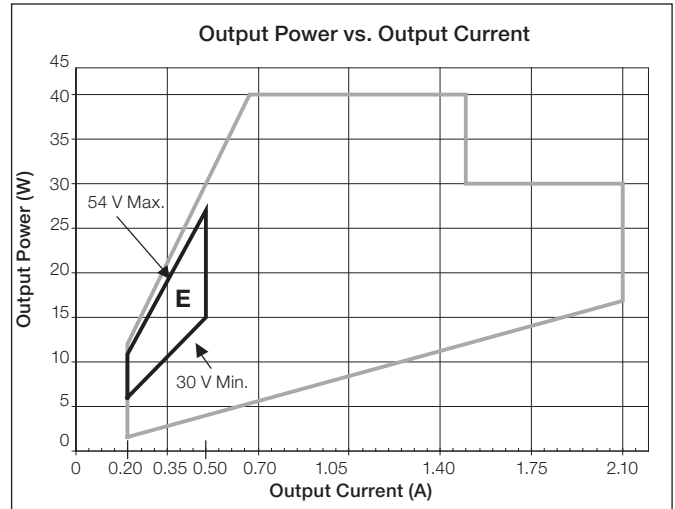
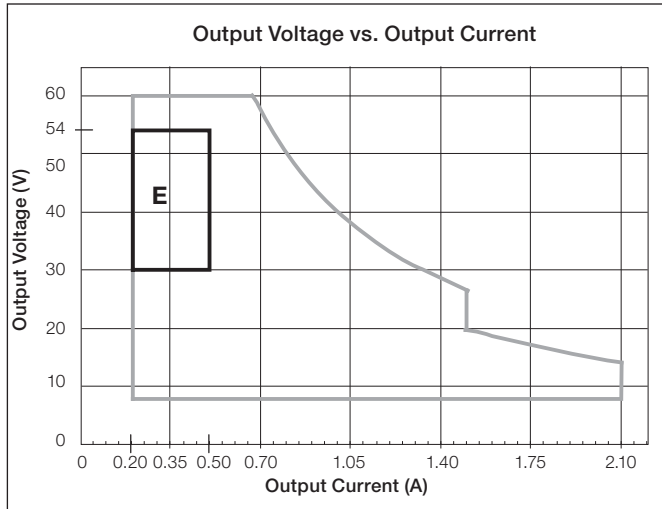

Typical Performance Specifications:

Parameter	120 V \sim	240 V \sim	277 V \sim	Test Conditions
Input Current	260 mA	140 mA	110 mA	t _a = 25 °C, 0.50 A 27 W load, Maximum Light Output, K-case
Power Factor	0.99	0.98	0.96	
THD	10%	10%	12%	
Driver Efficiency	85%	85%	85%	

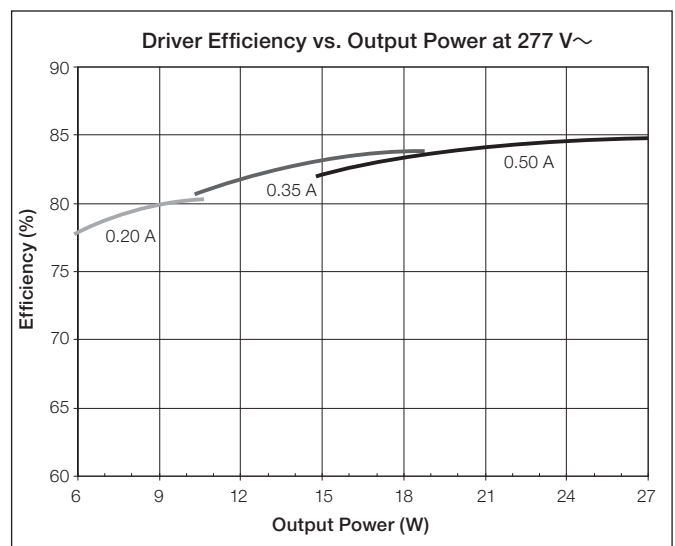
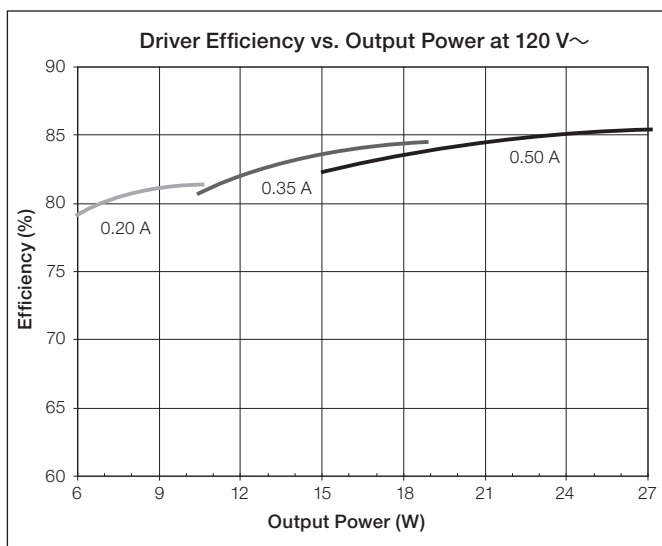

Job Name:	Model Numbers:
Job Number:	

“F” Output Range, Current Driver Models

Driver Type	Output Dimming Method	Output Voltage	Output Current	Output Power	Standards Recognition	UL® Listed Option (KL case)
Constant-Current Driver (Class 2)	Constant-Current Reduction (CCR)	30–54 V ⁻⁻⁻ *	0.51–1.00 A	15–40 W	 Type TL 83 °/66 °C - K-case Type TL 90 °/72 °C - M-case	Yes

When using QwikFig™ technology, these models can be built from the following bulk units:

K-case - L3DA4U1UKx-3ABLK**; M-case - L3DA4U1UMN-3ABLK

* Output parameter is power-limited for this output range. Consult detailed specifications on this page for the minimum and maximum voltage for each operating current.

** x = studded (S) or non-studded (N)

Current Driver Operation Range:

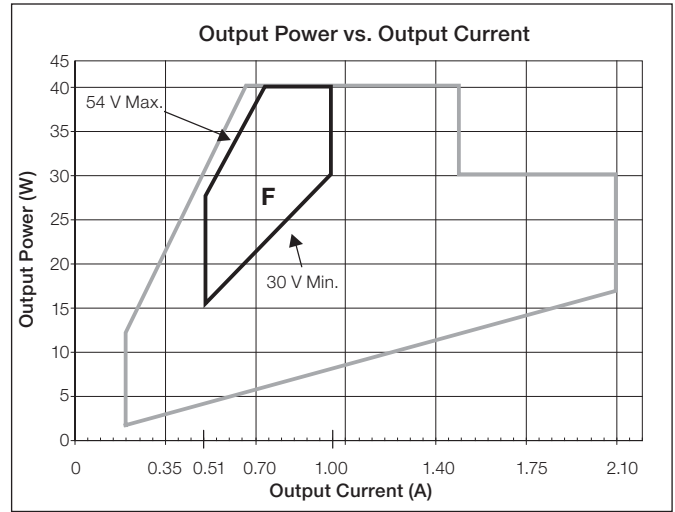
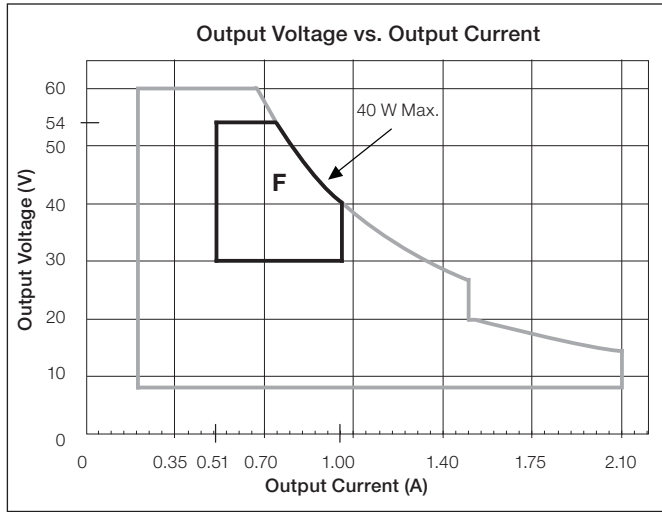

Typical Performance Specifications:

Parameter	120 V~	240 V~	277 V~	Test Conditions
Input Current	380 mA	200 mA	160 mA	t _a = 25 °C, 1.00 A 40 W load, Maximum Light Output, K-case
Power Factor	0.99	0.99	0.98	
THD	8%	9%	11%	
Driver Efficiency	84%	86%	86%	

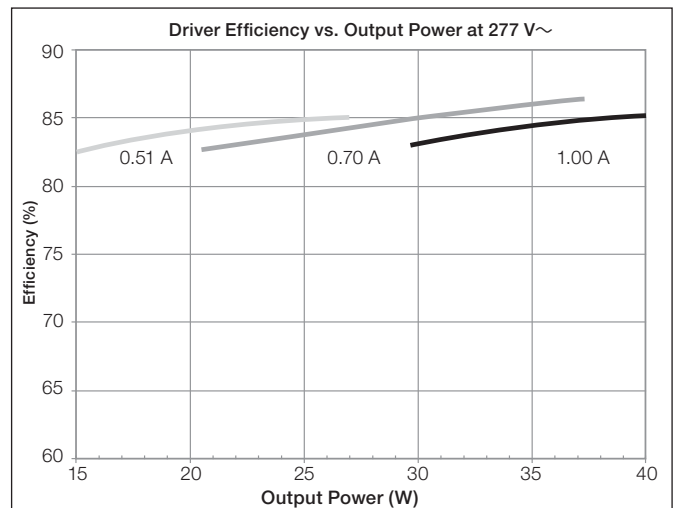
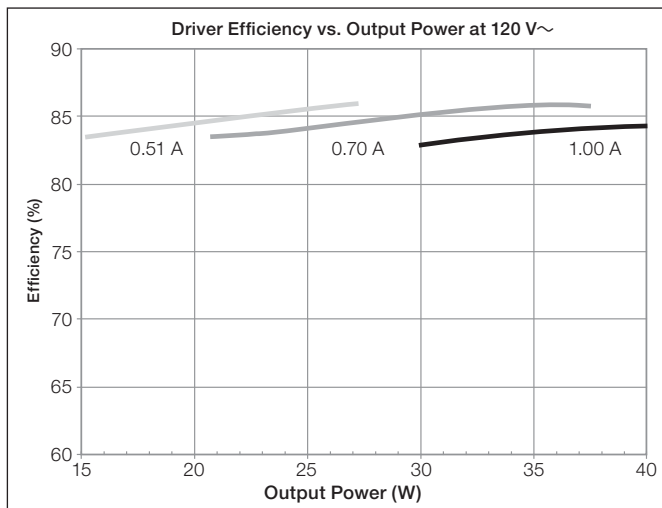

Job Name:	Model Numbers:
Job Number:	

“G” Output Range, Current Driver Models

Driver Type	Output Dimming Method	Output Voltage	Output Current	Output Power	Standards Recognition	UL® Listed Option (KL case)
Constant-Current Driver (Class 2)	Pulse Width Modulation (PWM)	8–20 V PWM	0.20–0.70 A	2–14 W	 Type TL 87 °/55 °C - K-case Type TL 89 °/68 °C - M-case	Yes
	Constant-Current Reduction (CCR)	8–20 V~				

When using QwikFig™ technology, these models can be built from the following bulk units:

K-case - L3DA4U1UKx-2GBLK*; M-case - L3DA4U1UMN-2CBLK

* x = studded (S) or non-studded (N)

Current Driver Operation Range:

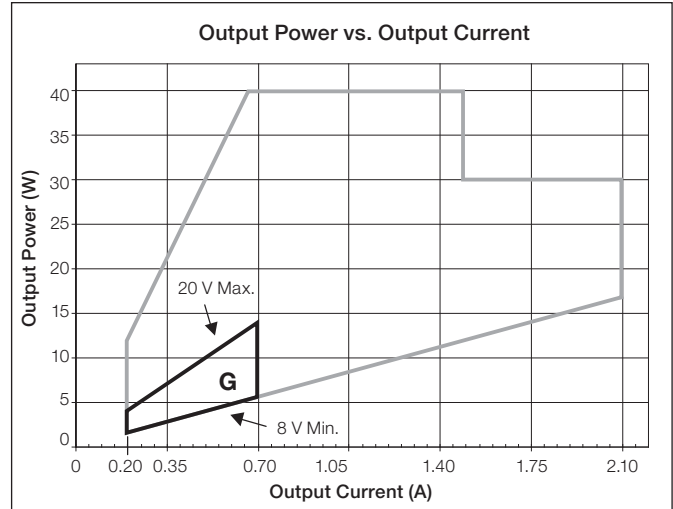
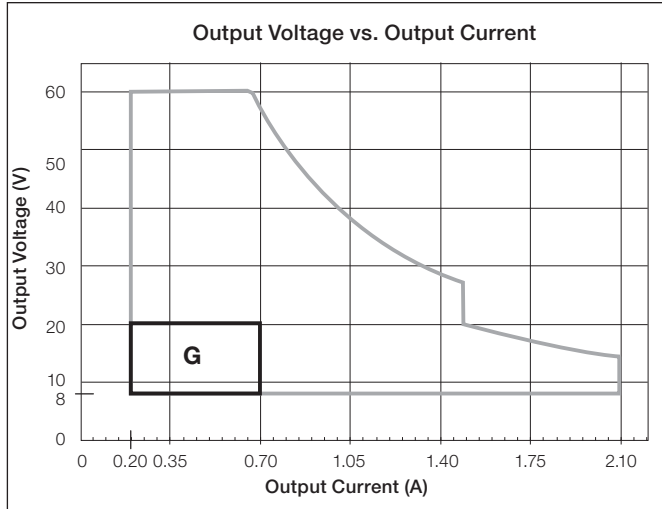

Typical Performance Specifications:

Parameter	120 V~	240 V~	277 V~	Test Conditions
Input Current	140 mA	90 mA	70 mA	t _a = 25 °C, 0.70 A 14 W load, Maximum Light Output, K-case
Power Factor	0.99	0.89	0.85	
THD	11%	16%	20%	
Driver Efficiency	80%	80%	79%	

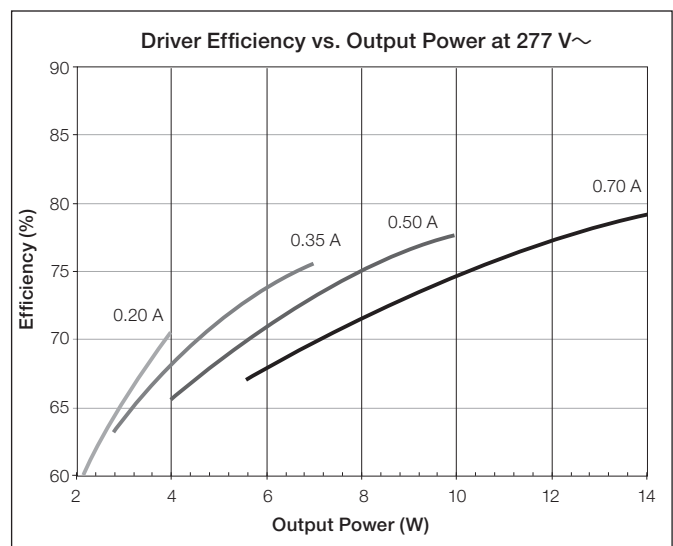
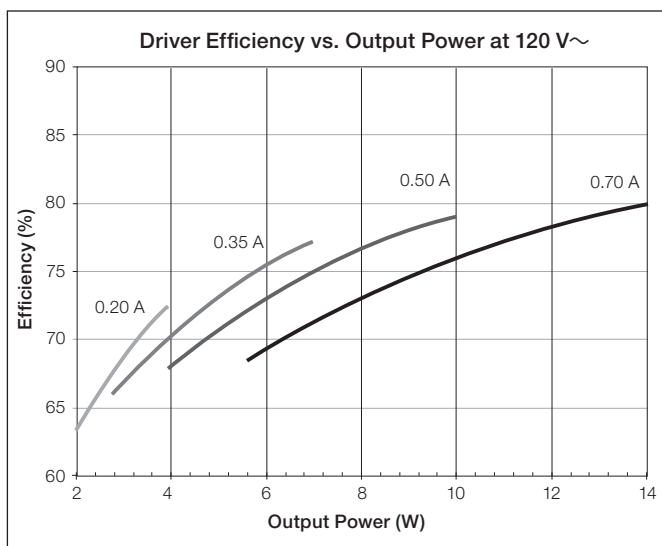

Job Name:	Model Numbers:
Job Number:	

“H” Output Range, Current Driver Models

Driver Type	Output Dimming Method	Output Voltage	Output Current	Output Power	Standards Recognition	UL® Listed Option (KL case)
Constant-Current Driver (Class 2)	Pulse Width Modulation (PWM)	15–38 V PWM	0.20–0.70 A	3–26.6 W	 Type TL 89 °/61 °C - K-case Type TL 89 °/74 °C - M-case	Yes
	Constant-Current Reduction (CCR)	15–38 V=				

When using QwikFig™ technology, these models can be built from the following bulk units:

K-case - L3DA4U1UKx-2HBLK*; M-case - L3DA4U1UMN-2BBLK

* x = studded (S) or non-studded (N)

Current Driver Operation Range:

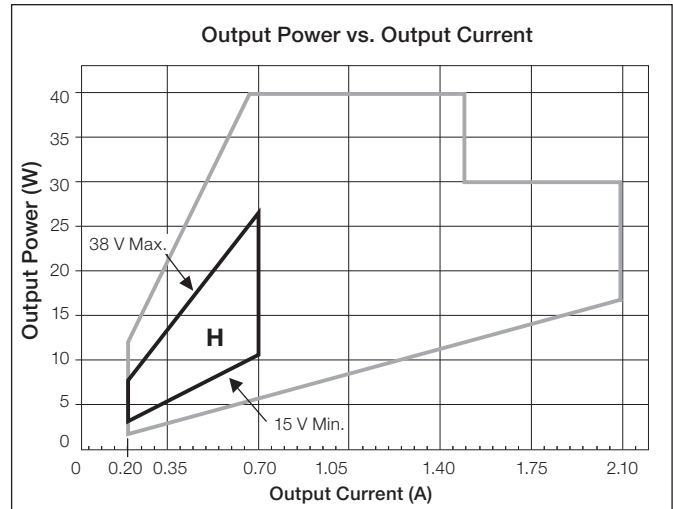
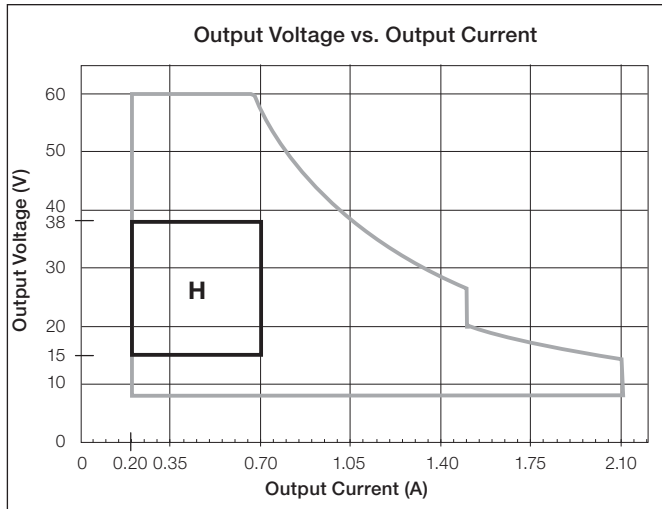

Typical Performance Specifications:

Parameter	120 V~	240 V~	277 V~	Test Conditions
Input Current	270 mA	140 mA	120 mA	t _a = 25 °C, 0.70 A 26 W load, Maximum Light Output, K-case
Power Factor	0.99	0.96	0.94	
THD	7%	10%	12%	
Driver Efficiency	84%	85%	85%	

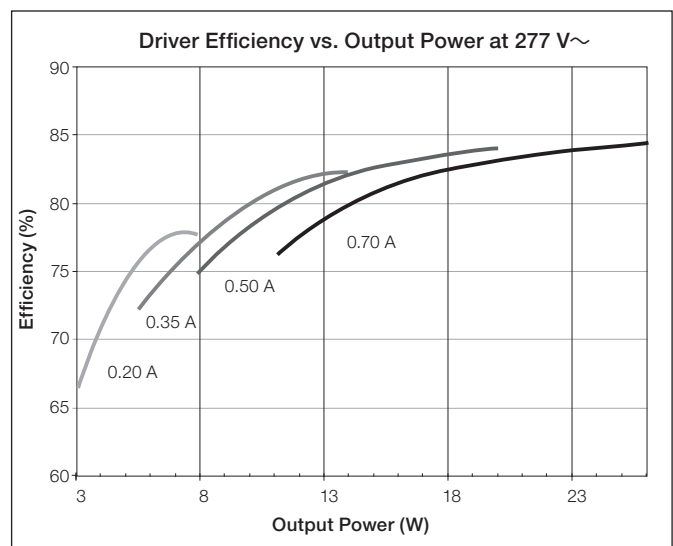
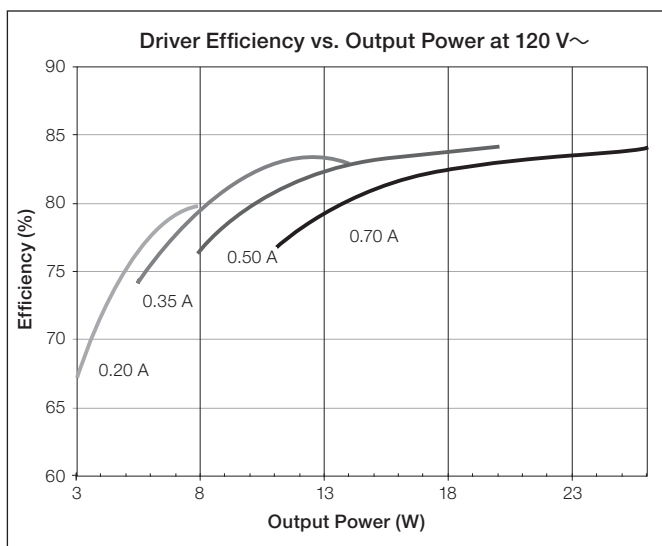

Job Name:	Model Numbers:
Job Number:	

"I" Output Range, Current Driver Models

Driver Type	Output Dimming Method	Output Voltage	Output Current	Output Power	Standards Recognition	UL® Listed Option (KL case)
Constant-Current Driver (Class 2)	Pulse Width Modulation (PWM)	8–20 V PWM	0.71–1.05 A	6–21 W	 Type TL 86 °/63 °C - K-case Type TL 89 °/68 °C - M-case	Yes
	Constant-Current Reduction (CCR)	8–20 V $\overline{=}$				

When using QwikFig™ technology, these models can be built from the following bulk units:

K-case - L3DA4U1UKx-2RBLK*; M-case - L3DA4U1UMN-2CBLK

* x = studded (S) or non-studded (N)

Current Driver Operation Range:

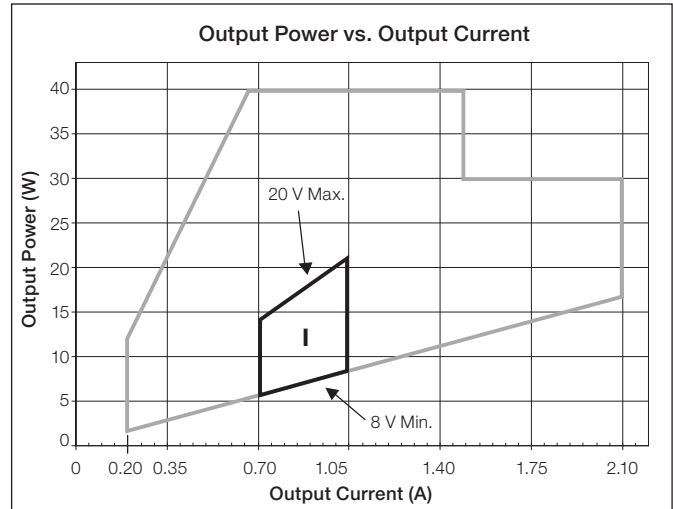
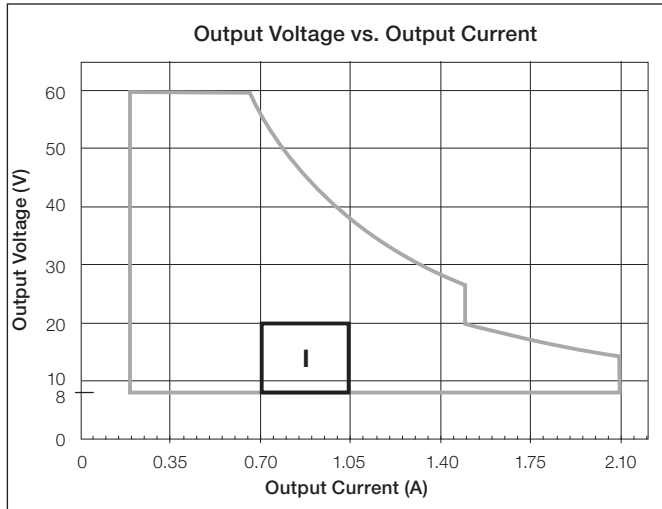

Typical Performance Specifications:

Parameter	120 V \sim	240 V \sim	277 V \sim	Test Conditions
Input Current	210 mA	120 mA	100 mA	t _a = 25 °C, 1.05 A 21 W load, Maximum Light Output, K-case
Power Factor	0.98	0.94	0.92	
THD	15%	13%	14%	
Driver Efficiency	82%	81%	81%	

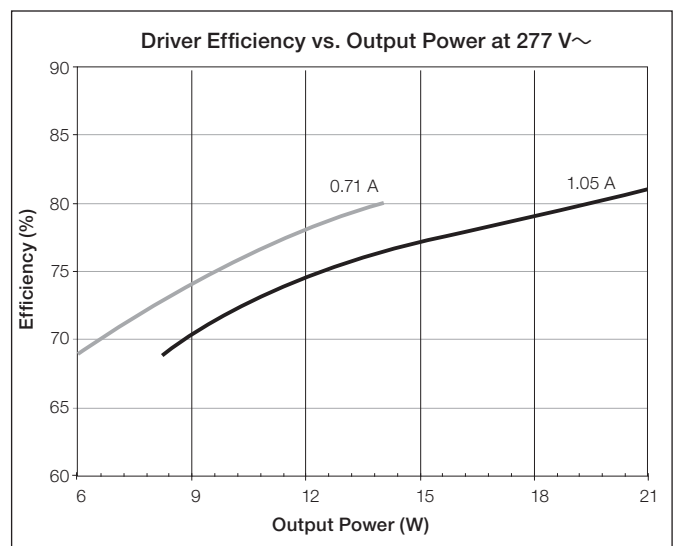
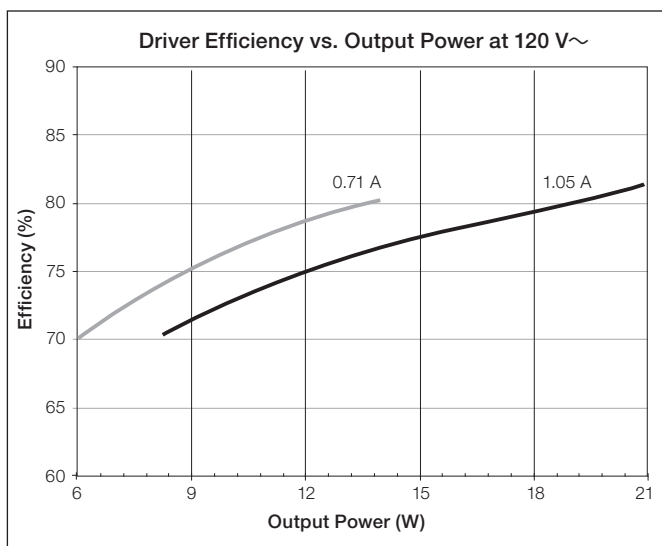

Job Name:	Model Numbers:
Job Number:	

“J” Output Range, Current Driver Models

Driver Type	Output Dimming Method	Output Voltage	Output Current	Output Power	Standards Recognition	UL® Listed Option (KL case)
Constant-Current Driver (Class 2)	Pulse Width Modulation (PWM)	15–38 V PWM	0.71–1.05 A	11–40 W	 Type TL 86 °/69 °C - K-case Type TL 89 °/74 °C - M-case	Yes
	Constant-Current Reduction (CCR)	15–38 V=				

When using QwikFig™ technology, these models can be built from the following bulk units:

K-case - L3DA4U1UKx-2SBLK*; M-case - L3DA4U1UMN-2BBLK

* x = studded (S) or non-studded (N)

Current Driver Operation Range:

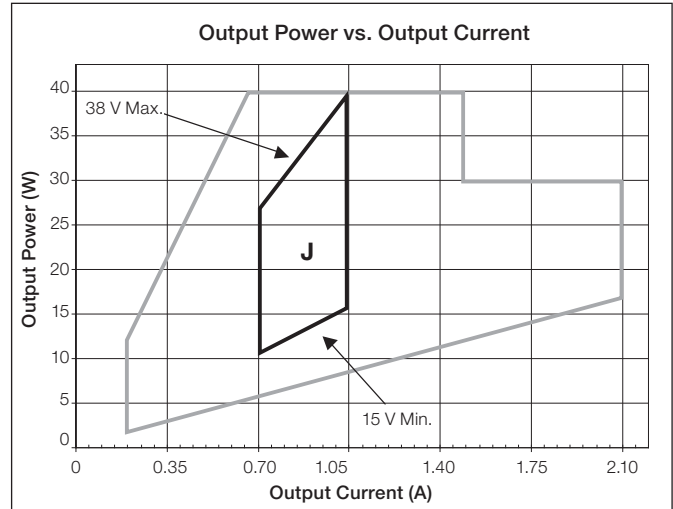
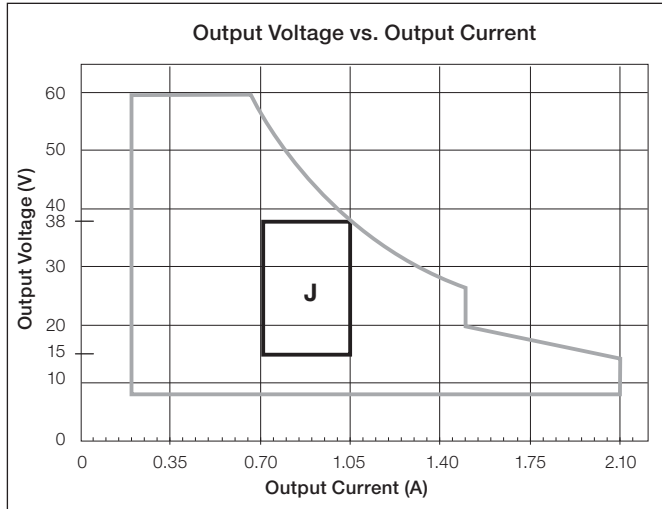

Typical Performance Specifications:

Parameter	120 V~	240 V~	277 V~	Test Conditions
Input Current	390 mA	200 mA	170 mA	t _a = 25 °C, 1.05 A 40 W load, Maximum Light Output, K-case
Power Factor	0.99	0.98	0.97	
THD	6%	9%	10%	
Driver Efficiency	85%	86%	86%	

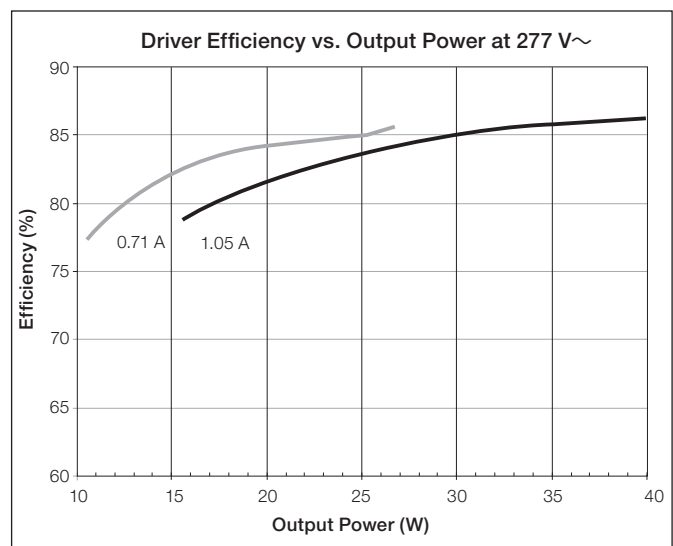
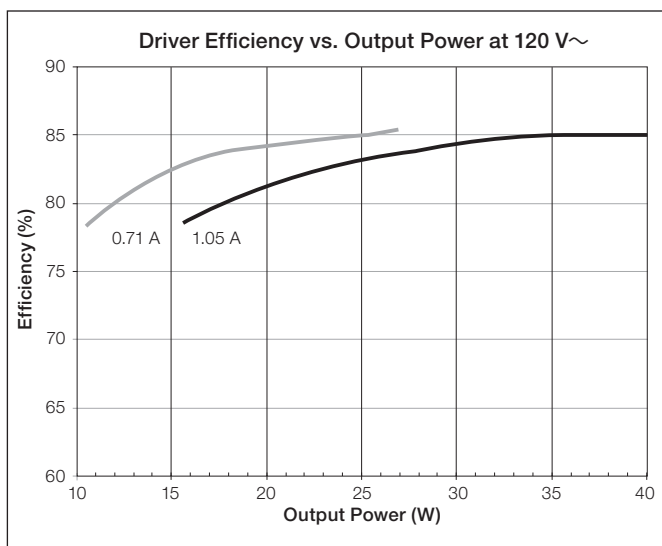

Job Name:	Model Numbers:
Job Number:	

“K” Output Range, Current Driver Models

Driver Type	Output Dimming Method	Output Voltage	Output Current	Output Power	Standards Recognition	UL® Listed Option (KL case)
Constant-Current Driver (Class 2)	Pulse Width Modulation (PWM)	8–20 V PWM	1.06–1.50 A	9–30 W	 Type TL 86 °/63 °C - K-case Type TL 89 °/68 °C - M-case	Yes
	Constant-Current Reduction (CCR)	8–20 V \approx				

When using QwikFig™ technology, these models can be built from the following bulk units:

K-case - L3DA4U1UKx-2RBLK*; M-case - L3DA4U1UMN-2CBLK

* x = studded (S) or non-studded (N)

Current Driver Operation Range:

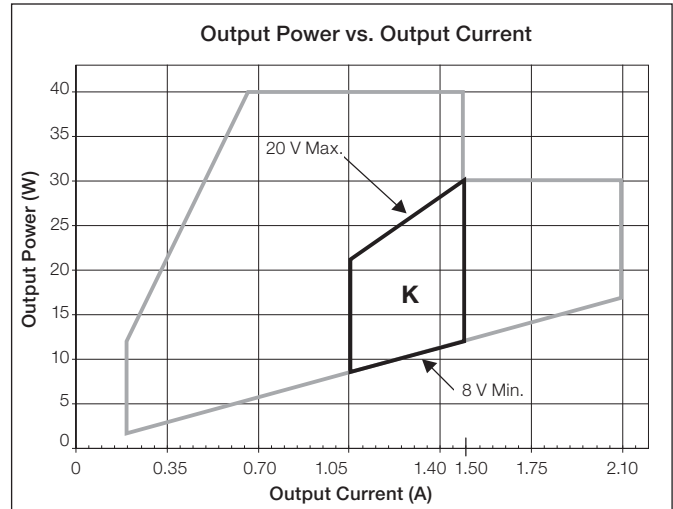
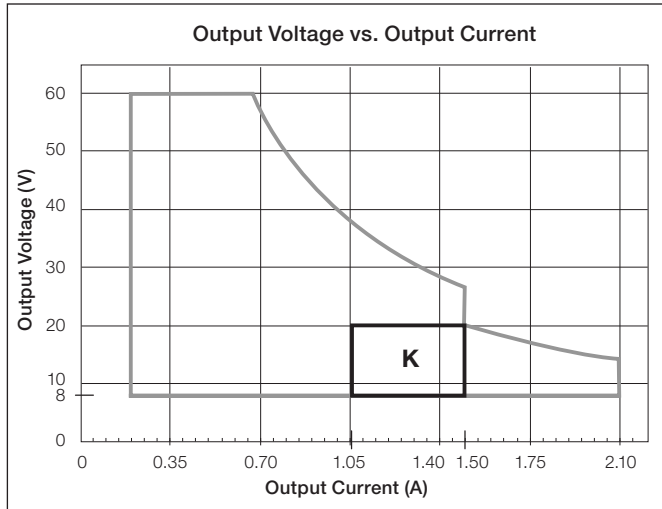

Typical Performance Specifications:

Parameter	120 V~	240 V~	277 V~	Test Conditions
Input Current	310 mA	160 mA	130 mA	t _a = 25 °C, 1.50 A 30 W load, Maximum Light Output, K-case
Power Factor	0.99	0.96	0.94	
THD	15%	17%	15%	
Driver Efficiency	81%	83%	82%	

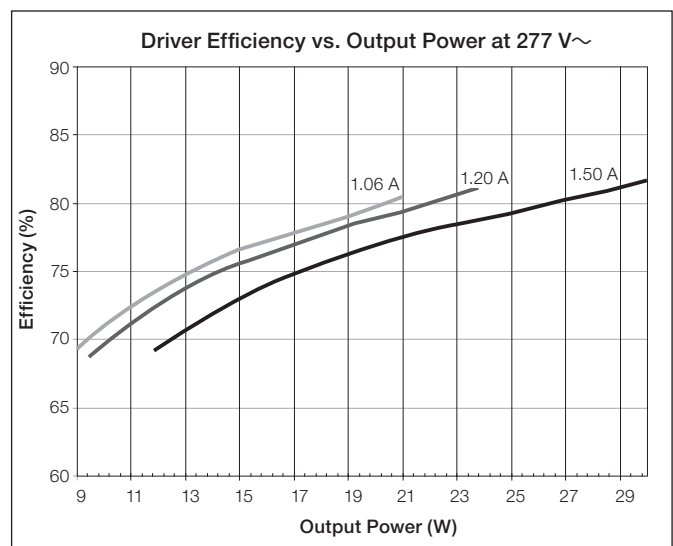
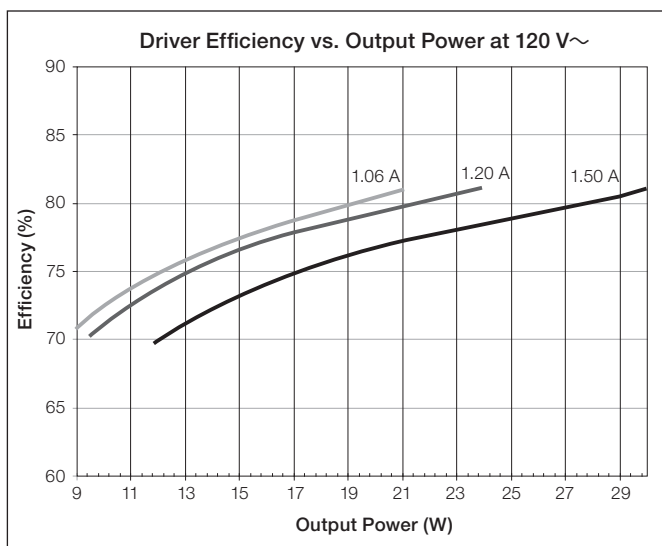

Job Name:	Model Numbers:
Job Number:	

“L” Output Range, Current Driver Models

Driver Type	Output Dimming Method	Output Voltage	Output Current	Output Power	Standards Recognition	UL® Listed Option (KL case)
Constant-Current Driver (Class 2)	Pulse Width Modulation (PWM)	15–38 V PWM*	1.06–1.50 A	16–40 W	 Type TL 86 °/69 °C - K-case Type TL 89 °/74 °C - M-case	Yes
	Constant-Current Reduction (CCR)	15–38 V~*				

When using QwikFig™ technology, these models can be built from the following bulk units:

K-case - L3DA4U1UKx-2SBLK**; **M-case** - L3DA4U1UMN-2BBLK

* Output parameter is power-limited for this output range. Consult detailed specifications on this page for the minimum and maximum voltage for each operating current.

** x = studded (S) or non-studded (N)

Current Driver Operation Range:

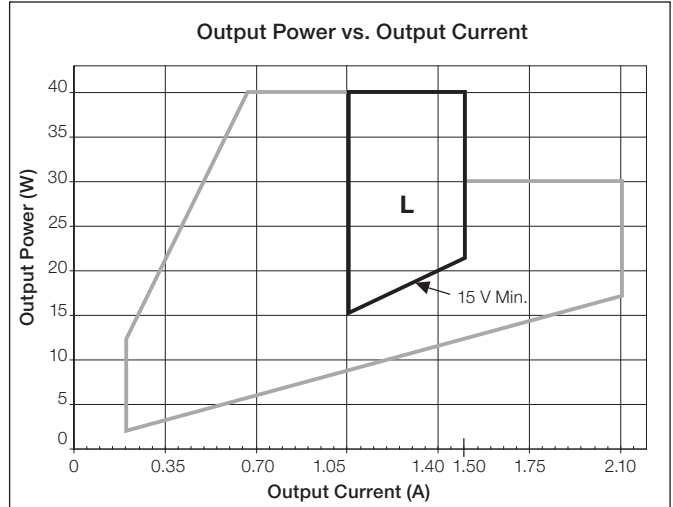
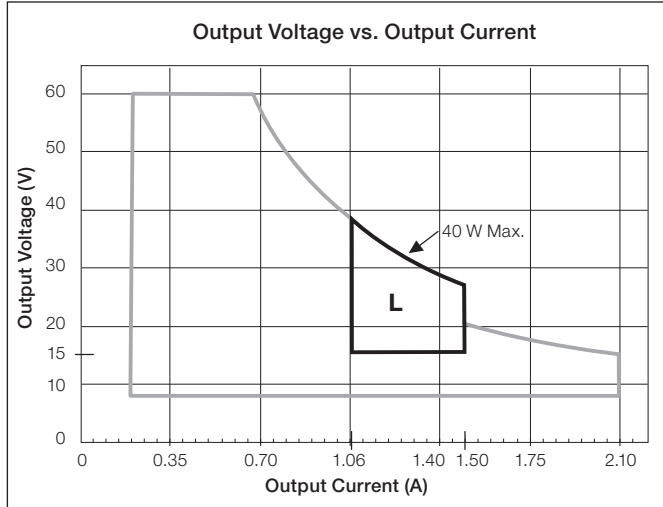

Typical Performance Specifications:

Parameter	120 V~	240 V~	277 V~	Test Conditions
Input Current	390 mA	200 mA	180 mA	t _a = 25 °C, 1.50 A 40 W load, Maximum Light Output, K-case
Power Factor	0.99	0.97	0.96	
THD	9%	13%	12%	
Driver Efficiency	83%	85%	85%	

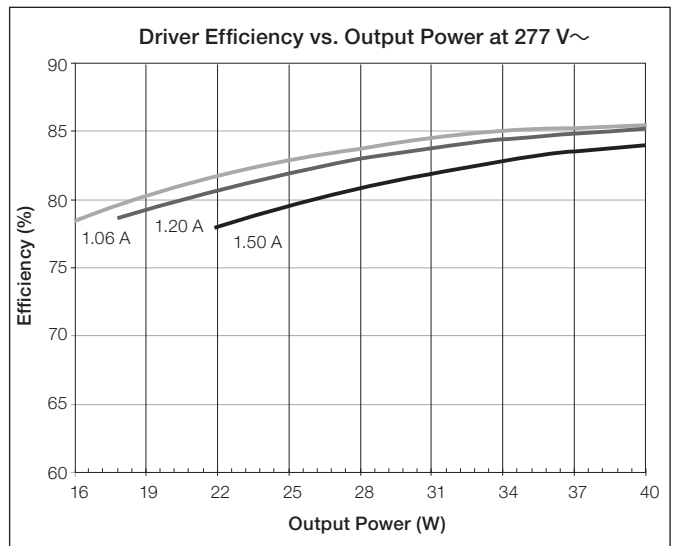
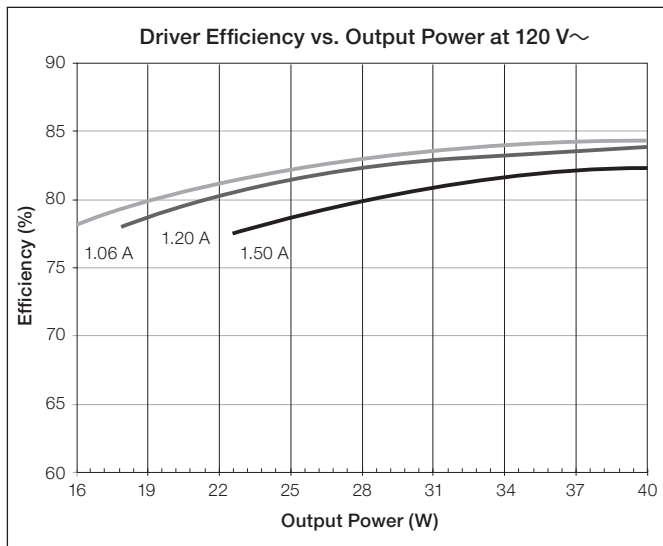

Job Name:	Model Numbers:
Job Number:	

“N” Output Range, Current Driver Models

Driver Type	Output Dimming Method	Output Voltage	Output Current	Output Power	Standards Recognition	UL® Listed Option (KL case)
Constant-Current Driver (Class 2)	Constant-Current Reduction (CCR)	35–54 V ⁻⁻⁻ *	0.71–1.05 A	25–53 W	 Type TL 87 °/71 °C - K-case	No

When using QwikFig™ technology, these models can be built from the following bulk unit:
K-case - L3DA5U1UKx-3BBLK**

- * Output parameter is power-limited for this output range. Consult detailed specifications on this page for the minimum and maximum voltage for each operating current.
- ** x = studded (S) or non-studded (N)

Current Driver Operation Range:

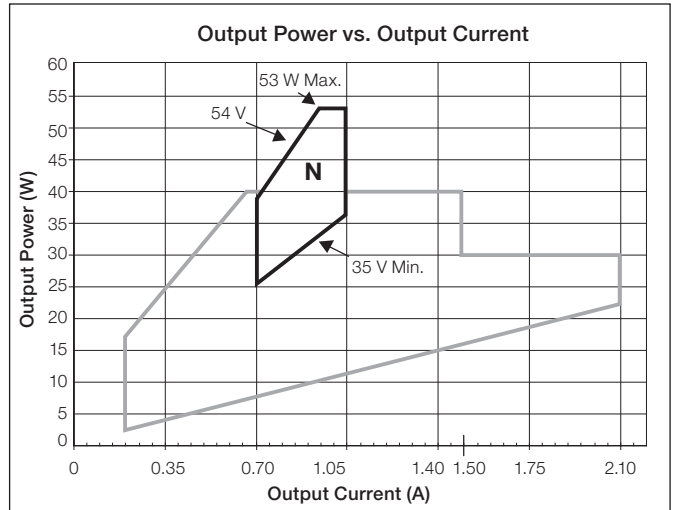
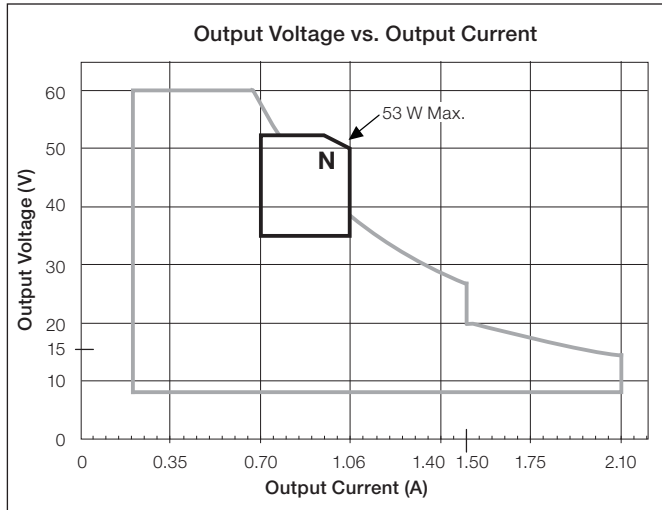

Typical Performance Specifications:

Parameter	120 V~	240 V~	277 V~	Test Conditions
Input Current	510 mA	255 mA	220 mA	t _a = 25 °C, 1.05 A 53 W load, Maximum Light Output, K-case
Power Factor	1.00	0.99	0.99	
THD	12%	10%	10%	
Driver Efficiency	83%	84%	85%	

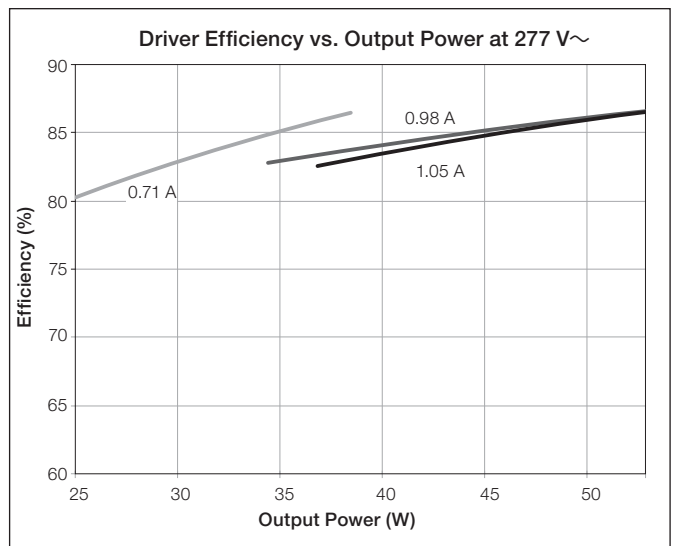
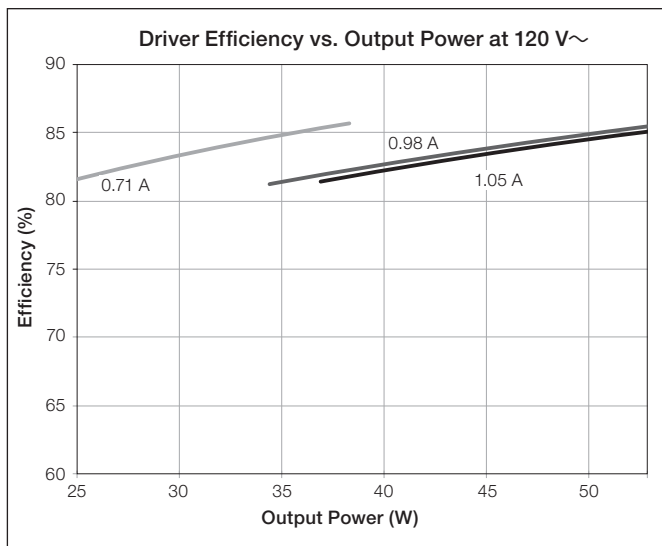

Job Name:	Model Numbers:
Job Number:	

K-Case: Case Dimensions

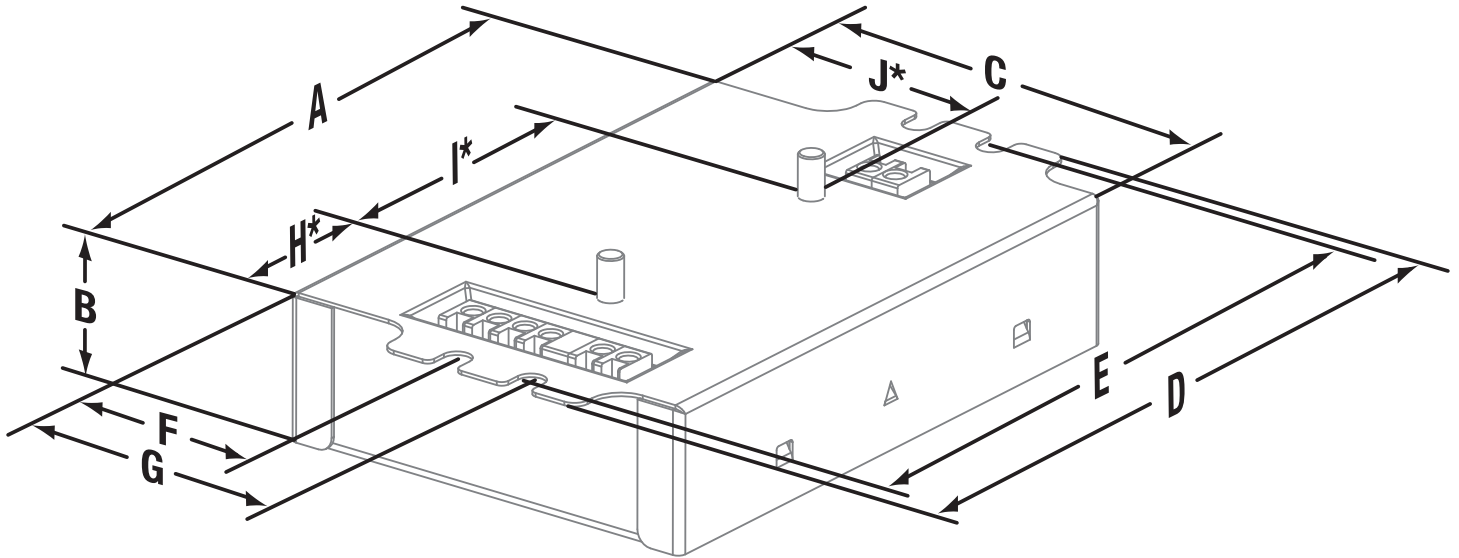

K-Case: Connector Location Dimensions

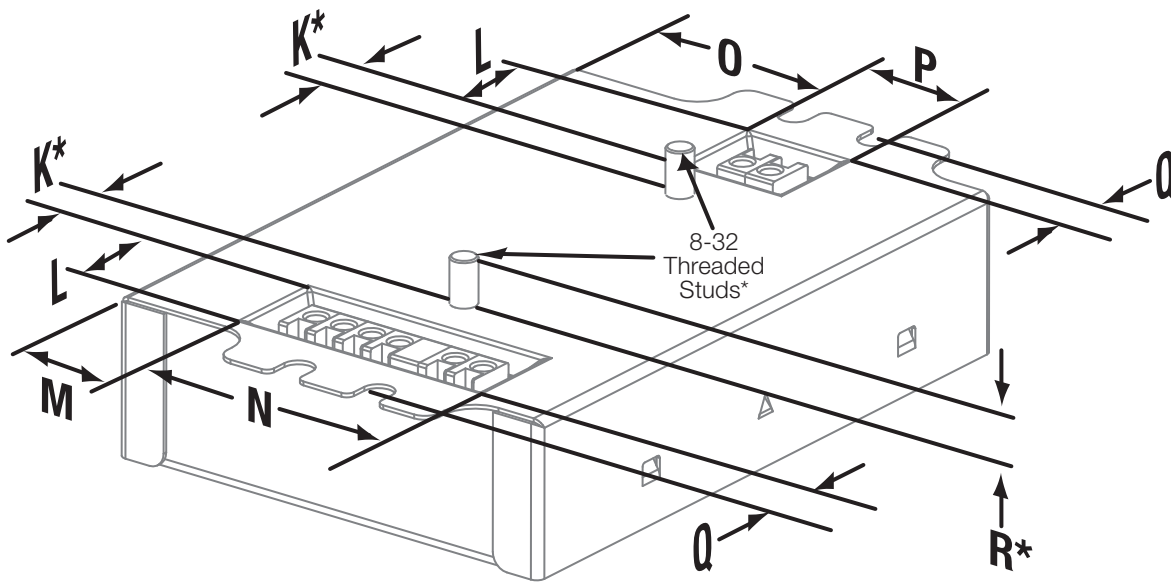

A	4.20 in (107 mm)	F	1.42 in (36 mm)	K*	0.33 in (8.3 mm)	P	0.74 in (19 mm)
B	1.00 in (25 mm)	G	1.99 in (51 mm)	L	0.65 in (16.5 mm)	Q	0.32 in (8 mm)
C	3.00 in (76 mm)	H*	1.11 in (28 mm)	M	0.75 in (19 mm)	R*	0.29 in (7 mm)
D	4.90 in (124 mm)	I*	2.00 in (51 mm)	N	1.73 in (44 mm)		
E	4.60 in (117 mm) (mounting center)	J*	1.60 in (41 mm)	O	1.33 in (34 mm)		

* Applies to studded K-case only.

Job Name:	Model Numbers:
Job Number:	

K-Case: Side Entry Connector Location Dimensions (Non-Studded)

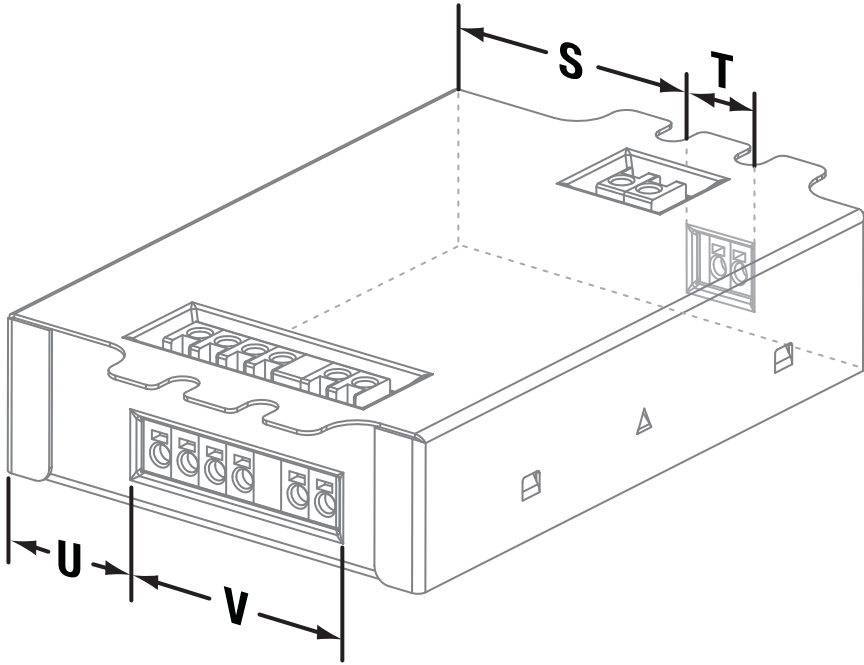

S	1.38 in (35 mm)
T	0.64 in (16 mm)
U	0.88 in (22 mm)
V	1.53 in (39 mm)

M-Case: Case Dimensions

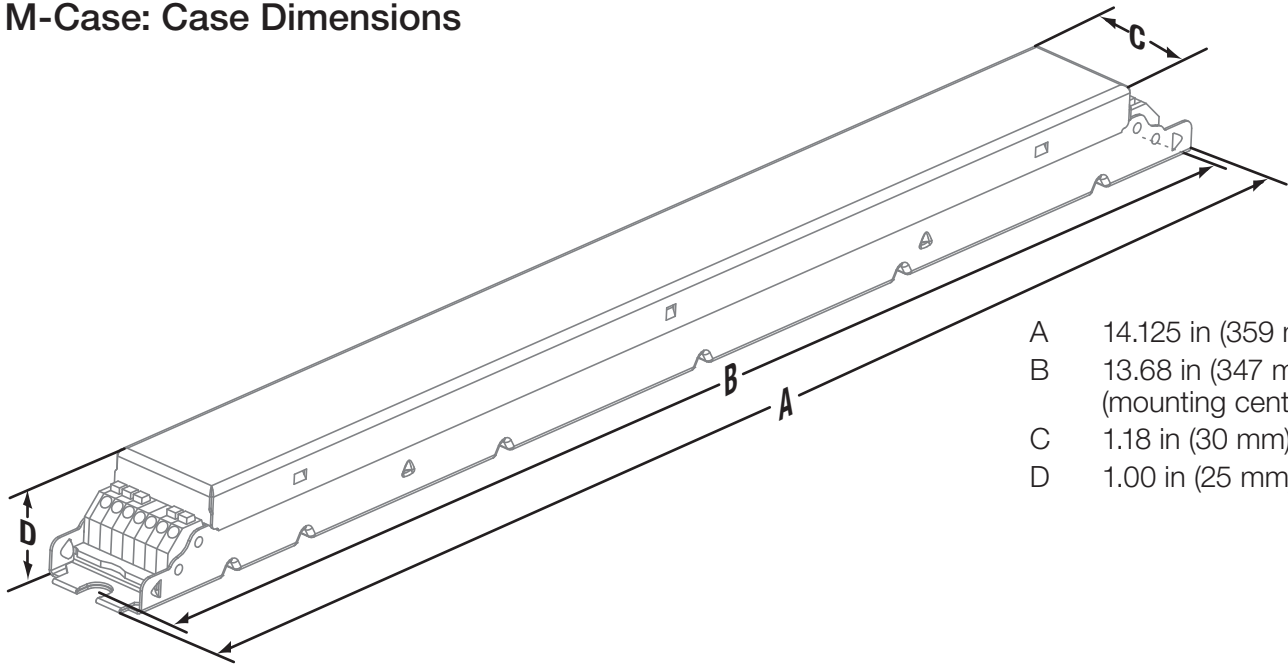

A	14.125 in (359 mm)
B	13.68 in (347 mm) (mounting center)
C	1.18 in (30 mm)
D	1.00 in (25 mm)

Job Name:	Model Numbers:
Job Number:	

Wiring Diagram for 3-Wire Control

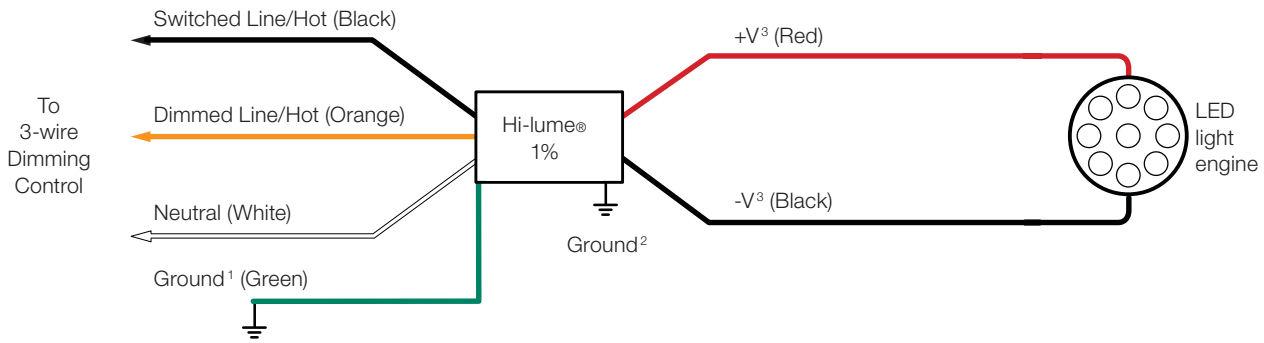

Wiring Diagram for EcoSystem® Digital Control

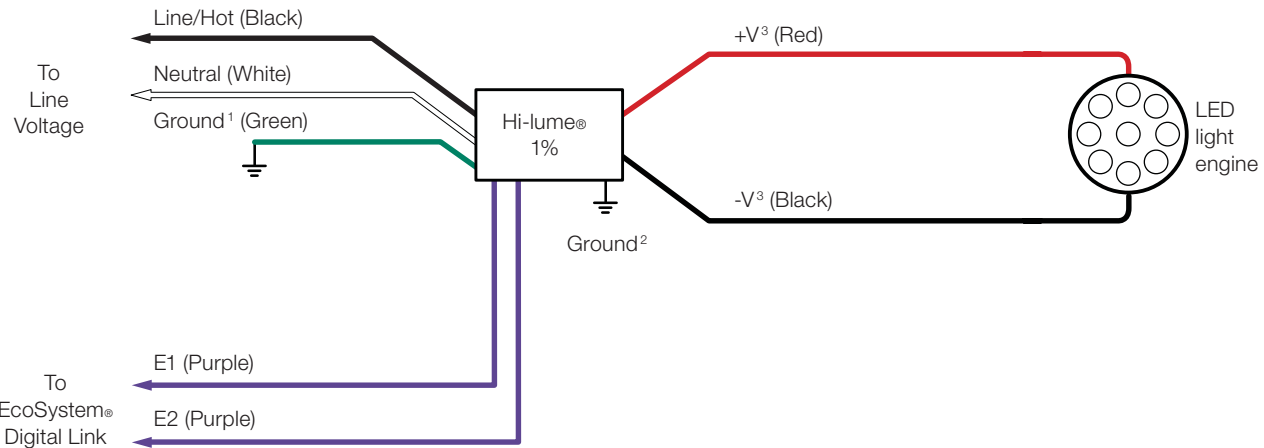

Note: Colors shown correspond to terminal blocks on driver.

¹ Ground wire connection available on K-case models only.
² Fixture and driver case must be grounded in accordance with local and national electrical codes.
³ For maximum driver-to-LED light engine wire length, see charts in **Driver Leads** section at the end of the document.

Job Name:	Model Numbers:
Job Number:	

Compatible Controls

- Guaranteed performance specifications with the controls listed in the chart below.
- For assistance selecting controls, contact our LED Center of Excellence at 1.877.346.5338 or LEDs@lutron.com

Product	Part Number		Drivers per Control				Measured Light Output Range
			40 W Driver		50 W Driver		
	120 V~	277 V~	120 V~	277 V~	120 V~	277 V~	
3-wire Controls: Requires 3rd wire for control signal, see 3-wire diagram on previous page							
Nova T [☆]	NTF-10-	NTF-10-277-	1-41	1-44	1-31	1-36	100%-1%
	NTF-103P-	NTF-103P-277-	1-20	1-33	1-15	1-27	100%-1%
Nova®	NF-10-	NF-10-277-	1-41	1-44	1-31	1-36	100%-1%
	NF-103P-	NF-103P-277-	1-20	1-33	1-15	1-27	100%-1%
Skylark®	SF-10P-	SF-12P-277-	1-20	1-33	1-15	1-27	100%-1%
	SF-103P-	SF-12P-277-3	1-20	1-33	1-15	1-27	100%-1%
Diva®	DVF-103P-	DVF-103P-277-	1-20	1-33	1-15	1-27	100%-1%
	DVSCF-103P-	DVSCF-103P-277-	1-20	1-33	1-15	1-27	100%-1%
Ariadni®	AYF-103P-	AYF-103P-277-	1-20	1-44	1-15	1-27	100%-1%
Maestro®	MAF-6AM-	MAF-6AM-277-	1-15	1-20	1-11	1-20	100%-1%
	MSCF-6AM-	MSCF-6AM-277-	1-15	1-20	1-11	1-20	100%-1%
Maestro Wireless®	MRF2-F6AN-DV-		1-15	1-33	1-11	1-27	100%-1%
RadioRA® 2	RRD-F6AN-DV-		1-15	1-33	1-11	1-27	100%-1%
HomeWorks® QS	HQRD-F6AN-DV		1-15	1-33	1-11	1-27	100%-1%
Interfaces ¹	PHPM-3F-120	-	1-41	-	1-31	-	100%-1%
	PHPM-3F-DV		1-41	1-88	1-31	1-72	100%-1%
GP Dimming Panels	Various		1-41	1-88	1-31	1-72	100%-1%
EcoSystem® Controls: See EcoSystem® Controls wiring diagram on previous page							
PowPak® dimming module with EcoSystem®	RMJ-ECO32-DV-B		32 per EcoSystem® link				100%-1%
	FCJ-ECO		3 per EcoSystem® link ²				100%-1%
Energi Savr Node™ with EcoSystem®	QSN-1ECO-S, QSN-2ECO-S		64 per EcoSystem® link				100%-1%
GRAFIK Eye® QS with EcoSystem®	QSGRJ-_E, QSGR-_E	-	64 per EcoSystem® link				100%-1%
Quantum®	Various		64 per EcoSystem® link				100%-1%

¹ For use with 3-wire controls or Commercial Systems, RadioRA® 2 Systems or Home Systems applications.

² Up to 3 drivers controlled as a single zone (broadcast EcoSystem®).

Job Name:	Model Numbers:
Job Number:	

EcoSystem® Wiring Diagrams

EcoSystem® Digital Link Overview

- The EcoSystem® Digital Link wiring (E1 and E2) connects the digital ballasts and drivers together to form a lighting control system.
- Each EcoSystem® Digital Link supports up to 64 digital ballasts, LED drivers or EcoSystem® Modules (e.g. C5-BMJ-16A, C5-XPJ-16A), 32 occupancy sensors (64 occupancy sensors with Energi Savr Node™ with EcoSystem®), 16 daylight sensors, and 64 wallstations or IR receivers.*
- Sensors do not directly connect to Hi-lume® 1% EcoSystem™/3-Wire LED drivers.
- E1 and E2 (EcoSystem® digital link wires) are polarity insensitive and can be wired in any topology.
- An Energi Savr Node™ unit with EcoSystem®, GRAFIK Eye® QS control unit with EcoSystem®, PowPak® dimming module with EcoSystem®, or Quantum® system provides power for the EcoSystem® Digital Link and supports system programming.*
- All EcoSystem® Digital Link programming is completed by using the Energi Savr app for *Apple iPad*, *iPod Touch* or *iPhone* mobile digital devices, GRAFIK Eye® QS with EcoSystem®, PowPak® dimming module with EcoSystem®, or Quantum® system.

EcoSystem® Digital Link Wiring

- Driver EcoSystem® Digital Link terminals only accept one 18 AWG to 16 AWG (0.75 mm² to 1.5 mm²) solid copper wire per terminal.
- Make sure that the supply breaker to the Digital Driver and EcoSystem® Digital Link Supply is OFF when wiring.
- Connect the two conductors to the two Digital Driver terminals E1 and E2 as shown.
- Using two different colors for E1 and E2 will reduce confusion when wiring several drivers together.
- The EcoSystem® Digital Link may be wired Class 1 or Class 2. Consult applicable electrical codes for proper wiring practices.

* PowPak® dimming module with EcoSystem® provides power for the EcoSystem® Digital Link and can support 32 digital ballasts, LED drivers or EcoSystem® Modules, 6 Wireless Occupancy Sensors, 1 Wireless Daylight Sensor, and 9 Pico® Wireless Controllers.

Apple, iPad, iPod Touch, and iPhone are trademarks of Apple Inc., registered in the U.S. and other countries.

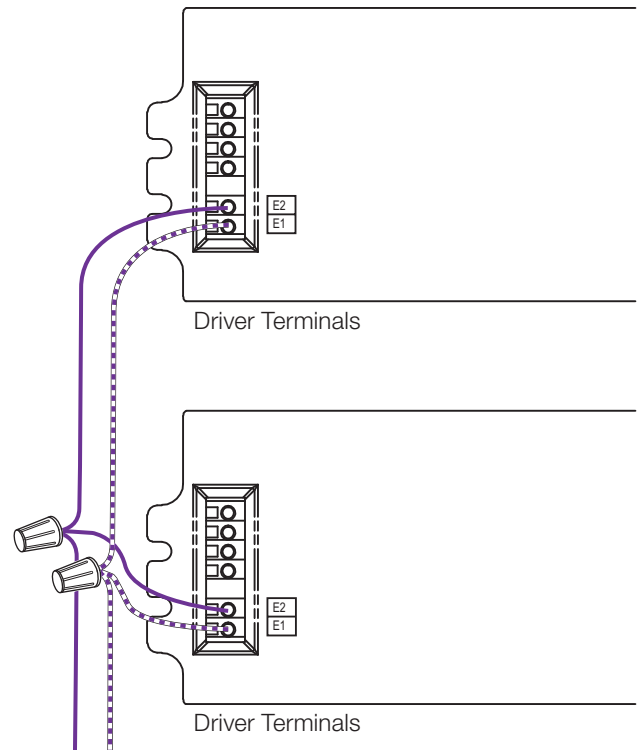

To the EcoSystem® Digital Bus and additional drivers and/or ballasts

Notes

- The EcoSystem® Digital Link Supply does not have to be located at the end of the Digital Link.
- EcoSystem® Digital Link length is limited by the wire gauge used for E1 and E2 as follows:

Wire Gauge	Digital Link Length (max)
12 AWG	2200 ft
14 AWG	1400 ft
16 AWG	900 ft
18 AWG	550 ft

Wire Size	Digital Link Length (max)
4.0 mm ²	828 m
2.5 mm ²	517 m
1.5 mm ²	310 m
1.0 mm ²	207 m
0.75 mm ²	155 m

Job Name:	Model Numbers:
Job Number:	

ELECTRICIANS AND CONTRACTORS

Driver Leads

Maximum driver-to-LED light engine wire length for
Constant-Current Drivers:

Wire Gauge	Maximum Lead Length		
	200 mA to 700 mA	710 mA to 1.50 A	1.51 A to 2.10 A
18 AWG (0.75 mm ²)	30 ft (9 m)	15 ft (4.5 m)	10 ft (3 m)
16 AWG (1.5 mm ²)	35 ft (10.5 m)	25 ft (7.5 m)	15 ft (4.5 m)
14 AWG (2.5 mm ²)	50 ft (15 m)	40 ft (12 m)	25 ft (7.5 m)
12 AWG (4.0 mm ²)	100 ft (30 m)	60 ft (18 m)	40 ft (12 m)

Maximum driver-to-LED light engine wire length for
Constant-Voltage Drivers:

Wire Gauge	Maximum Lead Length		
	10 V to 20 V	20.5 V to 40 V	40.5 V to 60 V
18 AWG (0.75 mm ²)	10 ft (3 m)	15 ft (4.5 m)	30 ft (9 m)
16 AWG (1.5 mm ²)	15 ft (4.5 m)	25 ft (7.5 m)	50 ft (15 m)
14 AWG (2.5 mm ²)	25 ft (7.5 m)	40 ft (12 m)	75 ft (22.5 m)
12 AWG (4.0 mm ²)	40 ft (12 m)	60 ft (18 m)	100 ft (30 m)

* Terminal blocks on the drivers accept only solid 18 or 16 AWG (0.75 or 1.5 mm²) wire. To use wire gauges larger than this terminal blocks' rated gauge of 18 or 16 AWG (0.75 or 1.5 mm²) refer to the Terminal Wiring Gauges diagram at the end of this document. Connect up to 3 ft (0.9 m) of 18 or 16 AWG (0.75 or 1.5 mm²) wire to the LED driver terminal blocks, then connect 14 or 12 AWG (2.5 or 4.0 mm²) up to the length allowed in the above table Wiring and Grounding.

Driver and lighting fixture must be grounded.

Drivers must be installed per national and local electrical codes.

LED Load Replacement

For Class 2 rated drivers, the LED load can be changed while the driver is installed and powered.

Maximum Driver Operating Temperature

Driver case temperature (t_c) must not exceed UL® conditions of acceptability in end product.

For 50,000 hour lifetime, driver case temperature (t_c) must not exceed:

- 149 °F (65 °C) for 40 W drivers.
- 158 °F (70 °C) for 50 W drivers.

FACILITIES MANAGERS

NOTE: This equipment has been tested and found to comply with the limits for a Class A digital device, pursuant to part 15 of the FCC Rules. These limits are designed to provide reasonable protection against harmful interference when the equipment is operated in a commercial environment. This equipment generates, uses, and can radiate radio frequency energy and, if not installed and used in accordance with the instruction manual, may cause harmful interference to radio communications. Operation of this equipment in a residential area is likely to cause harmful interference in which case the user will be required to correct the interference at his own expense.

This device complies with part 15 of the FCC Rules. Operation is subject to the following two conditions: (1) This device may not cause harmful interference, and (2) this device must accept any interference received, including interference that may cause undesired operation.

SERVICE

Warranty

For warranty information, please visit www.lutron.com/ballastdriverwarranty

Replacement Parts

When ordering Lutron® replacement parts please provide the full model number. Consult Lutron® Technical Support if you have any questions.

Further Information

For further information, please visit us at www.lutron.com/hilume1led or contact our LED Control Center of Excellence at 1.877.346.5338 or LEDs@lutron.com

Job Name:	Model Numbers:
Job Number:	

Terminal Wiring Gauges

Wire colors shown correspond to terminal blocks on driver.

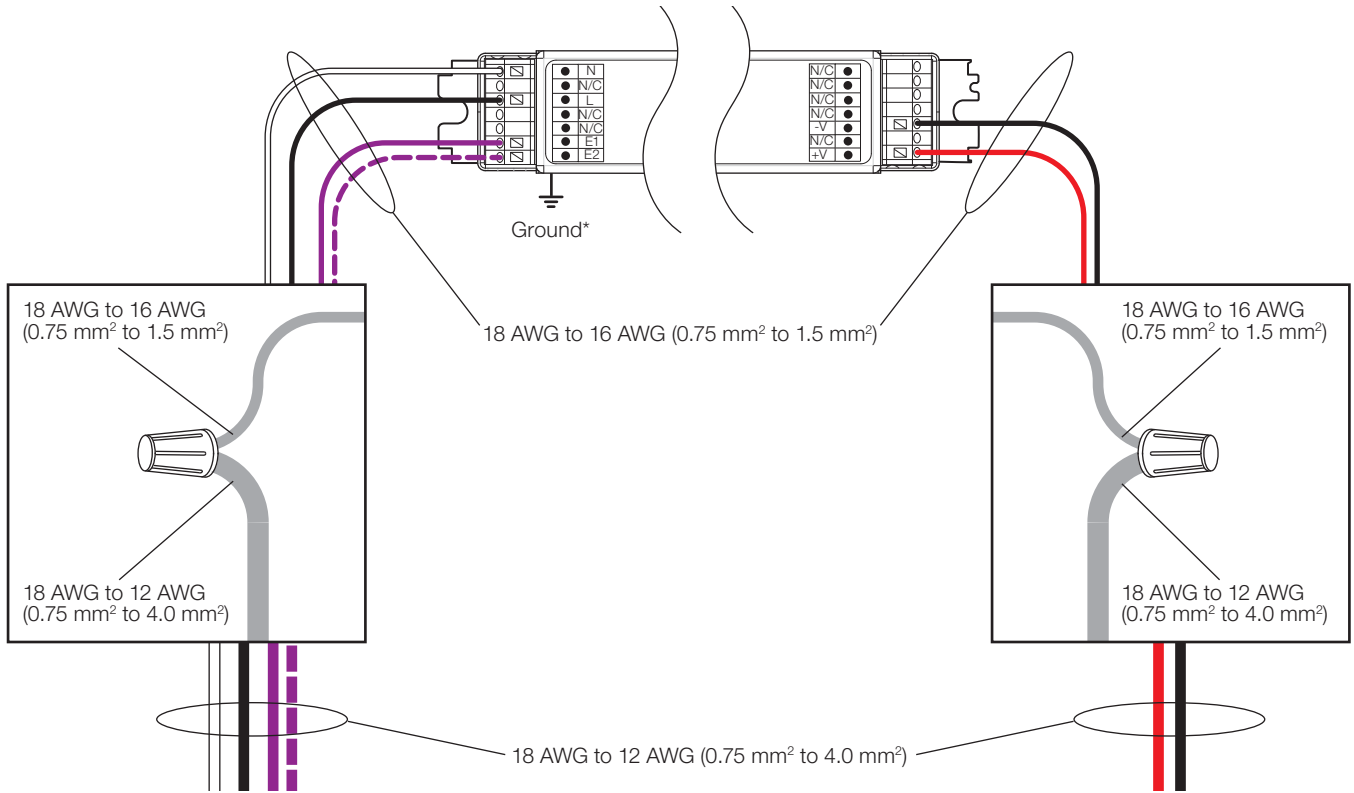

* Fixture and driver case must be grounded in accordance with local and national electrical codes. Ground connection to driver case can be accomplished through ground terminal, and/or grounding the case. Ground connection to M case driver (shown) requires connection to stud in fixture.

Job Name:	Model Numbers:
Job Number:	