

Hi-lume® 1% 2-Wire LED Driver Forward-Phase Control Overview

The Hi-lume® 1% 2-Wire LED Driver is a high-performance LED driver that provides smooth, continuous 1% dimming for virtually any LED fixture, whether it requires constant-current or constant-voltage. It is the most versatile LED driver offered today due to its compatibility with a wide variety of LED arrays, multiple form factors, and numerous control options.

Features

- Continuous, flicker-free dimming from 100% to 1%.¹
- Guaranteed compatibility with selected Maestro Wireless®, RadioRA® 2, HomeWorks® QS, GRAFIK Eye® QS, GRAFIK Systems™, Quantum®, and C•L® dimmers. Please see **Compatible Controls** chart or contact Lutron for details regarding compatible controls.
- QwikFig™ compatible. For more information please refer to Lutron® P/N 041473 (K and M case only).
- 100% performance tested at factory.
- A rated lifetime of 50,000 hours @ $t_c = 149^\circ\text{F}$ (65°C).
- UL® recognized and listed options for United States and Canada.
- Type TL Rated.²
- FCC Part 15 compliant for commercial and residential (UL® Listed only) applications at 120 V~.
- Pulse width modulation (PWM) or constant-current reduction (CCR) dimming methods available. See Application Note #360 for details.
- RoHS Compliant
- For more information please go to: www.lutron.com/hilume1led

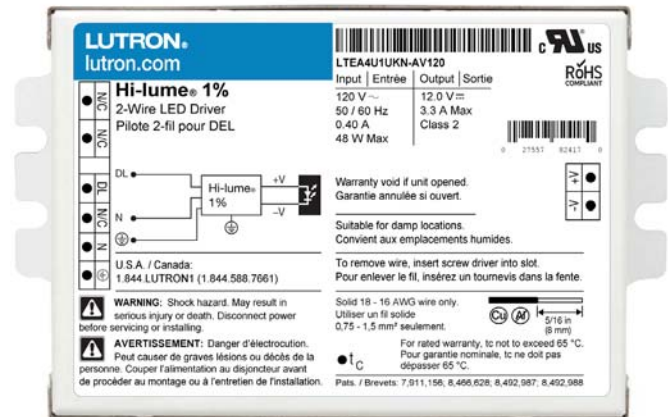

Case type K

3.00 in (76 mm) W x 1.00 in (25 mm) H x
4.90 in (124 mm) L



Case type M

1.18 in (30 mm) W x 1.00 in (25 mm) H x
14.25 in (362 mm) L



Case type KL

K-case mounted on a 4.00 in (102 mm) W x
1.50 in (38 mm) H x 4.00 in (102 mm) L junction
box to provide UL® listed wiring compartment

Page

¹ Light output at 1% depends on the efficacy of the light engine used with the driver.

² Type TL ratings are not offered for all output ranges. Consult detailed specifications on the following pages for availability.

LUTRON® SPECIFICATION SUBMITTAL

Job Name:	Model Numbers:
Job Number:	

Specifications

Regulatory Approvals

- Meets ANSI C62.41 category A surge protection standards up to and including 4 kV.
- FCC Part 15 compliant for commercial and residential (UL® Listed only) applications.
- Manufacturing facilities employ ESD reduction practices that comply with the requirements of ANSI/ESD S20.20.
- Lutron® Quality Systems registered to ISO 9001.2008.
- UL® 8750 recognized.
- UL® recognized models are also UL® classified to 1598C for field replacement capability.
- UL® 8750 listed form factor available.
- Class 2 output available.
- Type TL Rated.¹

UL® 8750 Listed Option

- cULus® for United States and Canada available for certain operating regions.
- Pre-wired and installation ready.
- See **KL Case: Case Dimensions** page for more specific details regarding UL® listed option.

Environmental

- Sound Rating: Inaudible in 27 dB ambient.
- Relative Humidity: Maximum 90% non-condensing.
- Minimum operating ambient temperature $t_a = 32\text{ °F}$ (0 °C).²

Performance

- Dimming Range: 100% to 1%.
- Operating Voltage: 120 V~ at 50/60 Hz
- Requires Forward Phase Control; please see **Compatible Controls** chart.
- A rated lifetime of 50,000 hours @ $t_c = 149\text{ °F}$ (65 °C).
 - For rated warranty, t_c not to exceed the maximum rated temperatures.³
- Patented thermal foldback protection.
- LEDs turn on to any dimmed level without going to full brightness.
- Non-volatile memory restores all driver settings after power failure.
- Power Factor: > 0.90 at 40 W.
- Total Harmonic Distortion (THD): $< 20\%$ at 40 W.
- Inrush Current: $< 2\text{ A}$.
- Inrush Current Limiting Circuitry: eliminates circuit breaker tripping, switch arcing and relay failure.
- Open circuit protected.
- Short circuit protected.
- Turn-on time: ≤ 1.5 seconds.⁴
- PWM Dimming Frequency: 550 Hz.

Driver Wiring & Mounting

- Driver is grounded by a mounting screw to the grounded fixture (or by terminal connection on the K case).
- Terminal blocks on the driver accept one solid wire per terminal from 18 AWG to 16 AWG (0.75 mm^2 to 1.5 mm^2).
- Fixture must be grounded in accordance with local and national electrical codes.
- For maximum driver-to-LED light engine wire length, see charts in **Driver Leads** section at the end of the document.

¹ Type TL ratings are not offered for all output ranges. Consult detailed specifications on the following pages for availability.

² Where t_a is the temperature of the air directly surrounding the driver.

³ Installer is responsible for ensuring that the driver case temperature does not exceed the maximum rated temperature.

⁴ Models available with turn-on time ≤ 1 second.

Job Name:	Model Numbers:
Job Number:	

How to Build a Model Number: Hi-lume® 1% 2-Wire LED Driver

LTEA4U1U

Case Size:

K = Compact
M = Stick

Case Style:

S = Studded (K case only)
N = Non-Studded
L = UL® Listed (K case only)

Example: LTEA4U1UKS-HC070

For further assistance selecting your model number, contact our LED Center of Excellence at 1.877.346.5338 or LEDs@lutron.com

Current Level (for Constant-Current):

020 = 0.20 A; 021 = 0.21 A...070 = 0.70 A...210 = 2.10 A

Voltage Level (for Constant-Voltage):

100 = 10.0 V; 105 = 10.5 V...600 = 60.0 V

Driver Output:

C = Constant-current driver with pulse width modulation (PWM) dimming
A = Constant-current driver with constant-current reduction (CCR) dimming
V = Constant-voltage driver with pulse width modulation (PWM) dimming

LED Load Output Range (see the following pages for more detail):

Class 2 Constant-Voltage

A = 10.0 V–12.0 V
B = 12.5 V–20.0 V*
C = 20.5 V–24.0 V*
D = 24.5 V–38.0 V*

Isolated Non-Class 2 Constant-Voltage

X = 38.5 V–60.0 V*

Class 2 Constant-Current

E = 0.20 A–0.50 A 30 V–54 V
F = 0.51 A–1.00 A 30 V–54 V*
G = 0.20 A–0.70 A 8 V–20 V
H = 0.20 A–0.70 A 15 V–38 V
I = 0.71 A–1.05 A 8 V–20 V
J = 0.71 A–1.05 A 15 V–38 V
K = 1.06 A–1.50 A 8 V–20 V
L = 1.06 A–1.50 A 15 V–38 V*
M = 1.51 A–2.10 A 8 V – 19.9 V*

Isolated Non-Class 2 Constant-Current

Y = 0.20 A–0.50 A 30 V–60 V
Z = 0.51 A–1.00 A 30 V–60 V*

* Output parameter is power-limited for these output ranges. Consult detailed specifications on the following pages for each range.

Job Name:	Model Numbers:
Job Number:	

How to Build a Bulk Model Number (For use with Lutron® QwikFig™ technology): Hi-lume® 1% 2-Wire LED Driver

LTEA4U1U - BLK

Case Size:

K = Compact
M = Stick

Case Style:¹

S = Studded
(K-case only)
N = Non-Studded
(All M-case models)

Bulk Models:

Coverage based on “LED Load Output Range” from standard non-configurable models shown in the **How to Build a Model Number** section. Example Standard Model Number: LTEA4U1UKS-**H**C070 has LED load output range = H

K-case and M-case

1A = Covers “LED Load Output Range” Y and Z
2A = Covers “LED Load Output Range” M
3A = Covers “LED Load Output Range” E and F (CCR dimming only)

K-case only

2G = Covers “LED Load Output Range” G
2H = Covers “LED Load Output Range” H
2R = Covers “LED Load Output Range” I and K
2S = Covers “LED Load Output Range” J and L

M-case only

2B = Covers “LED Load Output Range” H, J, and L
2C = Covers “LED Load Output Range” G, I, and K

Note: Only the model numbers falling into the structure listed above can be configured with QwikFig™. Standard model numbers configured at Lutron will not be capable of being reconfigured at another facility.

¹ QwikFig™ bulk drivers are only available as UL® recognized.

<p>Job Name:</p> <p>Job Number:</p>	<p>Model Numbers:</p>
--	------------------------------

“E” Output Range, Current Driver Models

Driver Type	Output Dimming Method	Output Voltage	Output Current	Output Power	Standards Recognition	UL® Listed Option (KL case)
Constant-Current Driver (Class 2)	Constant-Current Reduction (CCR)	30–54 V \equiv	0.20–0.50 A	6–27 W	 Type TL 82 °/74 °C - K-case Type TL 86 °/72 °C - M-case	Yes

When using QwikFig™ technology, these models can be built from the following bulk units:

K-case - LTEA4U1UKx-3ABLK*; M-case - LTEA4U1UMN-3ABLK

* x = studded (S) or non-studded (N)

Current Driver Operation Range:

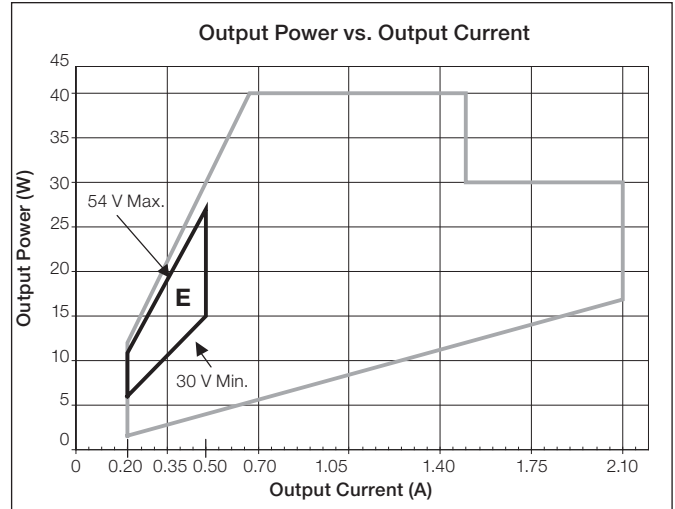
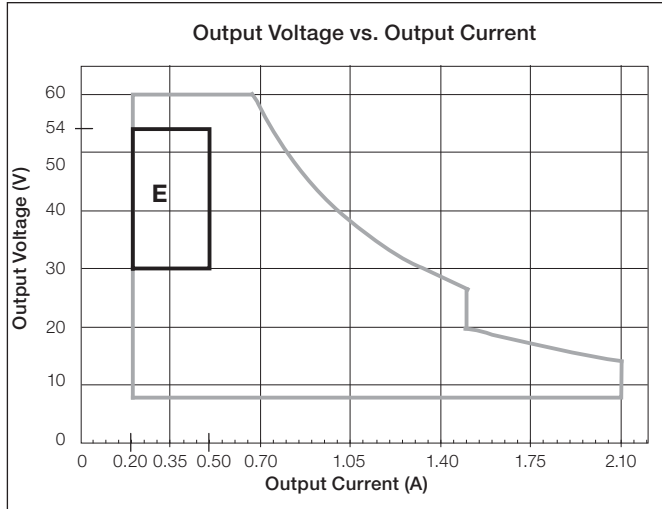

Typical Performance Specifications:

Parameter	Value	Test Conditions
Input Current	260 mA	$t_a = 25\text{ °C}$,
Power Factor	0.99	0.50 A 27 W load,
THD	10%	Maximum Light Output,
Driver Efficiency	83%	K case
		120 V \sim without a dimmer

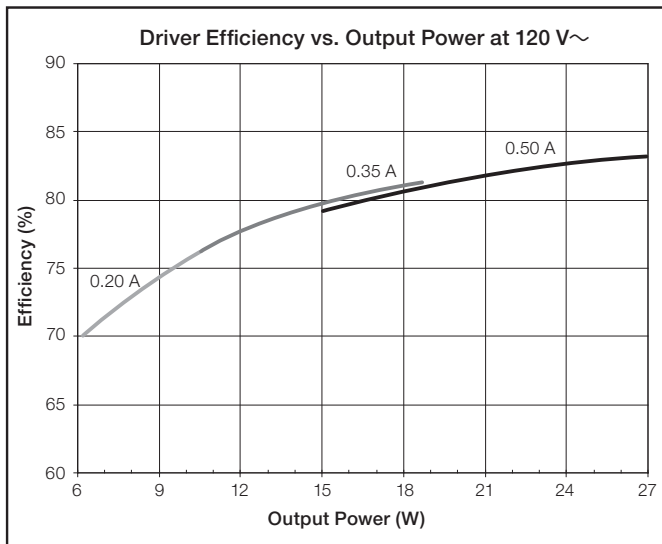

Job Name:	Model Numbers:
Job Number:	

“F” Output Range, Current Driver Models

Driver Type	Output Dimming Method	Output Voltage	Output Current	Output Power	Standards Recognition	UL® Listed Option (KL case)
Constant-Current Driver (Class 2)	Constant-Current Reduction (CCR)	30–54 V \equiv	0.51–1.00 A	15–40 W	 Type TL 82 °/74 °C - K-case Type TL 86 °/72 °C - M-case	Yes

When using QwikFig™ technology, these models can be built from the following bulk units:

K-case - LTEA4U1UKx-3ABLK*; M-case - LTEA4U1UMN-3ABLK

* x = studded (S) or non-studded (N)

Current Driver Operation Range:

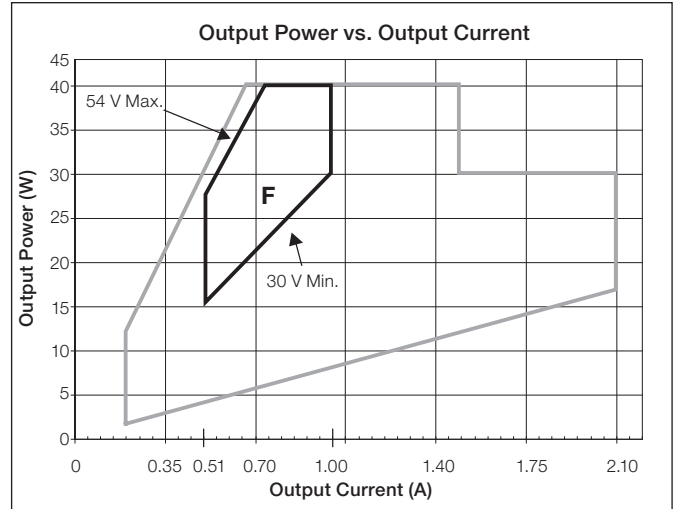
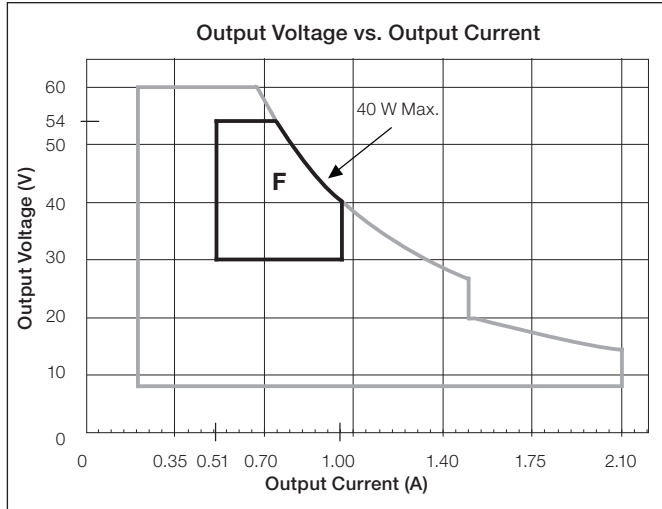

Typical Performance Specifications:

Parameter	Value	Test Conditions
Input Current	390 mA	$t_a = 25\text{ }^\circ\text{C}$, 1.00 A 40 W load, Maximum Light Output, K case 120 V \sim without a dimmer
Power Factor	0.99	
THD	7%	
Driver Efficiency	82%	

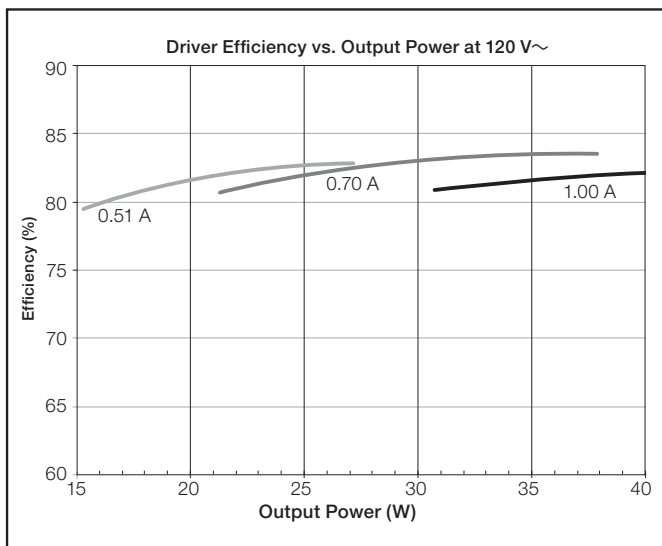

Job Name:	Model Numbers:
Job Number:	

“G” Output Range, Current Driver Models

Driver Type	Output Dimming Method	Output Voltage	Output Current	Output Power	Standards Recognition	UL® Listed Option (KL case)
Constant-Current Driver (Class 2)	Pulse Width Modulation (PWM)	8–20 V PWM	0.20–0.70 A	2–14 W	 Type TL 86 °/57 °C - K-case Type TL 90 °/69 °C - M-case	Yes
	Constant-Current Reduction (CCR)	8–20 V \sim				

When using QwikFig™ technology, these models can be built from the following bulk units:

K-case - LTEA4U1UKx-2GBLK*; M-case - LTEA4U1UMN-2CBLK

* x = studded (S) or non-studded (N)

Current Driver Operation Range:

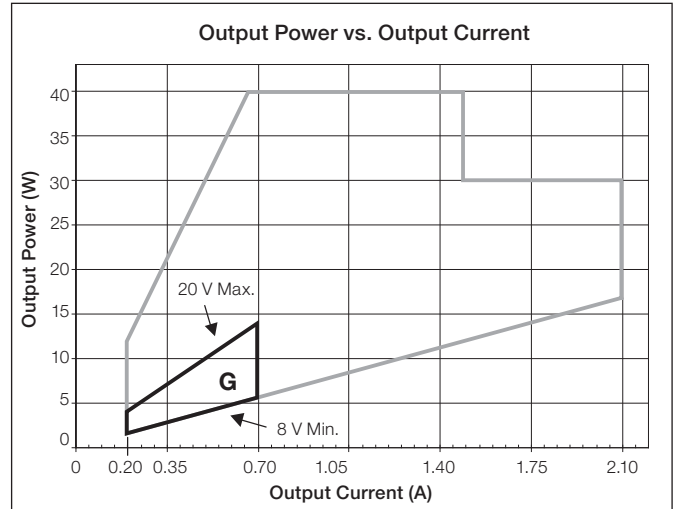
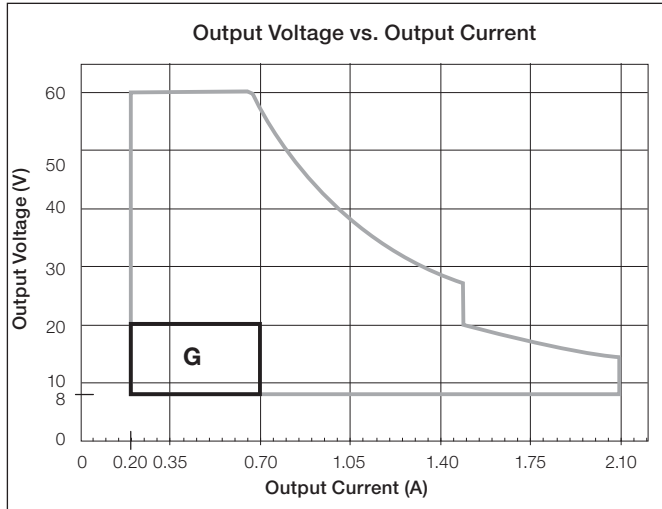

Typical Performance Specifications:

Parameter	Value	Test Conditions
Input Current	140 mA	$t_a = 25\text{ }^\circ\text{C}$, 0.70 A 14 W load, Maximum Light Output, K case 120 V \sim without a dimmer
Power Factor	0.99	
THD	12%	
Driver Efficiency	92%	

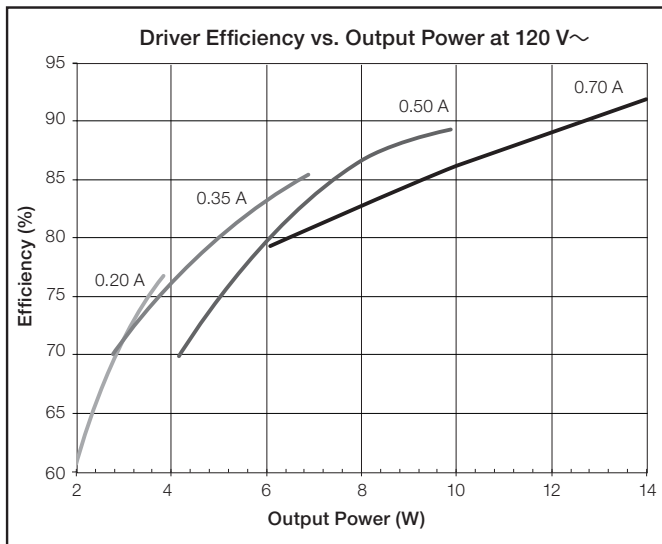

Job Name:	Model Numbers:
Job Number:	

“H” Output Range, Current Driver Models

Driver Type	Output Dimming Method	Output Voltage	Output Current	Output Power	Standards Recognition	UL® Listed Option (KL case)
Constant-Current Driver (Class 2)	Pulse Width Modulation (PWM)	15–38 V PWM	0.20–0.70 A	3–26.6 W	 Type TL 84 °/62 °C - K-case Type TL 86 °/78 °C - M-case	Yes
	Constant-Current Reduction (CCR)	15–38 V \sim				

When using QwikFig™ technology, these models can be built from the following bulk units:

K-case - LTEA4U1UKx-2HBLK*; M-case - LTEA4U1UMN-2BBLK

* x = studded (S) or non-studded (N)

Current Driver Operation Range:

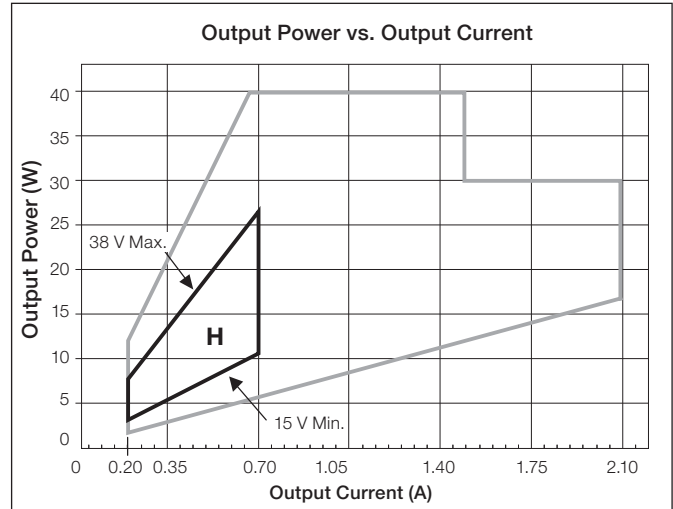
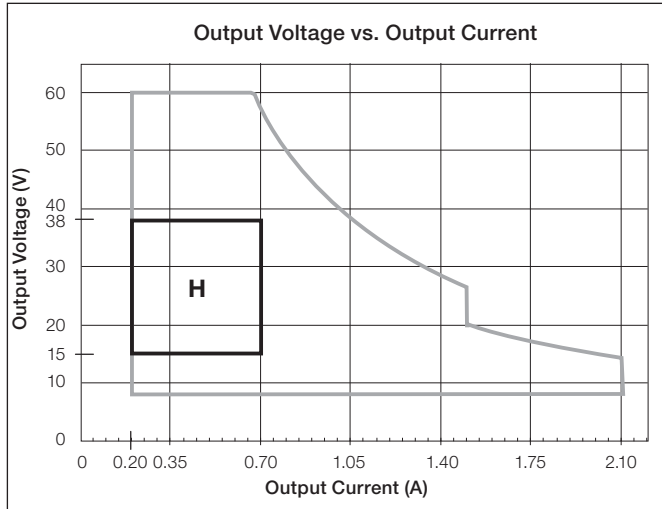

Typical Performance Specifications:

Parameter	Value	Test Conditions
Input Current	260 mA	$t_a = 25\text{ }^\circ\text{C}$,
Power Factor	0.99	0.70 A 26 W load,
THD	8%	Maximum Light Output,
Driver Efficiency	83%	K case
		120 V \sim without a dimmer

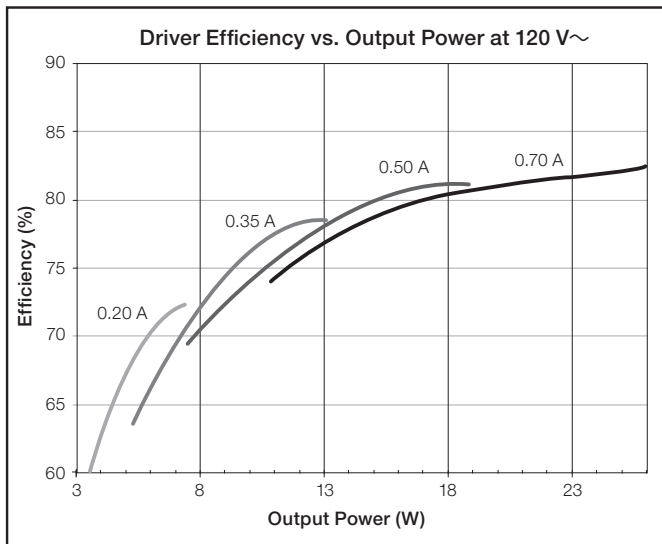

Job Name:	Model Numbers:
Job Number:	

"I" Output Range, Current Driver Models

Driver Type	Output Dimming Method	Output Voltage	Output Current	Output Power	Standards Recognition	UL® Listed Option (KL case)
Constant-Current Driver (Class 2)	Pulse Width Modulation (PWM)	8–20 V PWM	0.71–1.05 A	6–21 W	 Type TL 80 °/74 °C - K-case Type TL 90 °/69 °C - M-case	Yes
	Constant-Current Reduction (CCR)	8–20 V \sim				

When using QwikFig™ technology, these models can be built from the following bulk units:

K-case - LTEA4U1UKx-2RBLK*; M-case - LTEA4U1UMN-2CBLK

* x = studded (S) or non-studded (N)

Current Driver Operation Range:

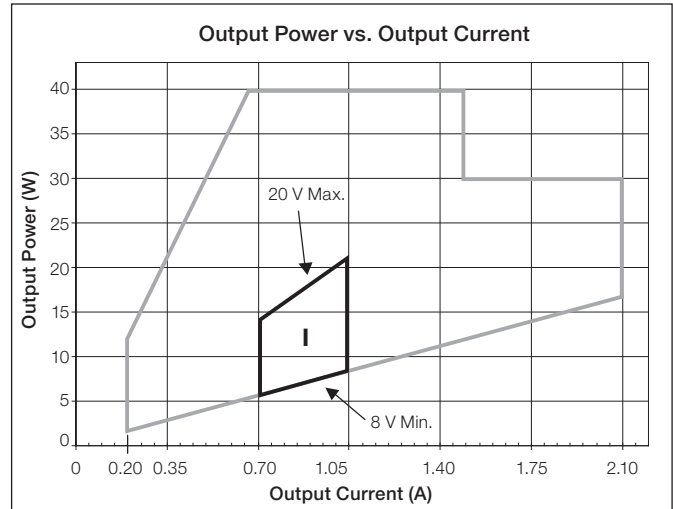
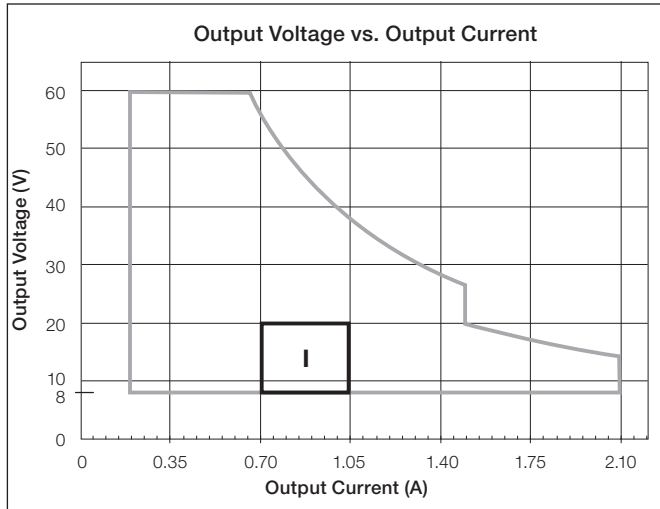

Typical Performance Specifications:

Parameter	Value	Test Conditions
Input Current	200 mA	$t_a = 25\text{ }^\circ\text{C}$,
Power Factor	0.99	1.05 A 21 W load,
THD	11%	Maximum Light Output,
Driver Efficiency	79%	K case
		120 V \sim without a dimmer

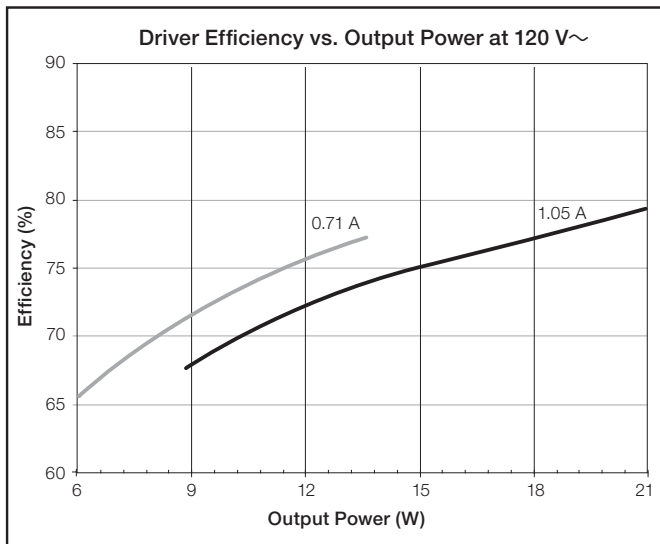

Job Name:	Model Numbers:
Job Number:	

“J” Output Range, Current Driver Models

Driver Type	Output Dimming Method	Output Voltage	Output Current	Output Power	Standards Recognition	UL® Listed Option (KL case)
Constant-Current Driver (Class 2)	Pulse Width Modulation (PWM)	15–38 V PWM	0.71–1.05 A	11–40 W	 Type TL 82 °/68 °C - K-case Type TL 86 °/78 °C - M-case	Yes
	Constant-Current Reduction (CCR)	15–38 V \sim				

When using QwikFig™ technology, these models can be built from the following bulk units:

K-case - LTEA4U1UKx-2SBLK*; M-case - LTEA4U1UMN-2BBLK

* x = studded (S) or non-studded (N)

Current Driver Operation Range:

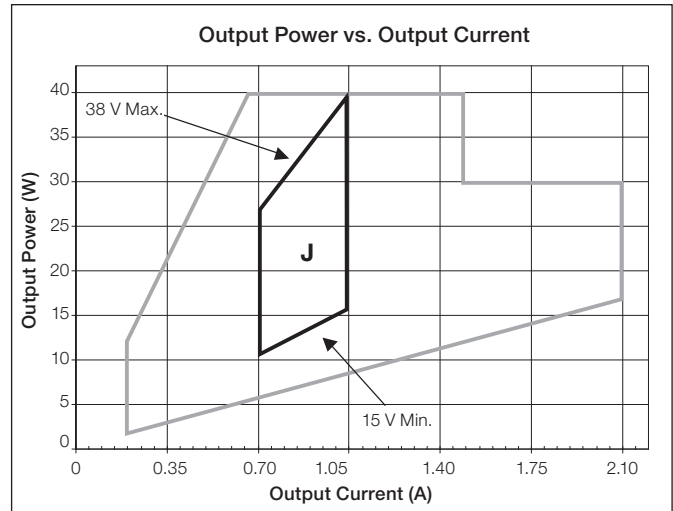
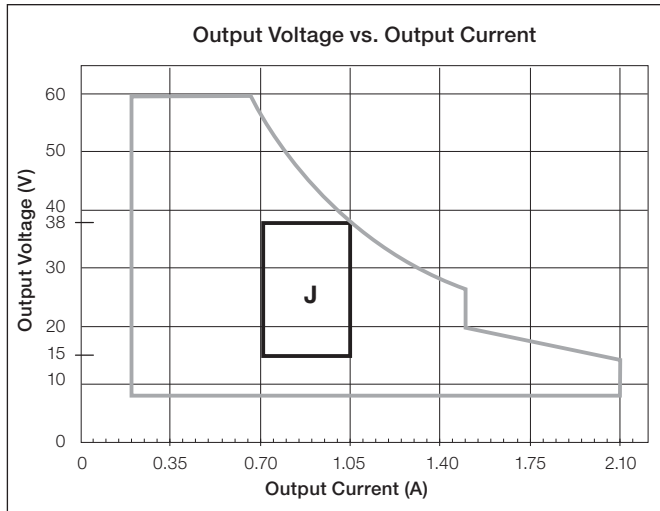

Typical Performance Specifications:

Parameter	Value	Test Conditions
Input Current	390 mA	$t_a = 25\text{ °C}$,
Power Factor	0.99	1.05 A 40 W load,
THD	7%	Maximum Light Output,
Driver Efficiency	84%	K case
		120 V \sim without a dimmer

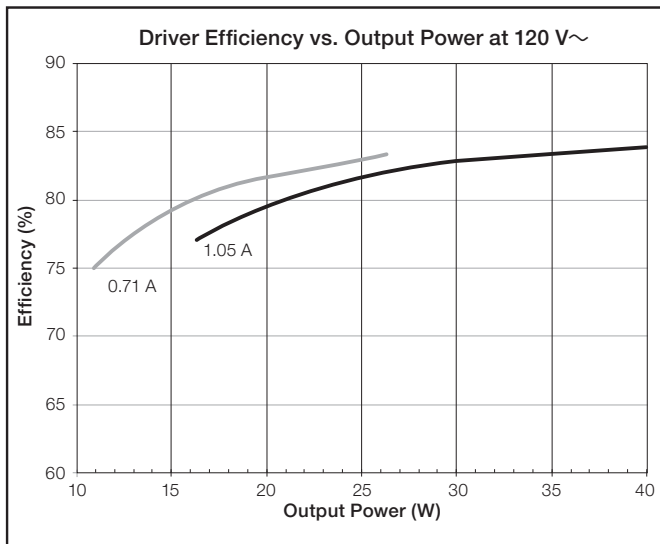

Job Name:	Model Numbers:
Job Number:	

“K” Output Range, Current Driver Models

Driver Type	Output Dimming Method	Output Voltage	Output Current	Output Power	Standards Recognition	UL® Listed Option (KL case)
Constant-Current Driver (Class 2)	Pulse Width Modulation (PWM)	8–20 V PWM	1.06–1.50 A	9–30 W	 Type TL 80 °/74 °C - K-case Type TL 90 °/69 °C - M-case	Yes
	Constant-Current Reduction (CCR)	8–20 V=				

When using QwikFig™ technology, these models can be built from the following bulk units:

K-case - LTEA4U1UKx-2RBLK*; M-case - LTEA4U1UMN-2CBLK

* x = studded (S) or non-studded (N)

Current Driver Operation Range:

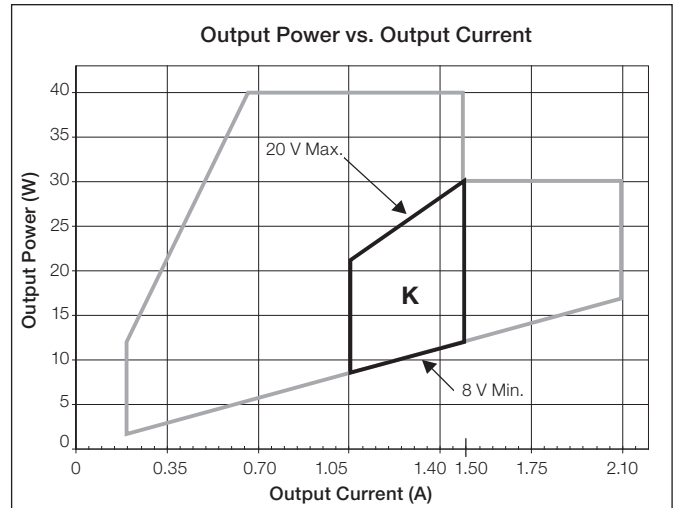
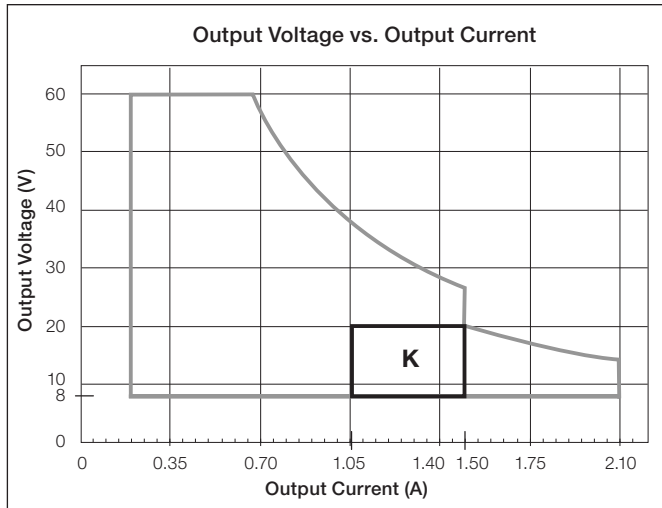

Typical Performance Specifications:

Parameter	Value	Test Conditions
Input Current	280 mA	$t_a = 25\text{ °C}$,
Power Factor	0.99	1.50 A 30 W load,
THD	12%	Maximum Light Output,
Driver Efficiency	79%	K case
		120 V~ without a dimmer

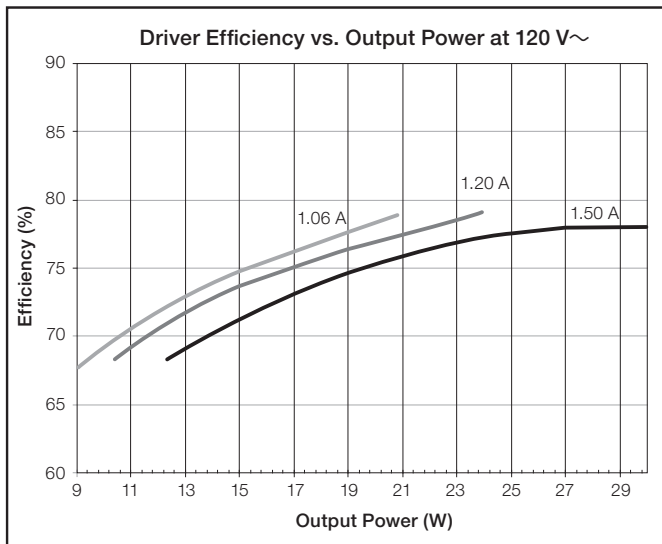

Job Name:	Model Numbers:
Job Number:	

“L” Output Range, Current Driver Models

Driver Type	Output Dimming Method	Output Voltage	Output Current	Output Power	Standards Recognition	UL® Listed Option (KL case)
Constant-Current Driver (Class 2)	Pulse Width Modulation (PWM)	15–38 V PWM	1.06–1.50 A	16–40 W	 Type TL 82 °/68 °C - K-case Type TL 86 °/78 °C - M-case	Yes
	Constant-Current Reduction (CCR)	15–38 V=				

When using QwikFig™ technology, these models can be built from the following bulk units:

K-case - LTEA4U1UKx-2SBLK*; M-case - LTEA4U1UMN-2BBLK

* x = studded (S) or non-studded (N)

Current Driver Operation Range:

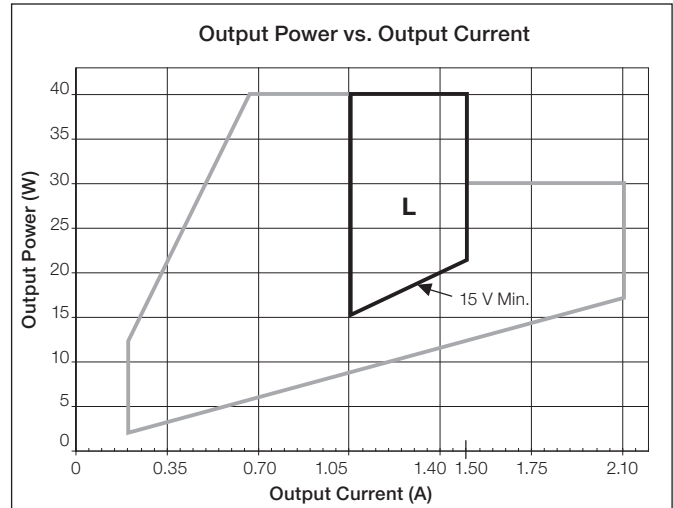
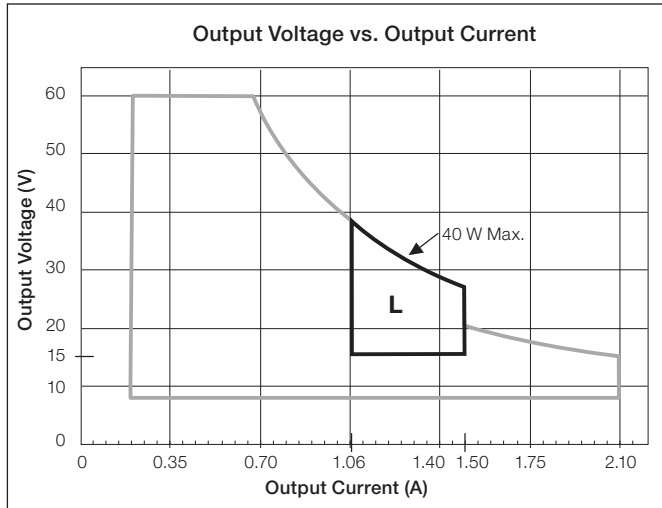

Typical Performance Specifications:

Parameter	Value	Test Conditions
Input Current	410 mA	$t_a = 25\text{ °C}$,
Power Factor	0.99	1.50 A 40 W load,
THD	9%	Maximum Light Output,
Driver Efficiency	82%	K case
		120 V~ without a dimmer

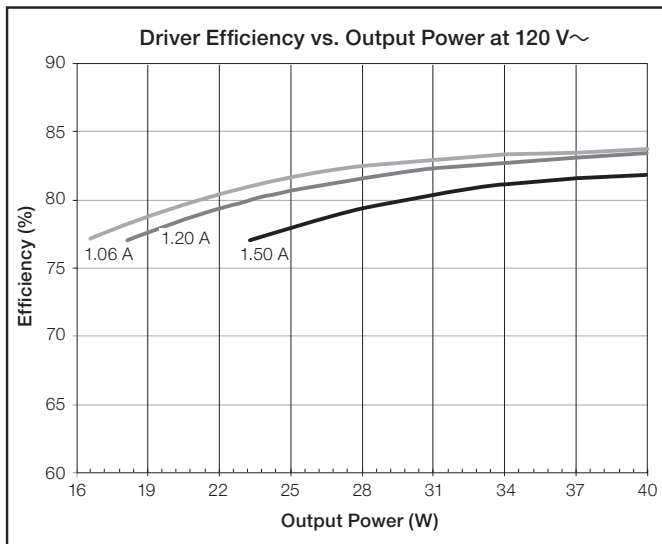

Job Name:	Model Numbers:
Job Number:	

“M” Output Range, Current Driver Models

Driver Type	Output Dimming Method	Output Voltage	Output Current	Output Power	Standards Recognition	UL® Listed Option (KL case)
Constant-Current Driver (Class 2)	Pulse Width Modulation (PWM)	8–19.9 V PWM	1.51–2.10 A	12–30 W	 Type TL 87 °/72 °C - K-case Type TL 90 °/73 °C - M-case	Yes
	Constant-Current Reduction (CCR)	8–19.9 V==				

When using QwikFig™ technology, these models can be built from the following bulk units:

K-case - LTEA4U1UKx-2ABLK*; M-case - LTEA4U1UMN-2ABLK

* x = studded (S) or non-studded (N)

Current Driver Operation Range:

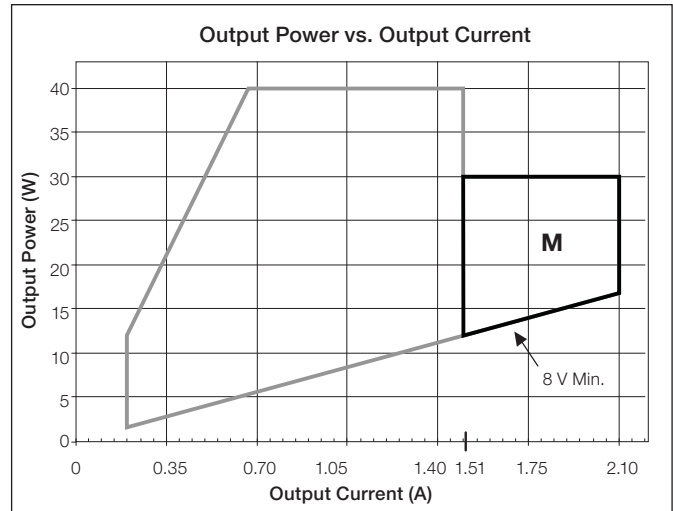
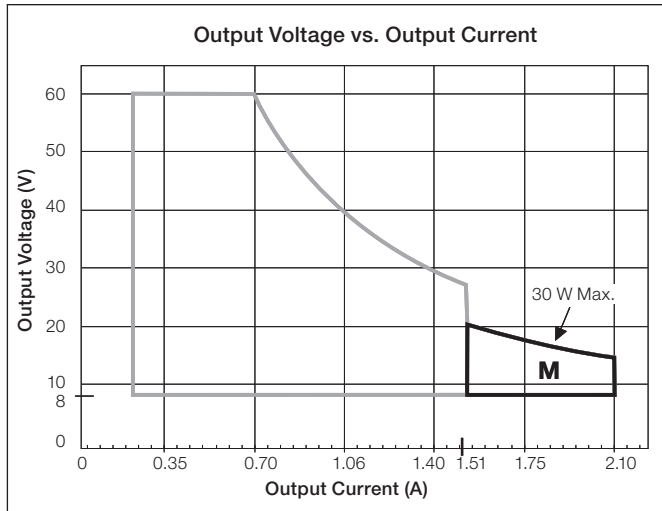

Typical Performance Specifications:

Parameter	Value	Test Conditions
Input Current	310 mA	t _a = 25 °C, 2.10 A 30 W load, Maximum Light Output, K case 120 V~ without a dimmer
Power Factor	0.99	
THD	14%	
Driver Efficiency	76%	

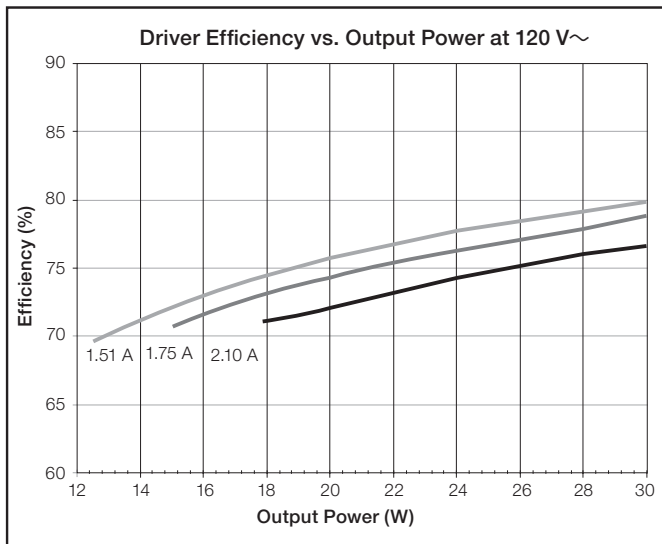

Job Name:	Model Numbers:
Job Number:	

“Y” Output Range, Current Driver Models

Driver Type	Output Dimming Method	Output Voltage	Output Current	Output Power	Standards Recognition	UL® Listed Option (KL case)
Constant-Current Driver (Isolated, Non-Class 2)	Pulse Width Modulation (PWM)	30–60 V PWM	0.20–0.50 A	6–30 W	 Type TL 80 °/72 °C - K-case Type TL 89 °/74 °C - M-case	No
	Constant-Current Reduction (CCR)	30–60 V=				

When using QwikFig™ technology, these models can be built from the following bulk units:

K-case - LTEA4U1UKx-1ABLK*; M-case - LTEA4U1UMN-1ABLK

* x = studded (S) or non-studded (N)

Current Driver Operation Range:

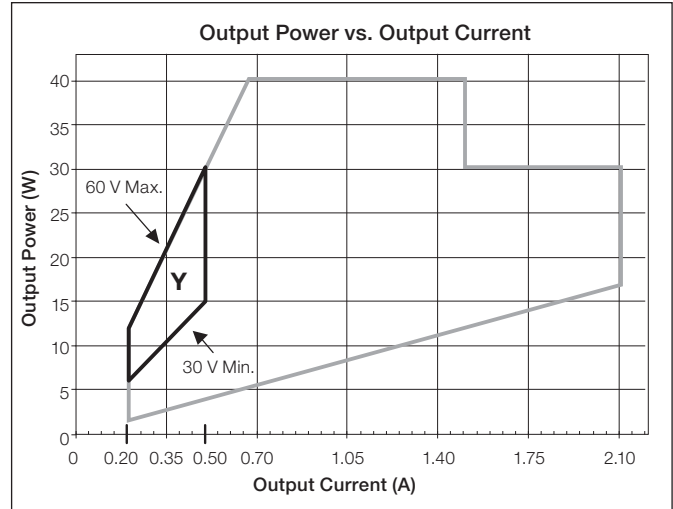
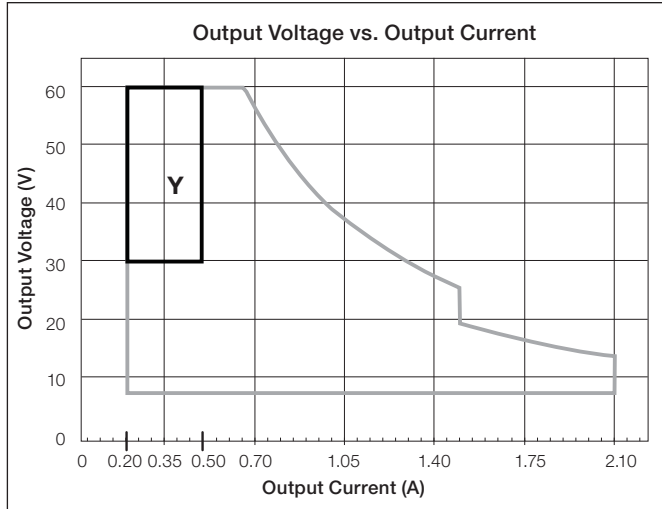

Typical Performance Specifications:

Parameter	Value	Test Conditions
Input Current	290 mA	t _a = 25 °C, 0.50 A 30 W load, Maximum Light Output, K case 120 V~ without a dimmer
Power Factor	0.99	
THD	11%	
Driver Efficiency	84%	

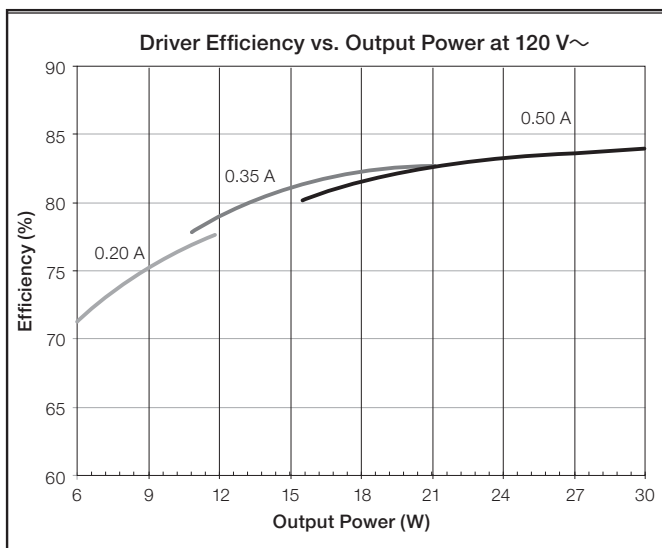

Job Name:	Model Numbers:
Job Number:	

“Z” Output Range, Current Driver Models

Driver Type	Output Dimming Method	Output Voltage	Output Current	Output Power	Standards Recognition	UL® Listed Option (KL case)
Constant-Current Driver (Isolated, Non-Class 2)	Pulse Width Modulation (PWM)	30–60 V PWM	0.51–1.00 A	16–40 W	 Type TL 80 °/72 °C - K-case Type TL 89 °/74 °C - M-case	No
	Constant-Current Reduction (CCR)	30–60 V=				

When using QwikFig™ technology, these models can be built from the following bulk units:

K-case - LTEA4U1UKx-1ABLK*; M-case - LTEA4U1UMN-1ABLK

* x = studded (S) or non-studded (N)

Current Driver Operation Range:

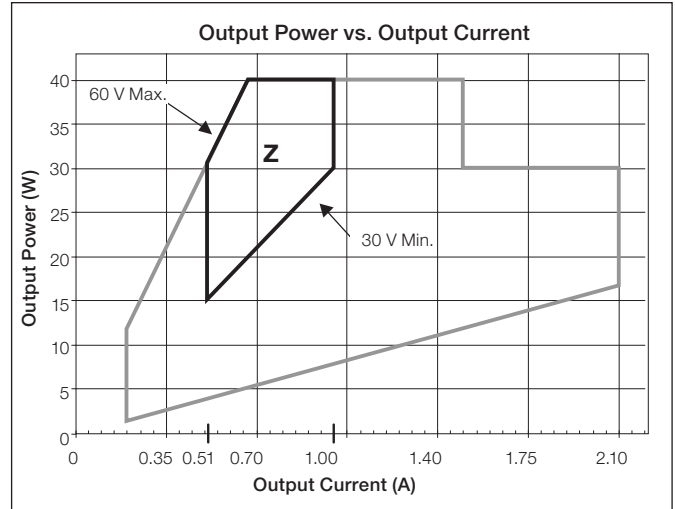
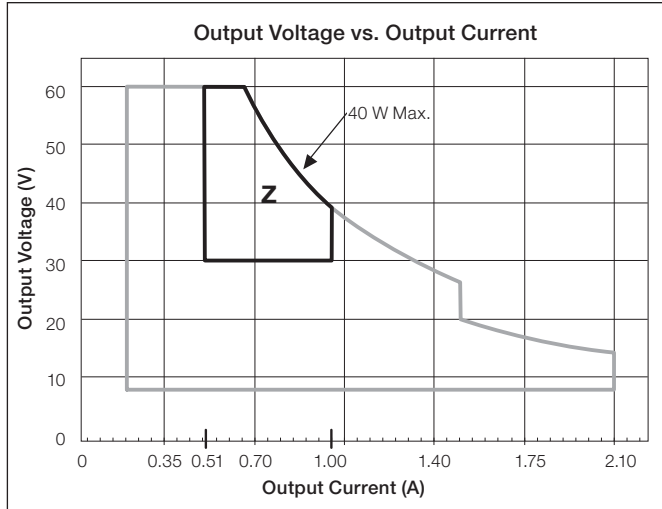

Typical Performance Specifications:

Parameter	Value	Test Conditions
Input Current	410 mA	t _a = 25 °C, 1.00 A 40 W load, Maximum Light Output, K case 120 V~ without a dimmer
Power Factor	0.99	
THD	8%	
Driver Efficiency	83%	

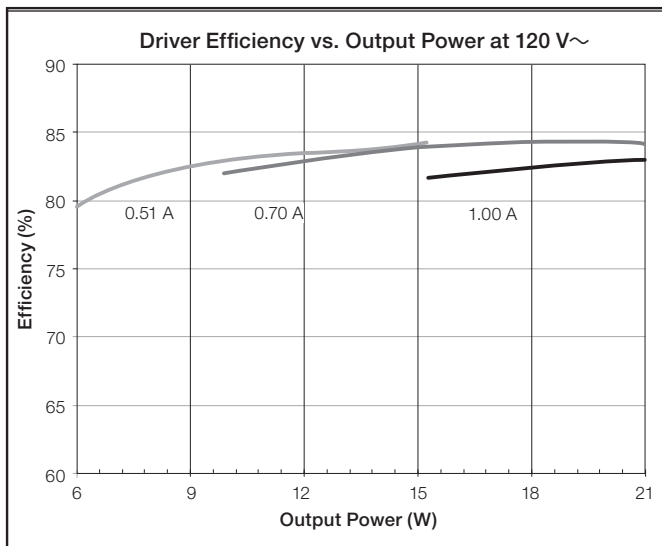

Job Name:	Model Numbers:
Job Number:	

K Case: Case Dimensions

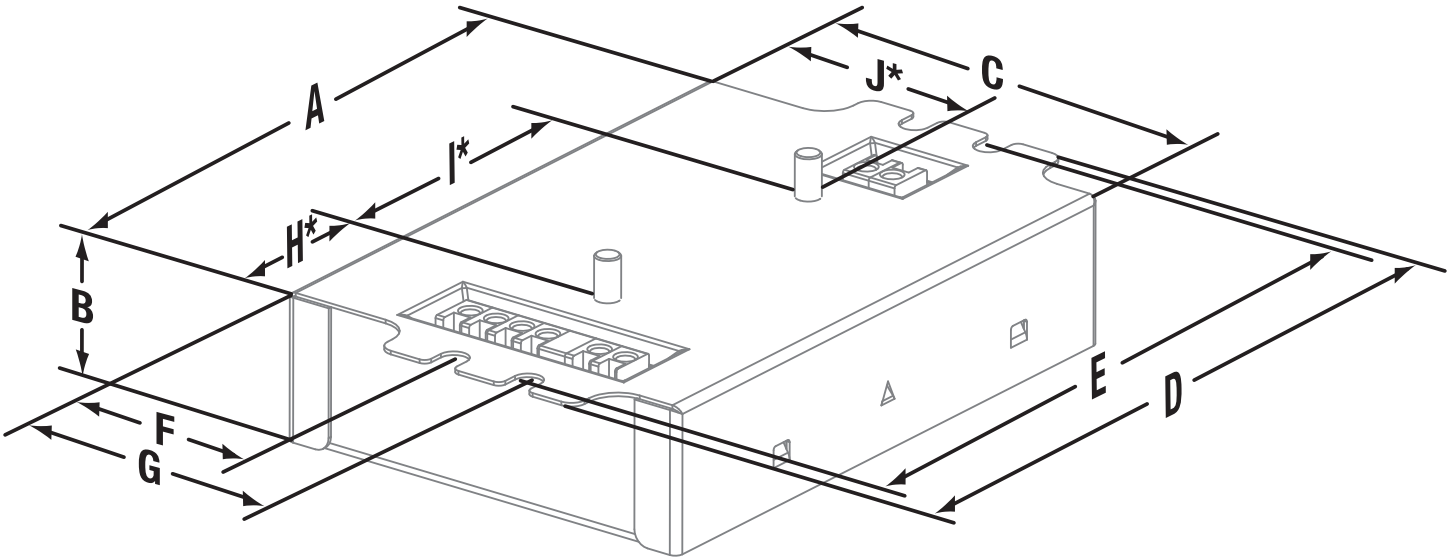

K Case: Connector Location Dimensions

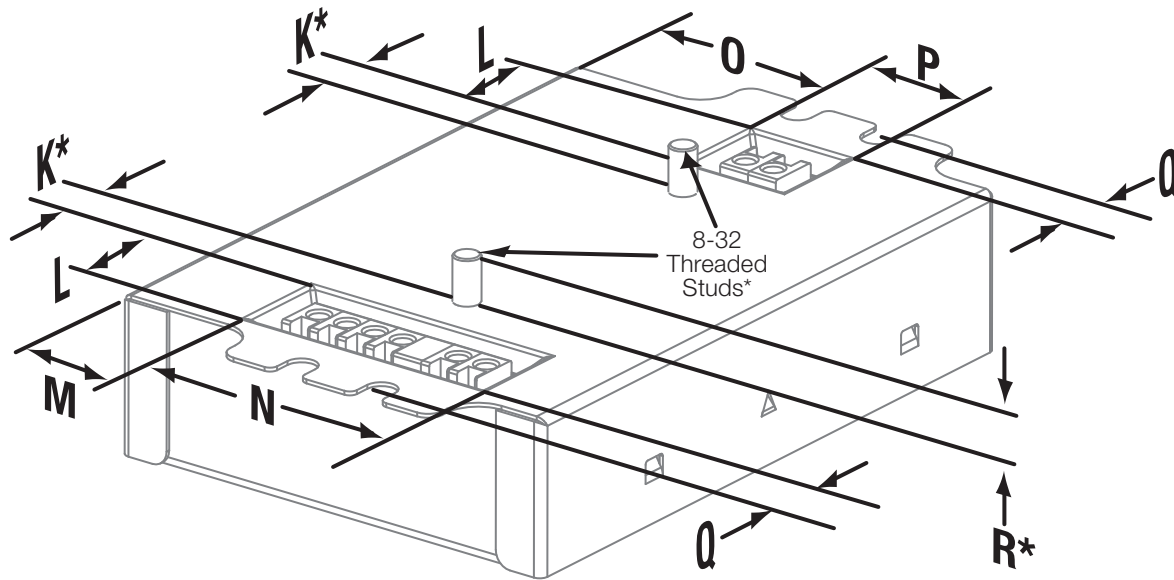

A	4.20 in (107 mm)	F	1.42 in (36 mm)	K*	0.33 in (8.3 mm)	P	0.74 in (19 mm)
B	1.00 in (25 mm)	G	1.99 in (51 mm)	L	0.65 in (16.5 mm)	Q	0.32 in (8 mm)
C	3.00 in (76 mm)	H*	1.11 in (28 mm)	M	0.75 in (19 mm)	R*	0.29 in (7 mm)
D	4.90 in (124 mm)	I*	2.00 in (51 mm)	N	1.73 in (44 mm)		
E	4.60 in (117 mm) (mounting center)	J*	1.60 in (41 mm)	O	1.33 in (34 mm)		

* Applies to studded K case only.

Job Name:	Model Numbers:
Job Number:	

K Case: Side Entry Connector Location Dimensions (Non-Studded)

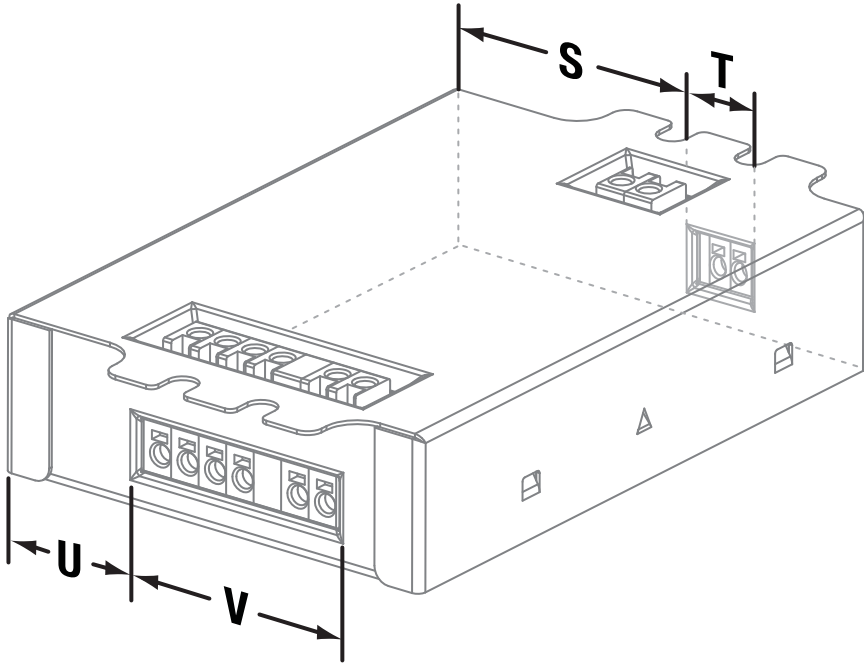

- S 1.38 in (35 mm)
- T 0.64 in (16 mm)
- U 0.88 in (22 mm)
- V 1.53 in (39 mm)

M Case: Case Dimensions

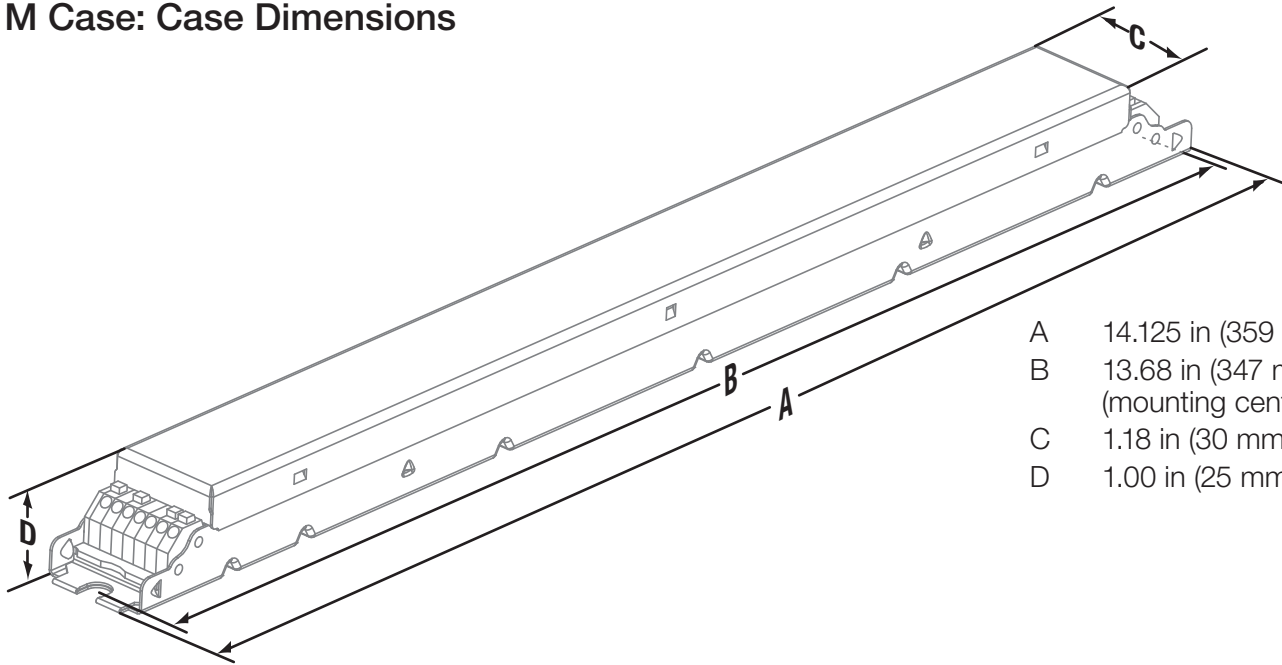

- A 14.125 in (359 mm)
- B 13.68 in (347 mm)
(mounting center)
- C 1.18 in (30 mm)
- D 1.00 in (25 mm)

Job Name:	Model Numbers:
Job Number:	

KL Case: Case Dimensions

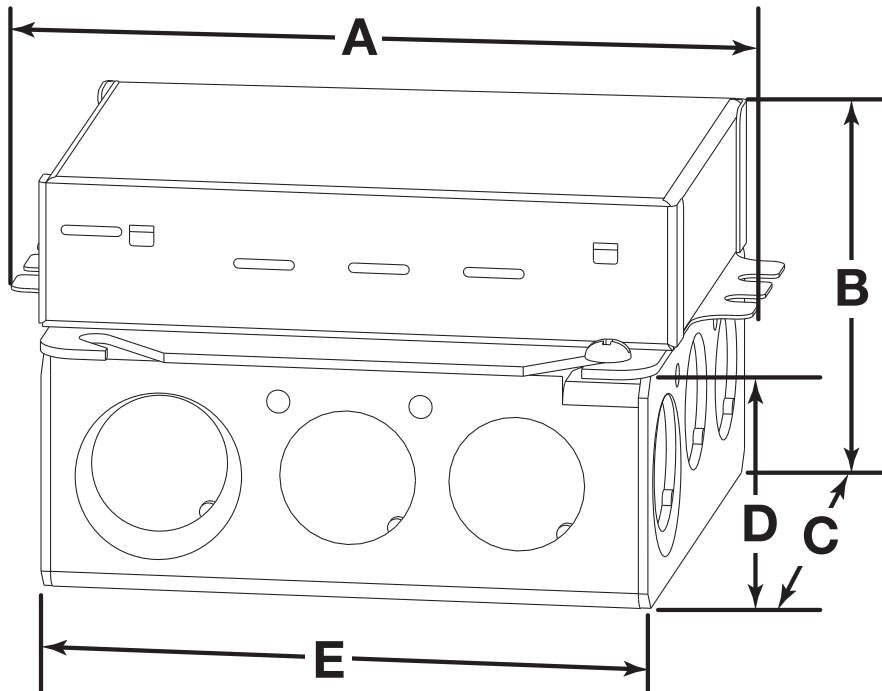

A	4.89 in (124 mm)
B	2.62 in (66 mm)
C	4.00 in (102 mm)
D	1.62 in (41 mm)
E	4.00 in (102 mm)

KL case includes a 4 in (102 mm) square junction box which complies with NEMA® OS 1-2008 Figure 112.

Knockouts

- Sides
 - 8 locations: 0.5 in (13 mm)
 - 4 locations: 0.5/0.75 in (13/19 mm)
- Bottom
 - 2 locations: 0.5 in (13 mm)
 - 2 locations: 0.5/0.75 in (13/19 mm)

Driver Wiring and Mounting

- Driver is grounded by the green ground wire connection on the enclosure or by the ground lug terminal in the junction box
- Driver and junction box must be grounded in accordance with local and national electrical codes
- All wire connections must be made in the junction box to maintain UL® listing
- 4 in (102 mm) square junction box is 1.5 in (38 mm) deep with 22.0 in³ (360.5 cm³) capacity and complies with NEMA® OS 1-2008 Figure 112
- Driver is pre-wired with 6 in (152 mm), 18 AWG (0.75 mm²) solid copper leads in all terminal blocks

Job Name:

Model Numbers:

Job Number:

Wiring

Controls Requiring Neutral

Note: Colors shown correspond to terminals on driver.

Wiring Diagram

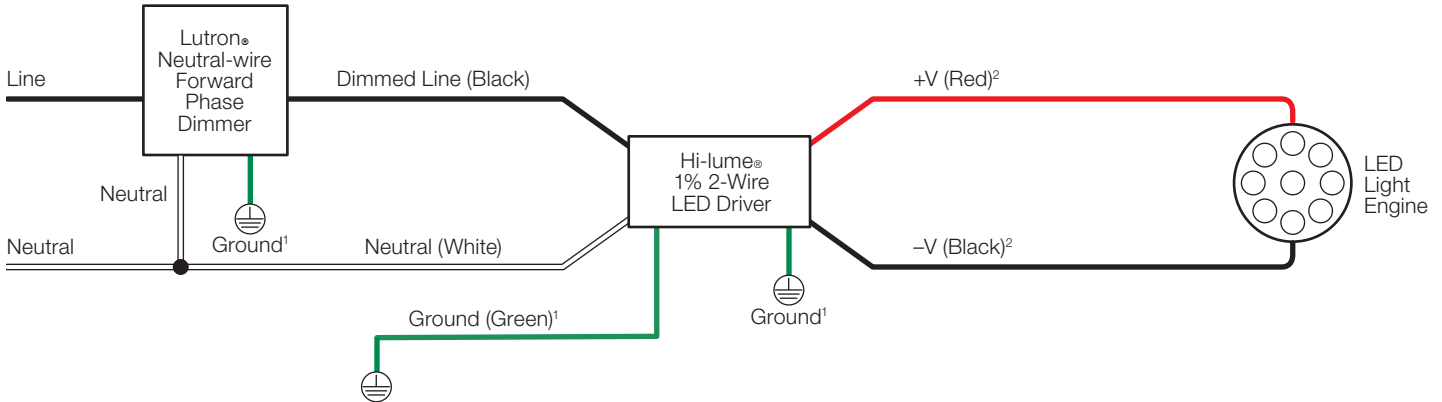

¹Ground wire connection available on K case models only. Fixture and driver case must be grounded in accordance with local and national electrical codes.

²For maximum driver-to-LED light engine wire length, see charts in **Driver Leads** section at the end of the document.

Compatible Controls: Lutron® Neutral-wire Dimmers

Guaranteed performance specifications with the controls listed in the chart below.

For assistance selecting controls, contact our LED Center of Excellence at 1.877.346.5338 or LEDs@lutron.com

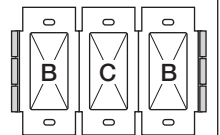
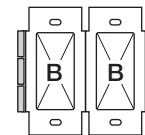

Product	Part Number	Low-End Setting/Load-Type Setting ¹	Drivers per Control		
			A: Not Ganged	B: End of Gang	C: Middle of Gang
Maestro Wireless® 600 W dimmer	MRF2-6ND-120-	Trim low-end per APM App Note (Lutron® P/N 048370)	1–8	1–8	1–8
Caséta® Wireless Pro 1000 W dimmer	PD-10NXD-	Trim low-end per instructions at www.casetawireless.com/lowend	1–13	1–13	1–13
GRAFIK T™ C•L® dimmer	GT-250M-GTJ-250M-	Set low-end trim per dimmer installation instructions	1–10	1–10	1–10
HomeWorks® QS adaptive dimmer	HQRD-6NA-	“Hi-lume® 1% 2-Wire LTE LED” ²	1–8	1–8	1–8
HomeWorks® QS 600 W dimmer	HQRD-6ND-	“Hi-lume® 1% 2-Wire LTE LED” ²	1–8	1–8	1–8
HomeWorks® QS 1000 W dimmer	HQRD-10ND-	“Hi-lume® 1% 2-Wire LTE LED” ²	1–13	1–13	1–13
RadioRA® 2 adaptive dimmer	RRD-6NA-	“Hi-lume® 1% 2-Wire LTE LED” ²	1–8	1–8	1–8
RadioRA® 2 1000 W dimmer	RRD-10ND-	Set Device type to “INC/MLV Neutral Dimmer”; Set High-End Trim to 99%; Set Low-End Trim to 35%	1–13	1–13	1–13

¹Setting the low-end trim and load type is necessary to ensure optimal performance and 1% dimming capability.

Note: For information about Legacy Product use in existing control application, contact LEDs@lutron.com

²Also listed as “LED Lutron® A-Series 2-Wire” or “Hi-lume® A-Series LTE LED Driver 2-Wire” in previous software releases.

Job Name:	Model Numbers:
Job Number:	

Wiring (continued)

Controls Requiring Neutral (continued)

Note: Colors shown correspond to terminals on driver.

Wiring Diagram

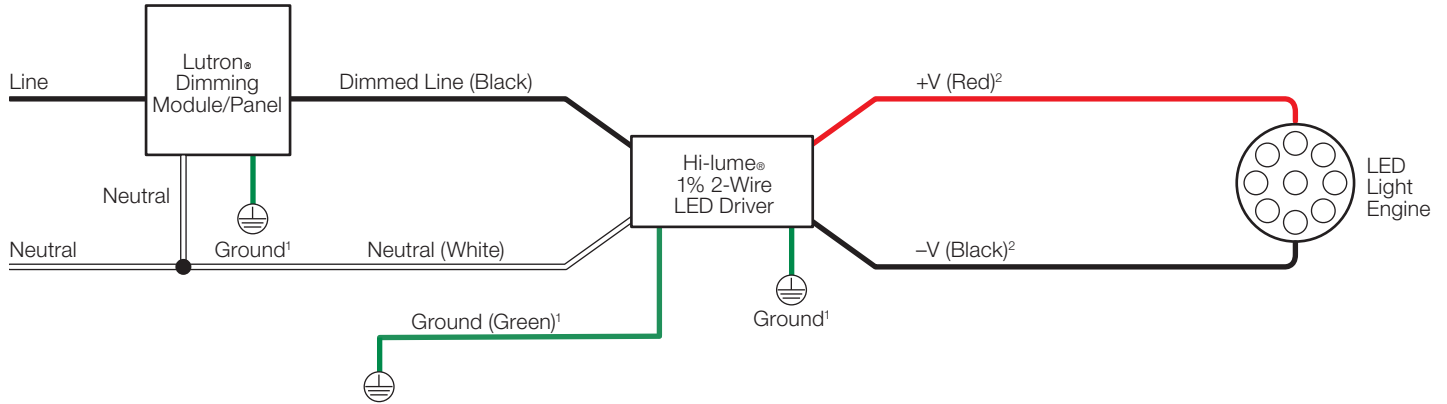

¹Ground wire connection available on K case models only. Fixture and driver case must be grounded in accordance with local and national electrical codes.

²For maximum driver-to-LED light engine wire length, see charts in **Driver Leads** section at the end of the document.

Compatible Controls: Lutron® Dimming Modules/Panels

Guaranteed performance specifications with the controls listed in the chart below.

For assistance selecting controls, contact our LED Center of Excellence at 1.877.346.5338 or LEDs@lutron.com

Product	Part Number	Drivers per Control	Low-End Setting/Load-Type Setting ¹
myRoom™ DIN power module	MQSE-4A1-D	1–6 (per output); 1 A maximum driver input current	“Hi-lume® 1% 2-Wire LTE LED” ²
HomeWorks® QS DIN power module	LQSE-4A1-D	1–6 (per output); 1 A maximum driver input current	“Hi-lume® 1% 2-Wire LTE LED” ²
HomeWorks® QS wallbox power module	HQRJ-WPM-6D-120	2–10 (per output); 26 total per module	“Hi-lume® 1% 2-Wire LTE LED” ²
HomeWorks® wallbox power module	HWI-WPM-6D-120	2–10 (per output); 26 total per module	Set load type to “GRX-FDBI” or “GRX-TVI”
GRAFIK Eye® QS control unit	QSGR-, QSGRJ-	2–10 (per output); 26 total per unit	Set load type to “Fluorescent Module”
GRAFIK Eye® 3000 control unit	GRX-3100-, GRX-3500-	2–10 (per output); 26 total per module	Set load type to “GRX-FDBI” or “GRX-TVI”
RPM-4U module (LCP, HomeWorks® QS, GRAFIK Systems™, Quantum®)	HW-RPM-4U-120, LP-RPM-4U-120	2–26 (per output); 26 total per module	“Hi-lume® 1% 2-Wire LTE LED” ²
			Set load type to “2-1”
RPM-4A module (LCP, HomeWorks® QS, GRAFIK Systems™, Quantum®)	HW-RPM-4A-120, LP-RPM-4A-120	1–13 (per output); 26 total per module	“Hi-lume® 1% 2-Wire LTE LED” ²
			Set load type to “2-1”
GP dimming panels	Various	1–26	Set load type to “2-1”

¹Setting the low-end trim and load type is necessary to ensure optimal performance and 1% dimming capability.

²Also listed as “LED Lutron® A-Series 2-Wire” or “Hi-lume® A-Series LTE LED Driver 2-Wire” in previous software releases.

Job Name:	Model Numbers:
Job Number:	

Wiring (continued)

Controls Not Requiring Neutral

Note: Colors shown correspond to terminals on driver.

Wiring Diagram

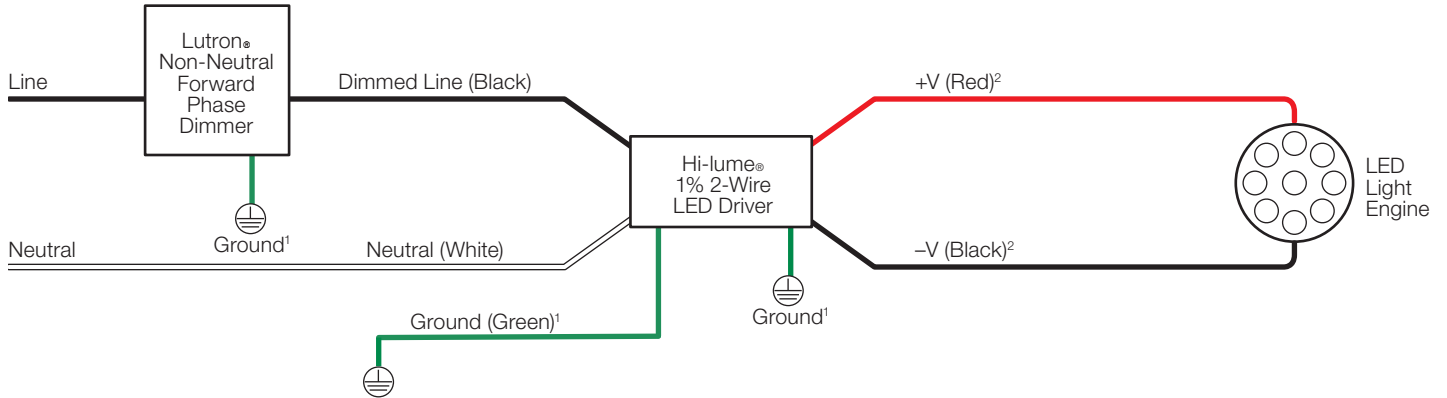

¹ Ground wire connection available on K case models only. Fixture and driver case must be grounded in accordance with local and national electrical codes.

²For maximum driver-to-LED light engine wire length, see charts in **Driver Leads** section at the end of the document.

Compatible Controls: Lutron® Non-Neutral Dimmers

Guaranteed performance specifications with the controls listed in the chart below.

For assistance selecting controls, contact our LED Center of Excellence at 1.877.346.5338 or LEDs@lutron.com

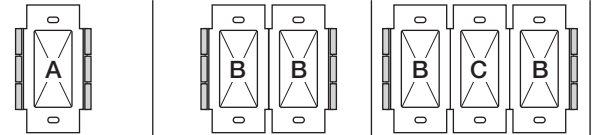

Product	Part Number	Low-End Setting/ Load-Type Setting*	Drivers per Control		
			A: Not Ganged	B: End of Gang	C: Middle of Gang
Ariadni® C•L® 250 W dimmer	AYCL-253P-	Set low-end trim dial to 1 o'clock. Adjust slightly if needed. See Figure 1 under 'Dimmer Range Adjustment' section in the Dimmer Installation Guide for how to adjust low-end trim	1-8	1-8	1-8
Diva® C•L® 250 W dimmer	DVCL-253P- DVSCCL-253P-	Set low-end trim dial to 10 o'clock. Adjust slightly if needed. See Figure 1 under 'Dimmer Range Adjustment' section in the Dimmer Installation Guide for how to adjust low-end trim	1-8	1-8	1-8
Nova T★® C•L® 250 W dimmer	NTCL-250-	Set low-end trim per dimmer installation instructions	1-10	1-10	1-10

* Setting the low-end trim and load type is necessary to ensure optimal performance and 1% dimming capability.

Note: For information about Legacy Product use in existing control application, contact LEDs@lutron.com

Job Name:	Model Numbers:
Job Number:	

Terminal Wiring Gauges

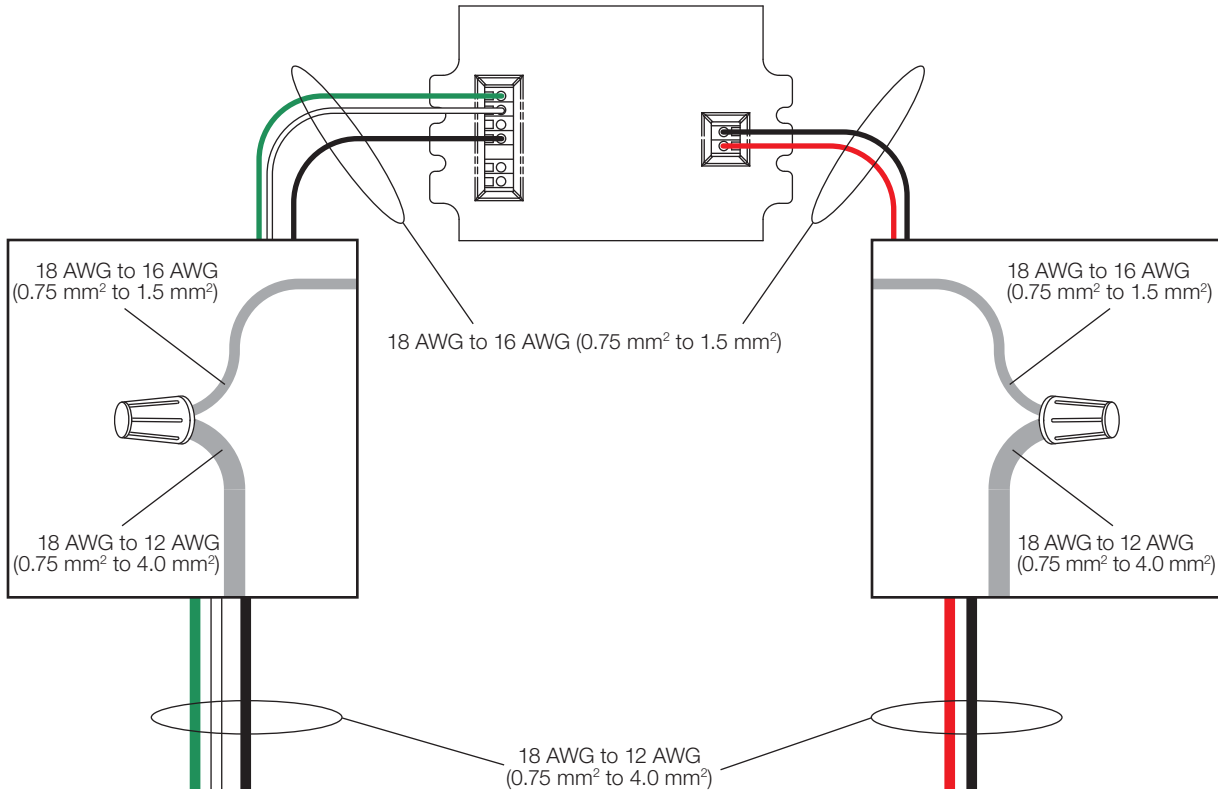

Wiring Diagram for 2-Wire Control

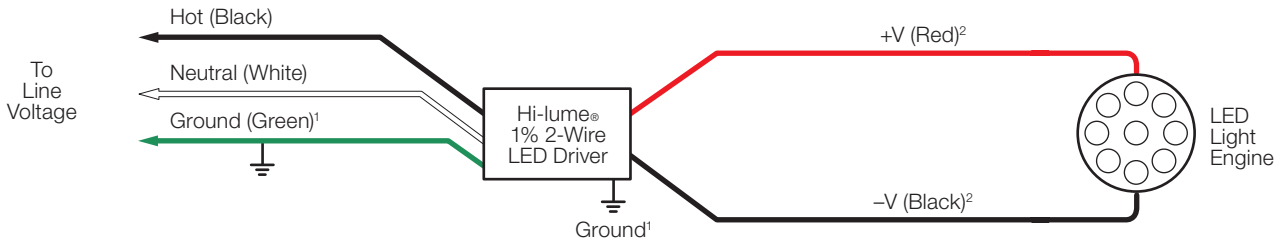

¹ Fixture and driver case must be grounded in accordance with local and national electrical codes; ground connection to driver case can be accomplished through ground terminal, and/or grounding the case.

² For maximum driver-to-LED light engine wire length, see charts in the **Driver Wiring and Mounting** section.

Note: Colors shown correspond to terminal blocks on driver.

Job Name:	Model Numbers:
Job Number:	

ELECTRICIANS AND CONTRACTORS

Driver Leads

Maximum driver-to-LED light engine wire length for
Constant-Current Drivers:

Wire Gauge	Maximum Lead Length		
	200 mA to 700 mA	710 mA to 1.50 A	1.51 A to 2.10 A
18 AWG (0.75 mm ²)	30 ft (9 m)	15 ft (4.5 m)	10 ft (3 m)
16 AWG (1.5 mm ²)	35 ft (10.5 m)	25 ft (7.5 m)	15 ft (4.5 m)
14 AWG (2.5 mm ²)	50 ft (15 m)	40 ft (12 m)	25 ft (7.5 m)
12 AWG (4.0 mm ²)	100 ft (30 m)	60 ft (18 m)	40 ft (12 m)

Maximum driver-to-LED light engine wire length for
Constant-Voltage Drivers:

Wire Gauge	Maximum Lead Length		
	10 to 20 V ⁻⁻⁻	20.5 to 40 V ⁻⁻⁻	40.5 to 60 V ⁻⁻⁻
18 AWG (0.75 mm ²)	10 ft (3 m)	15 ft (4.5 m)	30 ft (9 m)
16 AWG (1.5 mm ²)	15 ft (4.5 m)	25 ft (7.5 m)	50 ft (15 m)
14 AWG (2.5 mm ²)	25 ft (7.5 m)	40 ft (12 m)	75 ft (22.5 m)
12 AWG (4.0 mm ²)	40 ft (12 m)	60 ft (18 m)	100 ft (30 m)

* Terminal blocks on the drivers accept only solid 18 AWG to 16 AWG (0.75 mm² to 1.5 mm²) wire. To use wire gauges larger than the terminal blocks' rated gauge of 18 AWG to 16 AWG (0.75 mm² to 1.5 mm²), refer to the **Terminal Wiring Gauges** diagram on the previous page. Connect up to 3 ft (0.9 m) of 18 AWG to 16 AWG (0.75 mm² to 1.5 mm²) wire to the LED driver terminal blocks, then connect 14 AWG to 12 AWG (2.5 mm² to 4.0 mm²) up to the length allowed in the above table.

Wiring and Grounding

Driver and lighting fixture must be grounded.
Drivers must be installed per national and local electrical codes.

LED Load Replacement

For Class 2 rated drivers, the LED load can be changed while the driver is installed and powered.

Maximum Driver Operating Temperature

Driver case temperature (t_c) must not exceed UL® conditions of acceptability in end product.

For 50,000 hour lifetime, driver case temperature (t_c) must not exceed 65 °C.

Job Name:	Model Numbers:
Job Number:	

FACILITIES MANAGERS

EMC Information

This device complies with part 15 of the FCC Rules. Operation is subject to the following two conditions: (1) This device may not cause interference, and (2) this device must accept any interference, including interference that may cause undesired operation.

FOR UL® RECOGNIZED MODELS ONLY:

NOTE: This equipment has been tested and found to comply with the limits for a Class A digital device, pursuant to part 15 of the FCC rules. These limits are designed to provide reasonable protection against harmful interference when the equipment is operated in a commercial environment. This equipment generates, uses and can radiate radio frequency energy and, if not installed and used in accordance with the instruction manual, may cause harmful interference to radio communications. Operation of this equipment in a residential area is likely to cause harmful interference in which case the user will be required to correct the interference at his own expense.

FOR UL® LISTED MODELS ONLY:

NOTE: This equipment has been tested and found to comply with the limits for a Class B digital device, pursuant to part 15 of the FCC Rules. These limits are designed to provide reasonable protection against harmful interference in a residential installation. This equipment generates, uses and can radiate radio frequency energy and, if not installed and used in accordance with the instructions, may cause harmful interference to radio communications. However, there is no guarantee that interference will not occur in a particular installation. If this equipment does cause harmful interference to radio or television reception, which can be determined by turning the equipment off and on, the user is encouraged to try to correct the interference by one or more of the following measures:

- Reorient or relocate the receiving antenna.
- Increase the separation between the equipment and receiver.
- Connect the equipment into an outlet on a circuit different from that to which the receiver is connected.
- Consult the dealer or an experienced radio/TV technician for help.

Job Name:	Model Numbers:
Job Number:	

FACILITIES MANAGERS

SERVICE

Warranty

For warranty information, please visit www.lutron.com/driverwarranty

Replacement Parts

When ordering Lutron® replacement parts please provide the full model number. Consult Lutron® Customer Assistance at 1.844.LUTRON1 if you have any questions.

Further Information

For further information, please visit us at www.lutron.com/hilume1led or contact our LED Control Center of Excellence at 1.877.346.5338 or LEDs@lutron.com

Job Name:	Model Numbers:
Job Number:	