

100 Linear Recessed

PLASTER TRIM

PATTERN CORNER (P)

WG-100LDL-RPT-P

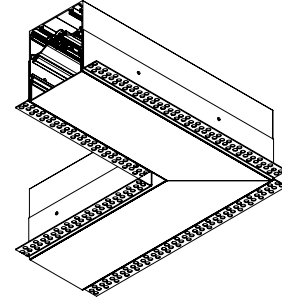
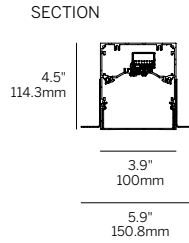
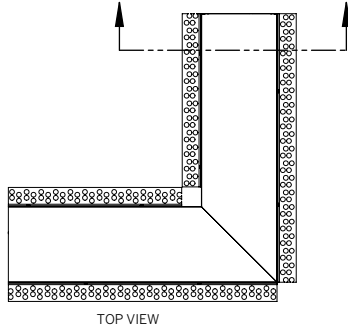

Mitered + Welded Housing
Mitered + Butted Lens

Minimum Angle 60°
Maximum Angle 180°

PLANE TO PLANE INSIDE CORNER (PPI)

WG-100LDL-RPT-PPI

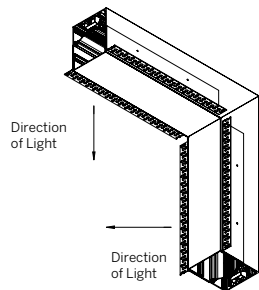
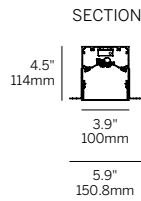
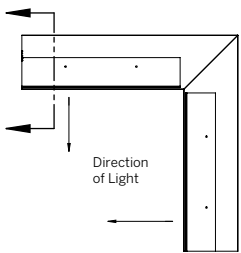

Mitered + Welded Housing
Mitered + Butted Lens

PLANE TO PLANE OUTSIDE CORNER (PPO)

WG-100LDL-RPT-PPO

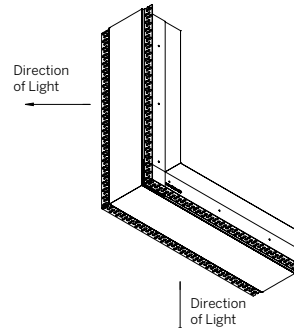
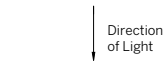
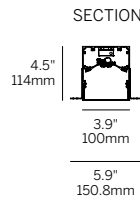

Mitered + Welded Housing
Mitered + Butted Lens

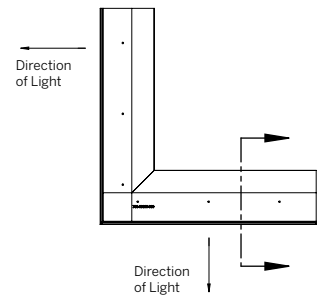

100 Linear Recessed

PLASTER TRIM

PATTERN CORNER (P)

WG-100LDL-[RBT / RGTX]-P

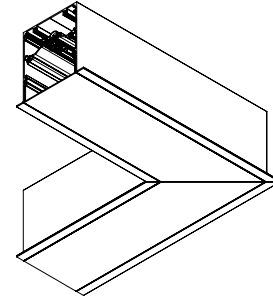
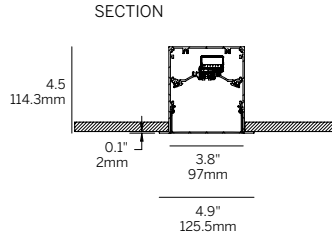
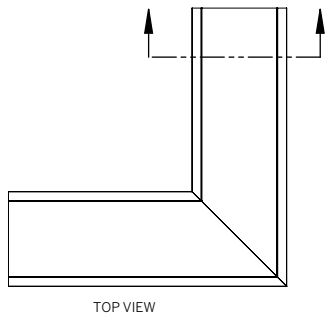

Mitered + Welded Housing
Mitered + Butted Lens

Minimum Angle 48°
Maximum Angle 180°

PLANE TO PLANE INSIDE CORNER (PPI)

WG-100LDL-RBT-PPI

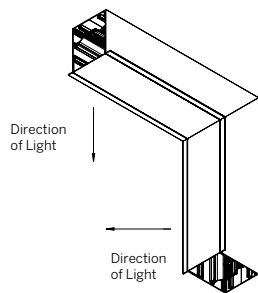
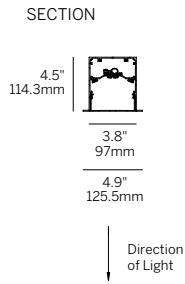
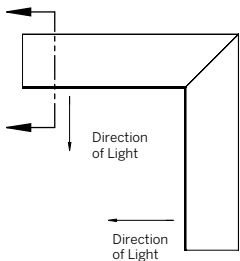

Mitered + Welded Housing
Mitered + Butted Lens

PLANE TO PLANE OUTSIDE CORNER (PPO)

WG-100LDL-RBT-PPO

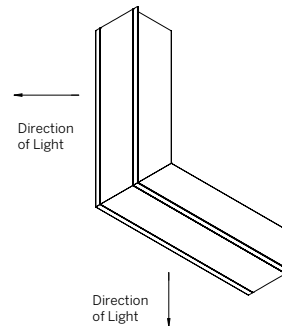
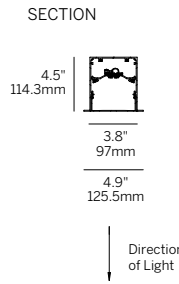

Mitered + Welded Housing
Mitered + Butted Lens

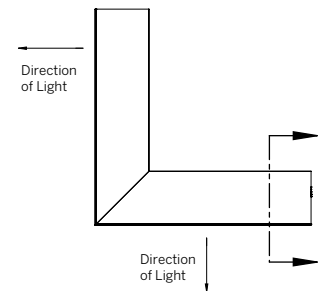

CORNER + STRAIGHT RUN CONNECTIONS

Recessed Plaster Trim

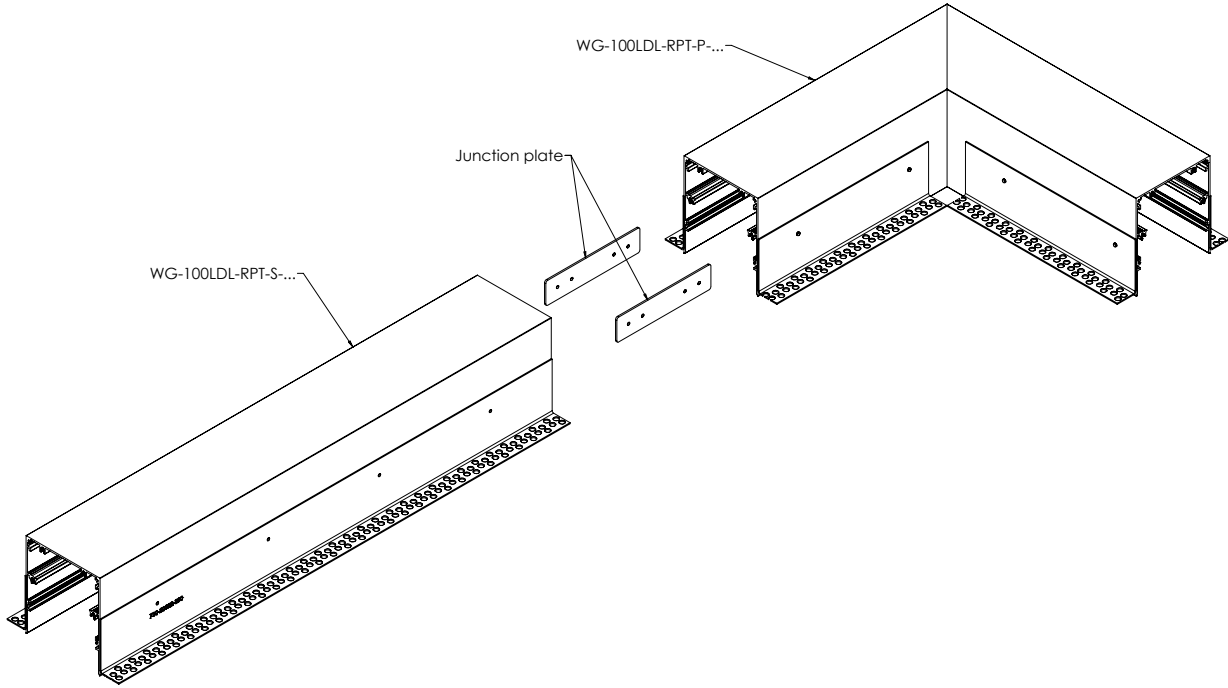

CORNER + STRAIGHT RUN CONNECTIONS

Recessed Bezel Trim / Recessed Grid Trim

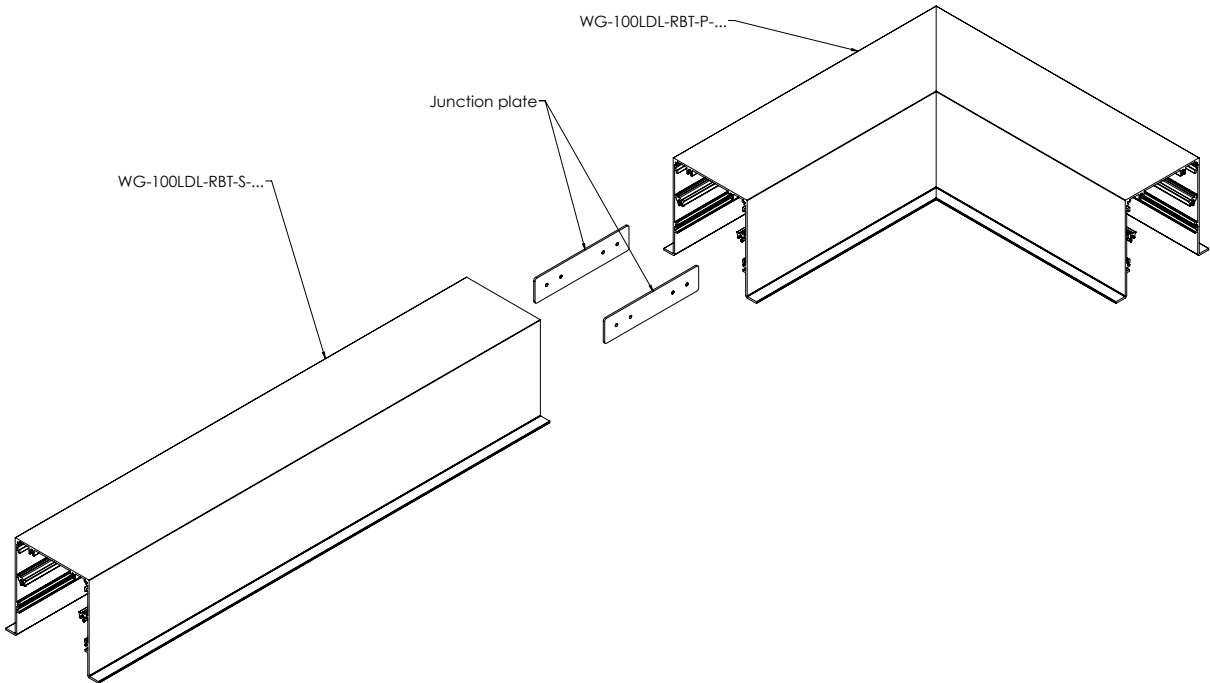

100 Linear Recessed

PROFILE DIMENSIONS

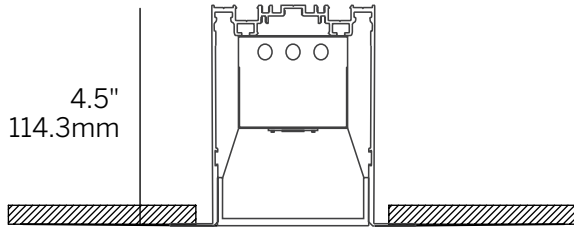

3.8"
97mm

5.9"
150.8mm

Recessed Plaster Trim
(RPT)

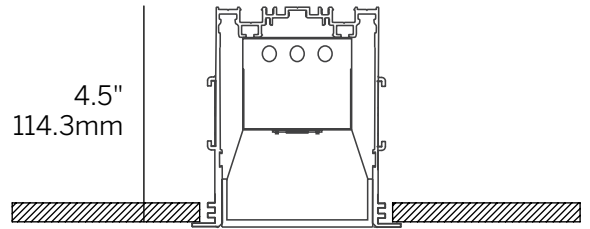

4.5"
114.3mm

3.8"
97mm

4.9"
125.5mm

Recessed Bezel Trim
(RBT)

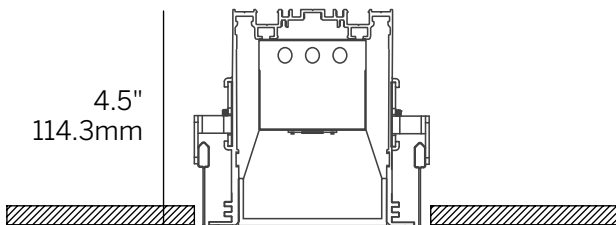

4.5"
114.3mm

3.8"
97mm

5.1"
128mm

Recessed Grid Trim
9/16 (RGT9) / 15/16 (RGT15)

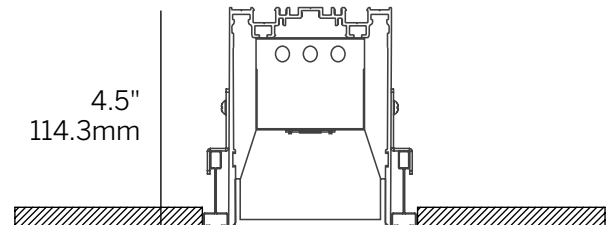

4.5"
114.3mm

3.8"
97mm

5.1"
128mm

Recessed Trim for Slot Grid
(RGTS)