

Constant Current drivers

Wiring Key Points

1. This product shall be installed by a qualified electrician.
2. Make sure the main power supply to the driver is turned off when wiring either the LEDs or driver.
3. LEDs shall be wired in series as shown in wiring diagram. CAUTION: parallel wiring will damage LEDs.
4. Wire shall be 18 awg stranded minimum. Large gauge wire shall be used to limit voltage drop in order to maintain the proper operating voltage. Take every precaution to avoid interference from other electrical circuits and equipment.
5. Dimming circuits are more sensitive to voltage drop and electrical interference from other electrical sources.
6. Isolating LED wiring by dedicated circuit for each control zone is recommended.
7. Contractor shall verify the fixture quantities connected to the driver are compatible with the driver's specifications prior to energizing the circuit.
8. All Class II power cable remote wiring and driver enclosures by others.

LED's can be permanently damaged if these points are not followed

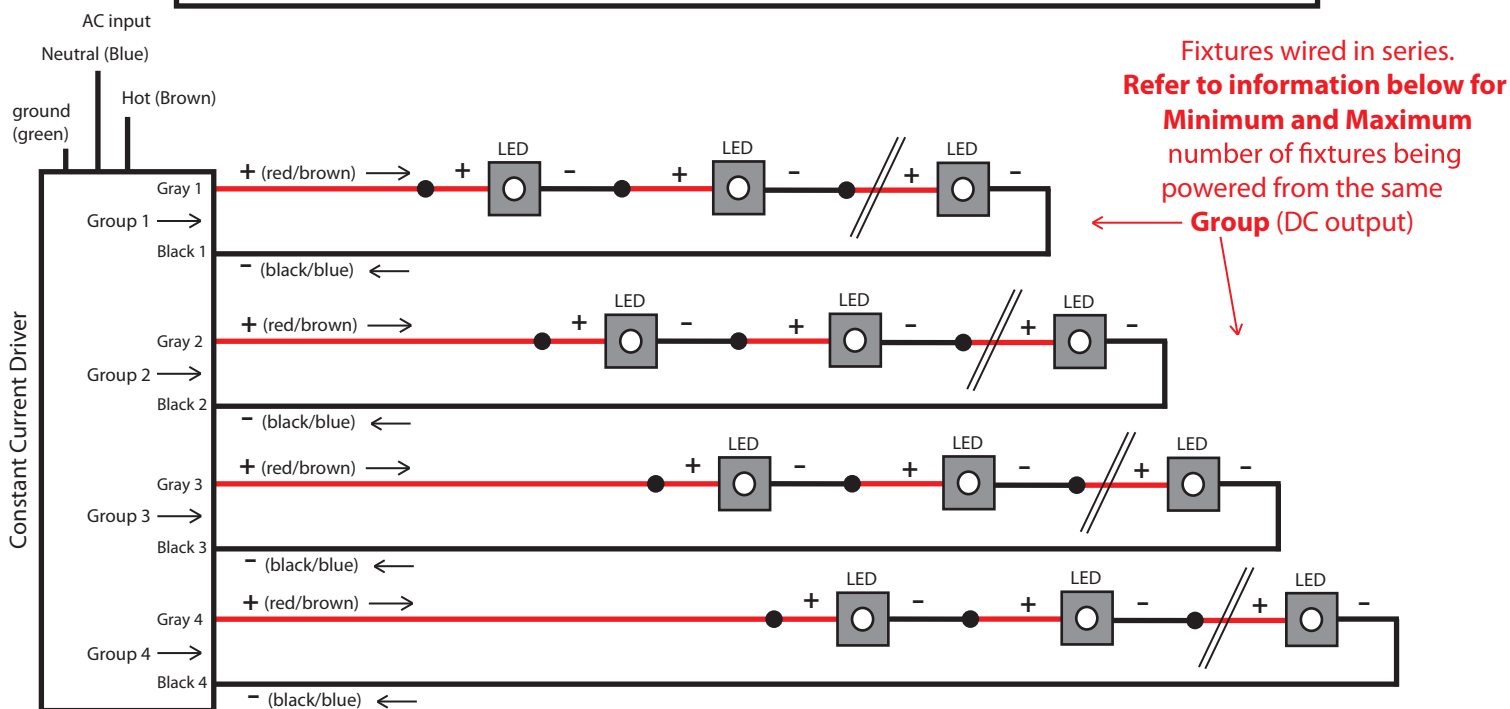

Driver	AC Input	Dimming	Minimum number of fixtures	Maximum number of fixtures	Current setting (mA)
--------	----------	---------	----------------------------	----------------------------	----------------------

Group 1:

Group 2:

Group 3:

Group 4:

Please note: Dimming/control wiring not shown in the diagram above. A relay or Powerpack may be required. Running separate line side (line voltage) and controls (low voltage) leads may be required. Refer to the NEC, your local jurisdiction and the 0-10V dimmer or dimming system manufacturer you are planning on using for additional considerations on how to wire the 0-10V control leads.

inter•lux

Project:	Type:	Date:
Manufacturer:	Fixture:	Page:

Dry Location Enclosure

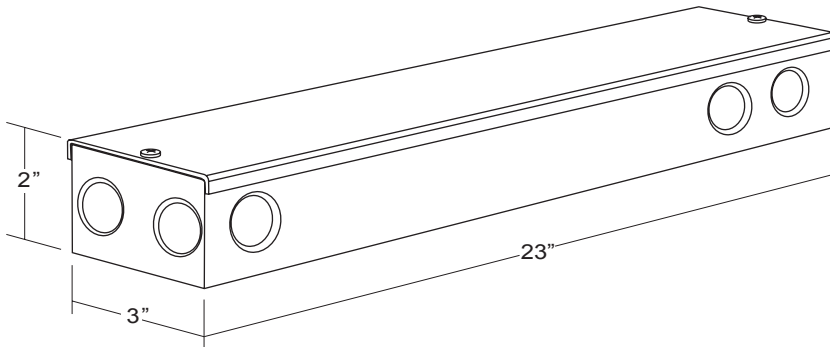

Maximum Wiring Distance Guide*

Wire Gauge	Maximum Lead Length
18	72 ft (22 m)
16	118 ft (36 m)
14	150 ft (46 m)
12	200 ft (61 m)

*Actual distance must be calculated by installer.
Must comply with NEC code.

Our drivers are programmed to Linear dimming curve by default.

Compatible/Recommended dimmers and interfaces*:

- Lutron Diva DVSTV (Wallbox dimmer)
- Lutron Nova T NTSTV (Wallbox dimmer)
- Lutron Maestro MS-Z101/MS-Z101-V (Wallbox dimmer/sensor)
- Lutron PowPak 0-10V RMJ-5T-DV-B (Energi Tripak)
- Lutron GRX-TVI (0-10V interface for Grafik QS and some commercial dimming panels)
- Lutron TVI-LMF-2A (EcoSystem to 0-10V interface)
- Lutron QSN-4T16-S (Energi Savr Node 0-10V)
- Lutron TVM2 module (HomeWorks and commercial dimming panels)

**Consult factory for any dimmer not listed above or if programming to a logarithmic dimming curve is required before ordering the drivers.*



100W Dimmable LED Driver

SOLOdrive AC is a constant current LED driver with multiple LED outputs that are controlled over a single channel. It is targeted at larger networked and smaller standalone installations that require dimmable, high-power, general white LED lighting. SOLOdrive AC is available in a DALI and 0-10V compatible version.

Applications

- Office lighting
- Architectural lighting
- Hospitality lighting
- High and Low Bay lighting
- Signage / advertising lighting
- Retail lighting
- Public area / park / street lighting
- Display lighting

Features & benefits

Input

- Voltage: 120 - 277 VAC
- Current, max:
 - 1A at 120V/60Hz
 - 0.5A at 230V/50Hz
 - 0.45A at 277V/60Hz
- Frequency: 50/60Hz

Output

- Voltage: 60V max, 57V typ
- Current range: configurable from 200mA to 1,050mA
- Power: 100W max

General

- Power factor: > 0.94
- DALI or 0-10V compatible. SOLOdrive 1061 is a current source driver, compatible with both current sink and current source controls.
- Hybrid HydraDrive: 20-bit resolution
- Dimming control: smooth dimming from 100% to 0%, choice of linear or logarithmic dimming curve
- High efficiency over a wide power and voltage range: 90% at full load, ≥ 87% above 50W output
- Maximum (rated) power available over wide LED voltage (30-60V) and LED current range (200-1,050mA)
- Programmable NTC temperature, dimming curve, minimum dimming level and - per output - LED current



SOLOdrive 1061/A



SOLOdrive 1061/S



SOLOdrive 1061/M

Product offering

Description

SOLOdrive AC, 100W, DALI, 1 ballast, constant current, 4x 60V LED outputs, long metal/plastic
 SOLOdrive AC, 100W, DALI, 1 ballast, constant current, 4x 60V LED outputs, square metal
 SOLOdrive AC, 100W, DALI, 1 ballast, constant current, 4x 60V LED outputs, long metal

Product

SOLO 1060/A
 SOLO 1060/S
 SOLO 1060/M

Order no.

SL1060A1
 SL1060S1
 SL1060M1

SOLOdrive AC, 100W, 0-10V, 1 control channel, constant current, 4x 60V LED outputs, long metal/plastic
 SOLOdrive AC, 100W, 0-10V, 1 control channel, constant current, 4x 60V LED outputs, square metal
 SOLOdrive AC, 100W, 0-10V, 1 control channel, constant current, 4x 60V LED outputs, long metal

SOLO 1061/A
 SOLO 1061/S
 SOLO 1061/M

SL1061A1
 SL1061S1
 SL1061M1

Dimensions, weight, packaging

SOLOdrive 106*/A

- Weight: 705 g, 26 oz
- Packaging: 20 pcs/carton

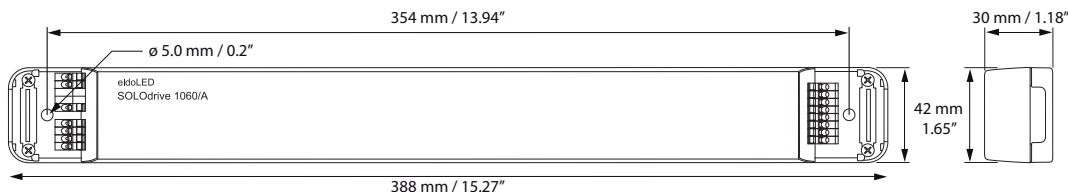

SOLOdrive 106*/S

- Weight: 880 g, 31 oz
- Packaging: 20 pcs/carton

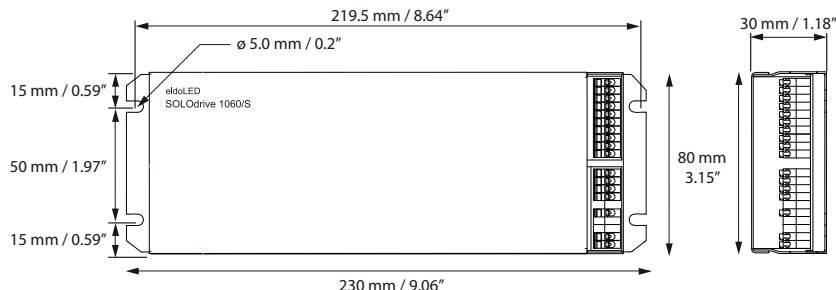

SOLOdrive 106*/M

- Weight: 880 g, 31 oz
- Packaging: 20 pcs/carton

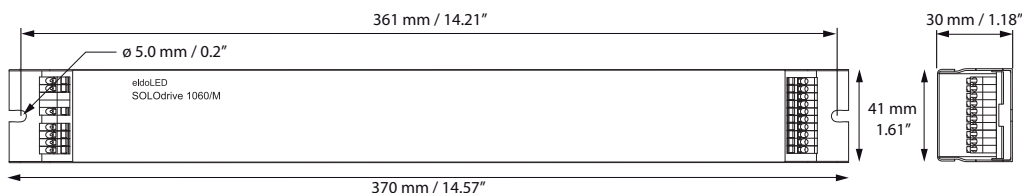

Connections

Connectors

- Power: Line, Neutral and Ground
- DALI or 0-10V: + and - (x2)
- LED outputs: 1 ballast: + and - (x4)
- LEDcode / NTC: + and -

Wiring

- Cross section: 0.5 - 1.5 mm², AWG 20 - 16
- Strip length: 9 mm / 0.35 in.

Other information

Certifications

- IEC 61347-1, IEC 61347-2-13, IEC 62384 + A1, EN 55015 + A1, EN 55022 + A1, IEC 61000-3-2, IEC 61547 + A1, IEC 62386-207
- CE
- ENEC by VDE
- UL: Recognized Component for US and Canada (file no. E333135), according to UL1310 and UL8750.
US: Class 2 output. Canada: Non-Class 2 output.

Environmental ratings

- Ta range: -40°C...+50°C / -40°F...+122°F
- Tc max: 90°C / 194°F (106*/A), 85°C / 185°F (106*/M), 83°C / 181°F (106*/S)
- For use in damp and dry locations

Control compatibility

- DALI control gear
- Standard 0-10V wall mount dimmers and switch controls (both current sink and current source)



Europe, Rest of World

eldoLED Europe bv
Luchthavenweg 18a
NL-5657 EB Eindhoven
The Netherlands
T: +31 40 2054050
F: +31 40 2054058

North America

eldoLED America, Inc.
1762 Technology Drive #226
San Jose, CA 95110
USA
T: +1 408 451 9333
F: +1 408 451 9335

Other documentation and support

Visit www.eldoled.com/ACsupport for further documentation such as quick start guide, wiring diagram, tech sheet and 3D IGES files.

Warranty

eldoLED represents and warrants that for a period of 3 (three) years, as of the date of invoice, Products materially meet the specifications and specifically agreed upon quality, both as stated in the applicable datasheet and/or written design-in specifications, or as stated in writing otherwise by eldoLED, provided that these specifications are explicitly designated by eldoLED as "warranted specifications".

For the complete warranty text, visit www.eldoled.com/terms.

Sales support EU & Rest of World: sales@eldoled.com
Sales support US/Canada: nasales@eldoled.com



Pay attention when connecting the LED groups:

- polarity reversal results in no light output and often damages the LEDs
- combining + and - of different groups damages the driver

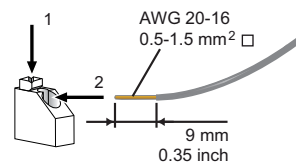
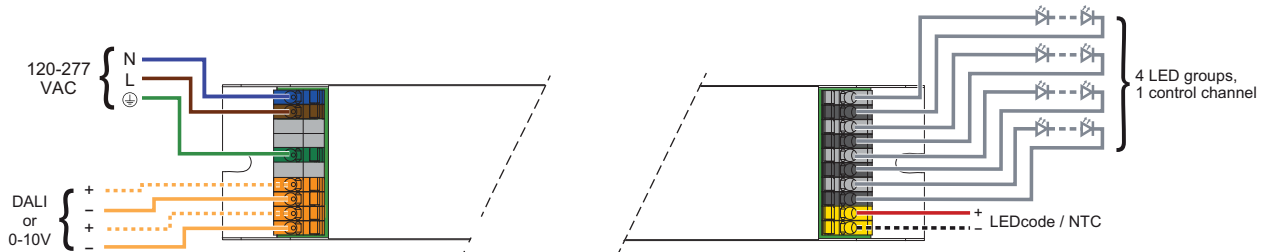

WARNING: Risk of electrical shock. May result in serious injury or death. Disconnect power before servicing or installing.



CAUTION: The device may only be connected and installed by a qualified electrician. All applicable regulations, legislation and building codes must be observed. Incorrect installation of the device can cause irreparable damage to the device and the connected LEDs.

120-277VAC

The driver accepts a universal mains voltage input of 120-277VAC, 50/60Hz.

DALI/0-10V

On SOLOdrive 1060, you can use these connectors to connect the driver to a DALI network. Always combine a DA+ and DA- connector for either data input or data output.

On SOLOdrive 1061, you can use these connectors to connect a 0-10V control device or 47kΩ potentiometer, allowing you to turn on/off and dim the light.

LED wiring distance

Maximum wiring distance at full load:

AWG value	20	19	18	17	16
Distance (m)	14	18	22	28	36
Distance (ft)	45.9	59	72.2	91.9	118.1

LED groups

Indicates the location of the connectors for your LED groups. All LED groups are controlled over the same control channel (DALI ballast).

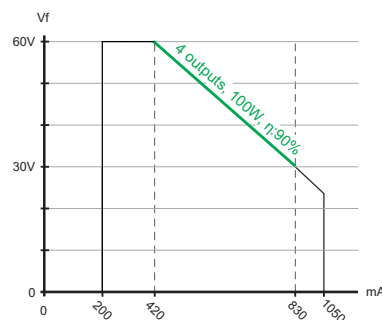

Output voltage vs output current for 4 outputs with symmetrical load
 $V_{f,typ}$ is 57V, LED current ranges from 200mA - 1050mA

LEDcode/NTC

Use these connectors to connect a 47kΩ negative temperature coefficient (NTC) thermistor for closed loop LED engine temperature control.

Connecting 3 LED groups

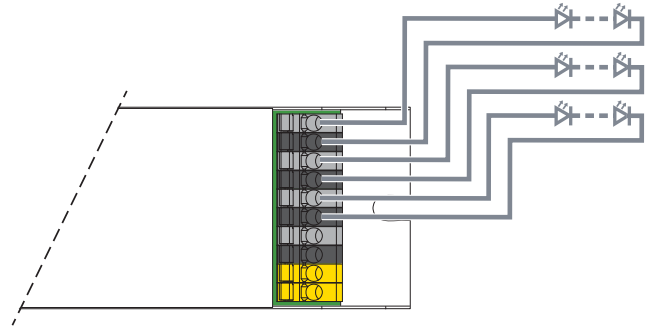
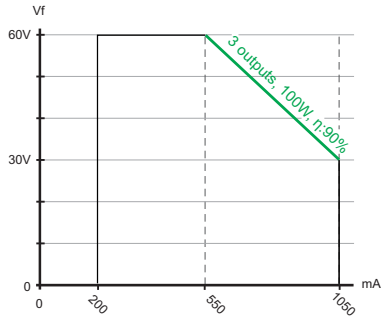

Output voltage vs output current for 3 outputs with symmetrical load
 $V_{f_{typ}}$ is 57V, LED current ranges from 200mA - 1050mA

Connecting 2 LED groups

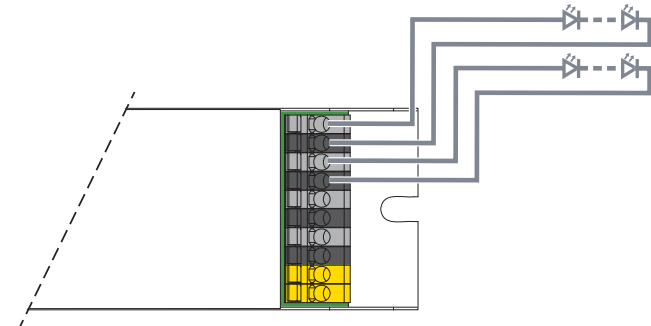
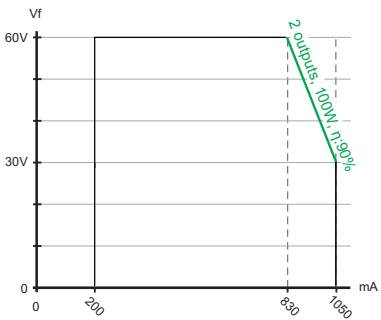

Output voltage vs output current for 2 outputs with symmetrical load
 $V_{f_{typ}}$ is 57V, LED current ranges from 200mA - 1050mA

Connecting 1 LED group

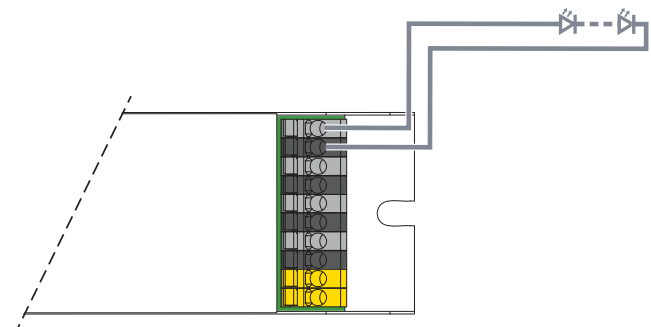
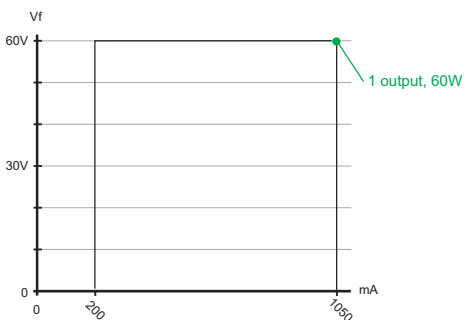

Output voltage vs output current for 1 output
 $V_{f_{typ}}$ is 57V, LED current ranges from 200mA - 1050mA