

ZTA.50 Surface +Zoom

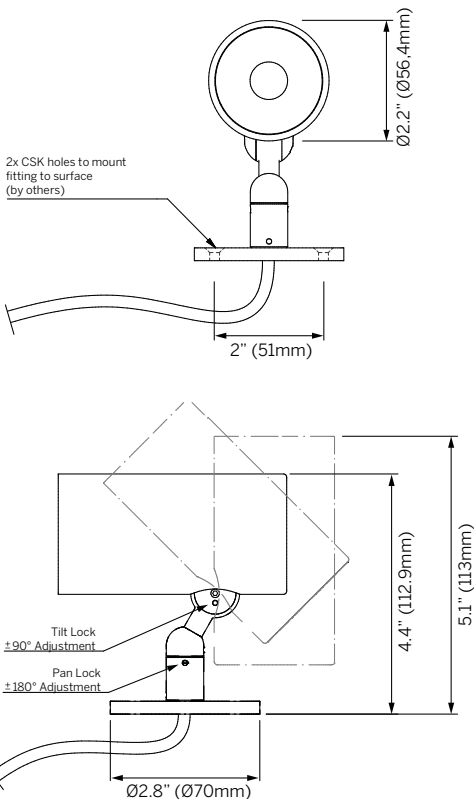
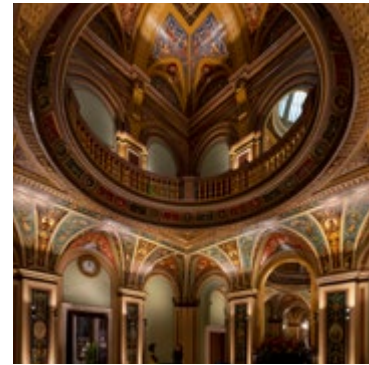

Luminaire

- Interior rated spot light with zoomable lens or fixed focus optics.
- Surface, stem or pole clamp mounted.
- Precision machined from 70 - 90% recycled aluminum.
- 95+ CRI with multiple CCTs and optics available.

Mounting

- SM = Surface Mounted
- ST6 = 6" Stem Mounted¹
- ST12 = 12" Stem Mounted¹
- ST19 = 19" Stem Mounted¹
- STXX = Specify Custom Length to nearest 0.25", 19" max¹
- PC = Pole Clamp (clamp only, contact us for custom pole options)¹
- FX = Flex Mounted (180° adjustable surface mounted, swivel arm)¹

Power²

- 4 = 4W (385lm initial at 450mA, 9.4Vf)
- 8 = 8W (798lm initial at 250mA, 34.1Vf)
- 12 = 12W (1513lm initial at 350mA, 36.9Vf)

CCT (95+ CRI)³

- 927 = 2700K
- 930 = 3000K
- 935 = 3500K
- 940 = 4000K

Optic

- Z = Zoom (14° x 48°), 8W Only
- VN1 = Very Narrow 1 (9°), 4W Only
- VN2 = Very Narrow 2 (14°), 8W Only
- VN3 = Very Narrow 3 (17°), 12W Only
- M = Medium (25°), 12W Only
- F = Flood (34°), 12W Only
- WF = Wide Flood (47°), 12W Only

Finish (interior always matte black)

- W = Pure White, RAL9010
- BL = Matte Black
- CF = Custom finish, specify RAL

Options^{4,5}

- SCS = Slash Cut Snoot
- SNT = Straight Snoot
- BD = Barn Doors

Accessories⁵

- CL = Clear Lens
- DL = Diffused Lens
- HCL = Honeycomb Louver
- SOL = Solite Lens
- SHS = Sharp Spread Lens
- SOS = Soft Spread Lens

Remote Driver⁶

- ECO30W-XXX = 0-10V EldoLED ECOdrive 30W
4W, 450mA, 1 fixtures
8W, 250mA, 1 fixture
12W, 350mA, 1 fixture
- SOLO50W-XXX = 0-10V EldoLED SOLOdrive 50W
4W, 450mA, 1-2 fixtures (1 per output)
8W, 250mA, 1-2 fixtures (1 per output)
12W, 350mA, 1-2 fixtures (1 per output)
- SOLO100W-XXX = 0-10V EldoLED SOLOdrive 100W
4W, 450mA, 1-4 fixtures (1 per output)
8W, 250mA, 1-4 fixtures (1 per output)
12W, 350mA, 1-4 fixtures (1 per output)

1. See page 5 for details.
2. Wattage shown is for LED only, system wattage varies depending on driver selected.
3. See photometric data sheet for delivered lumens.
4. Holds one option or accessory. See options on page 6 and accessories on page 7 for details.
5. Outside same finish as fixture, inside matte black.
6. See driver information for details.



Ordering Information





Model	Mounting	Power ²	CRI/CCT ³	Optic	Finish	Options ^{4,5}	Accessories ⁵	+	Driver ⁶
MS-ZTA50S	SM	4	927	VN1	W	SCS	CL		ECO30W-XXX SOLO50W-XXX SOLO100W-XXX
	ST6 ¹	8	930	VN2	BL	SNT	DL		
	ST12 ¹	12	935	VN3	CF	BD	HCL		
	ST19 ¹		940	M	SOL				
	STXX ¹			F	SHS				
	PC ¹			WF	SOS				
	FX ¹								
MS-ZTA50SZ (Zoom)		8		Z					

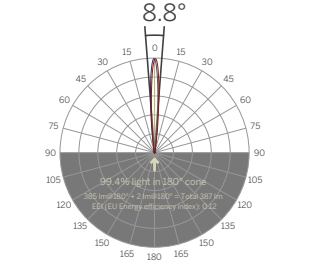



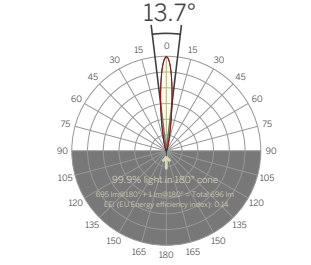

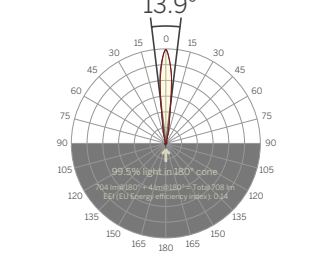

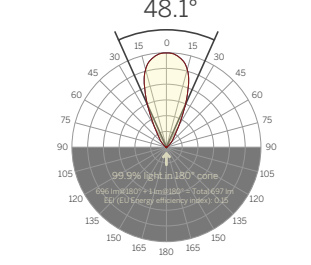
Photometry (4W)

Fitting	Polar diagram	LED	Supply	Power	Delivered output
 <p>4mm LES Very Narrow 1</p>	 <p>8.8°</p>	95 CRI, 3000K	Constant Current 450mA	3.9W	351lm

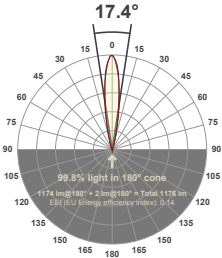
Photometry (8W)

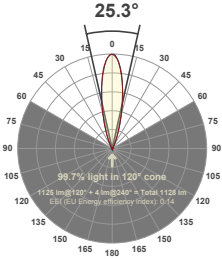
Fitting	Polar diagram	LED	Supply	Power	Delivered output
 <p>6mm LES Zoom Narrow 1</p>	 <p>13.7°</p>	95 CRI, 3000K	Constant Current 250mA	7.9W	695lm
 <p>6mm LES Very Narrow 2</p>	 <p>13.9°</p>	95 CRI, 3000K	Constant Current 250mA	7.9W	704lm
 <p>6mm LES Zoom Wide</p>	 <p>48.1°</p>	95 CRI, 3000K	Constant Current 250mA	7.9W	696lm

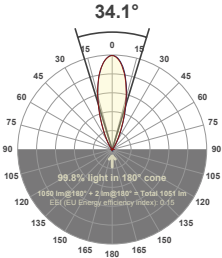
Photometry (12W)

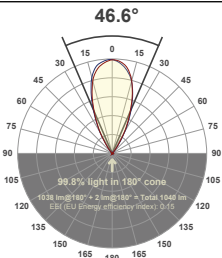
Fitting	Polar diagram	LED	Supply	Power	Delivered output
 <p>9mm LES Very Narrow 3</p>		95 CRI, 3000K	Constant Current 350mA	11.9W	1174lm
 <p>9mm LES Medium</p>		95 CRI, 3000K	Constant Current 350mA	11.9W	1125lm
 <p>9mm LES Flood</p>		95 CRI, 3000K	Constant Current 350mA	11.9W	1050lm
 <p>9mm LES Wide Flood</p>		95 CRI, 3000K	Constant Current 350mA	11.9W	1038lm

Wiring

Constant Current

Note that while constant current light sources can be wired in series, the number of fittings that can be wired in series is limited by the forward Voltage of the LED.

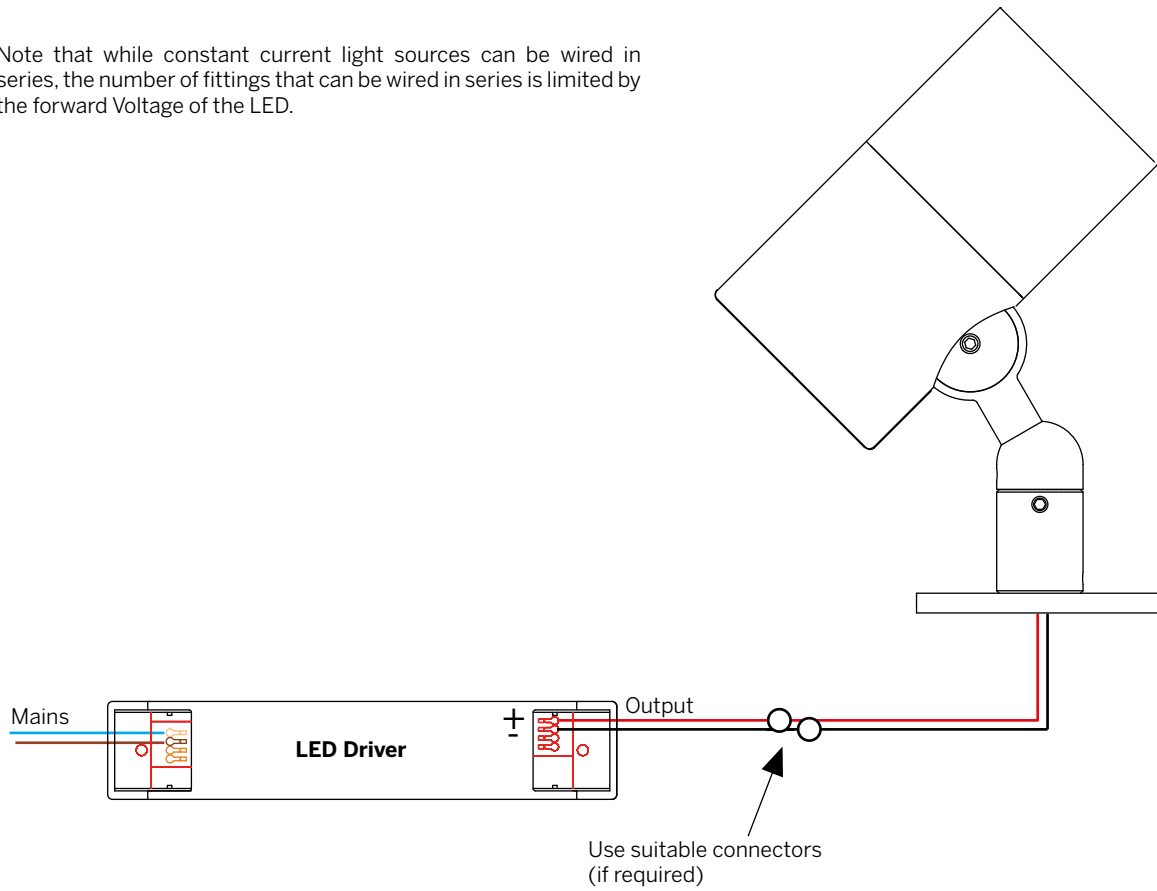

Mounting Options

Stem Mounted (STXX)

Height can be customized

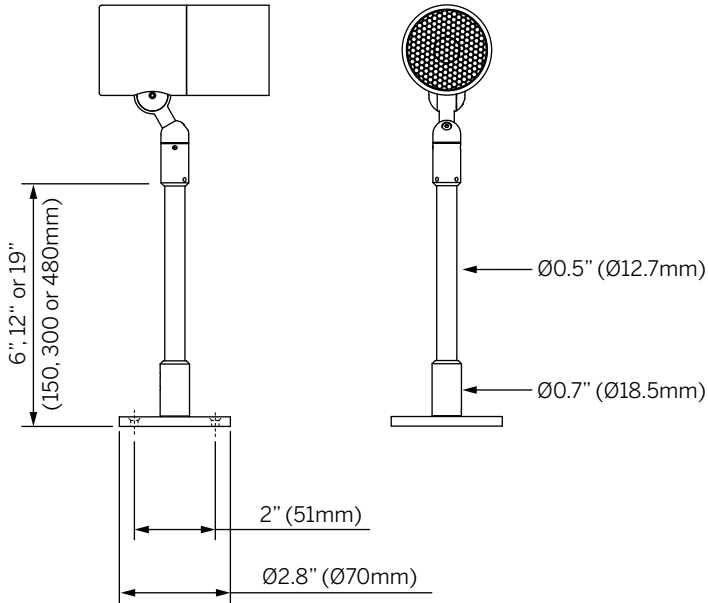

Pole Clamp (PC) (Clamp Only)

Contact us for custom pole options

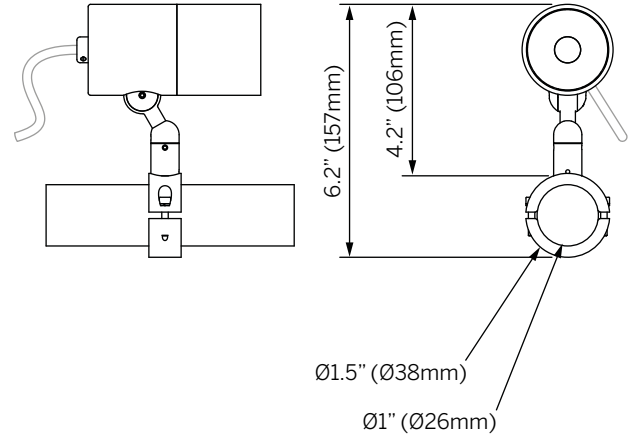

Flex Mounted (FX)

Maximum bending radius 3" (75mm)

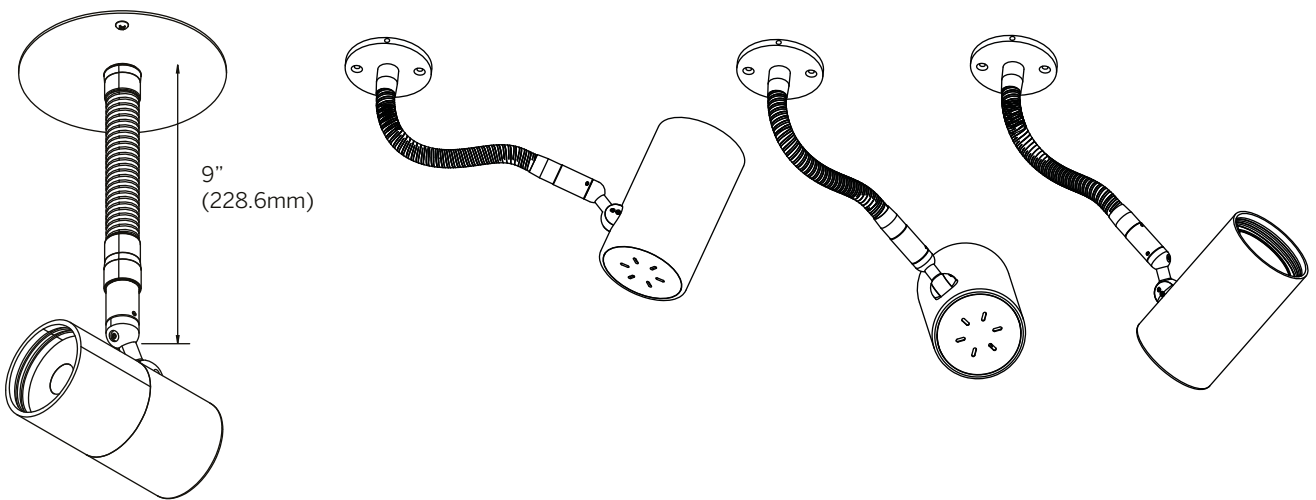

Options

Slash Cut Snoot 30° 2" (SCS)

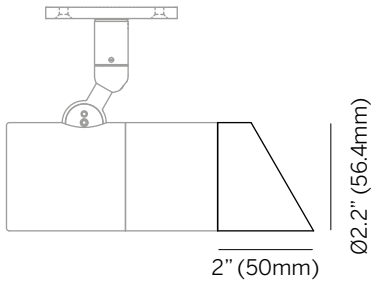

Straight Snoot 2" (SNT)

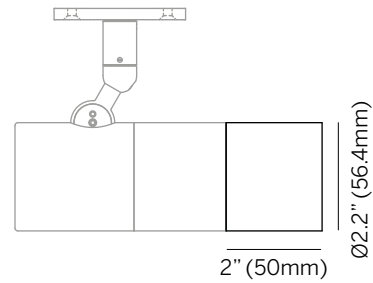

Barn Doors (BD)

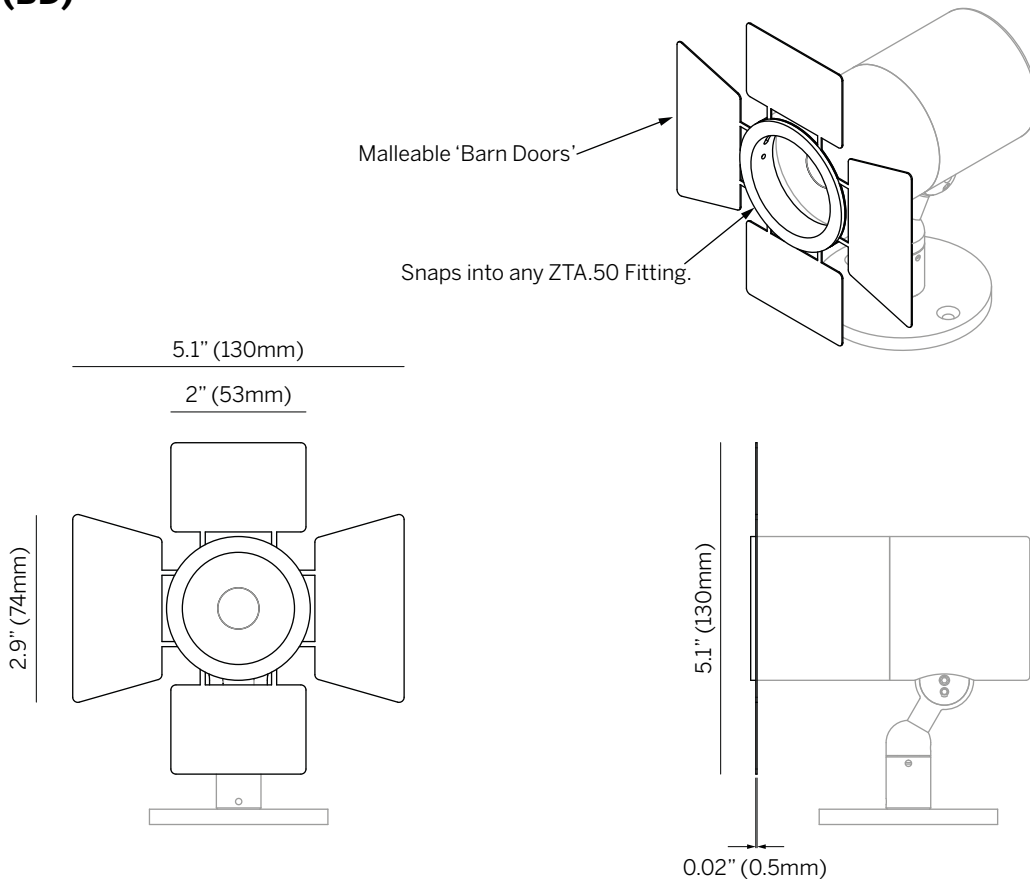

Accessories

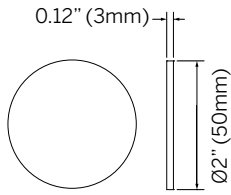

Clear Lens

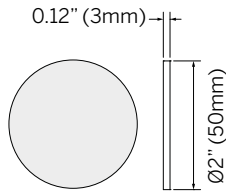

Diffused Lens
(Softens beam)

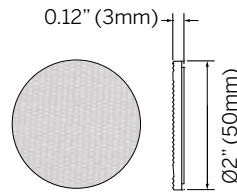

Solite Lens
(Diffuses light)

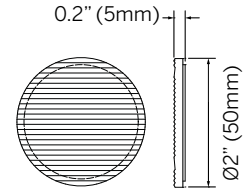

Sharp Spread Lens
(Sharp elliptical beam)

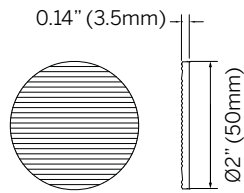

Soft Spread Lens
(Soft elliptical beam)

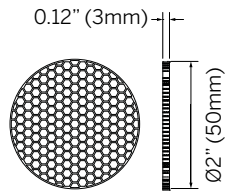

Honeycomb Louver
(Reduces glare)