

**Constant current fixtures are to be wired in SERIES and require a MINIMUM and MAXIMUM number of fixtures connected to a driver as indicated on the following page.**

**NOTE:**

**Powering or testing less than the minimum number of fixtures per driver**

**or**

**connecting fixtures with the driver powered (live wired)**

**or**

**wiring them in parallel will IMMEDIATELY and PERMANENTLY DESTROY the fixtures and void the warranty.**

**Carefully read instructions prior to installation and testing.**

# Constant Current drivers

## Wiring Key Points

1. This product shall be installed by a qualified electrician.
2. Make sure the main power supply to the driver is turned off when wiring either the LEDs or driver.
3. LEDs shall be wired in series as shown in wiring diagram. CAUTION: parallel wiring will damage LEDs.
4. Wire shall be 18 awg stranded minimum. Large gauge wire shall be used to limit voltage drop in order to maintain the proper operating voltage. Take every precaution to avoid interference from other electrical circuits and equipment.
5. Dimming circuits are more sensitive to voltage drop and electrical interference from other electrical sources.
6. Isolating LED wiring by dedicated circuit for each control zone is recommended.
7. Contractor shall verify the fixture quantities connected to the driver are compatible with the driver's specifications prior to energizing the circuit.
8. All Class II power cable remote wiring by others.

**LED's can be permanently damaged if these points are not followed**

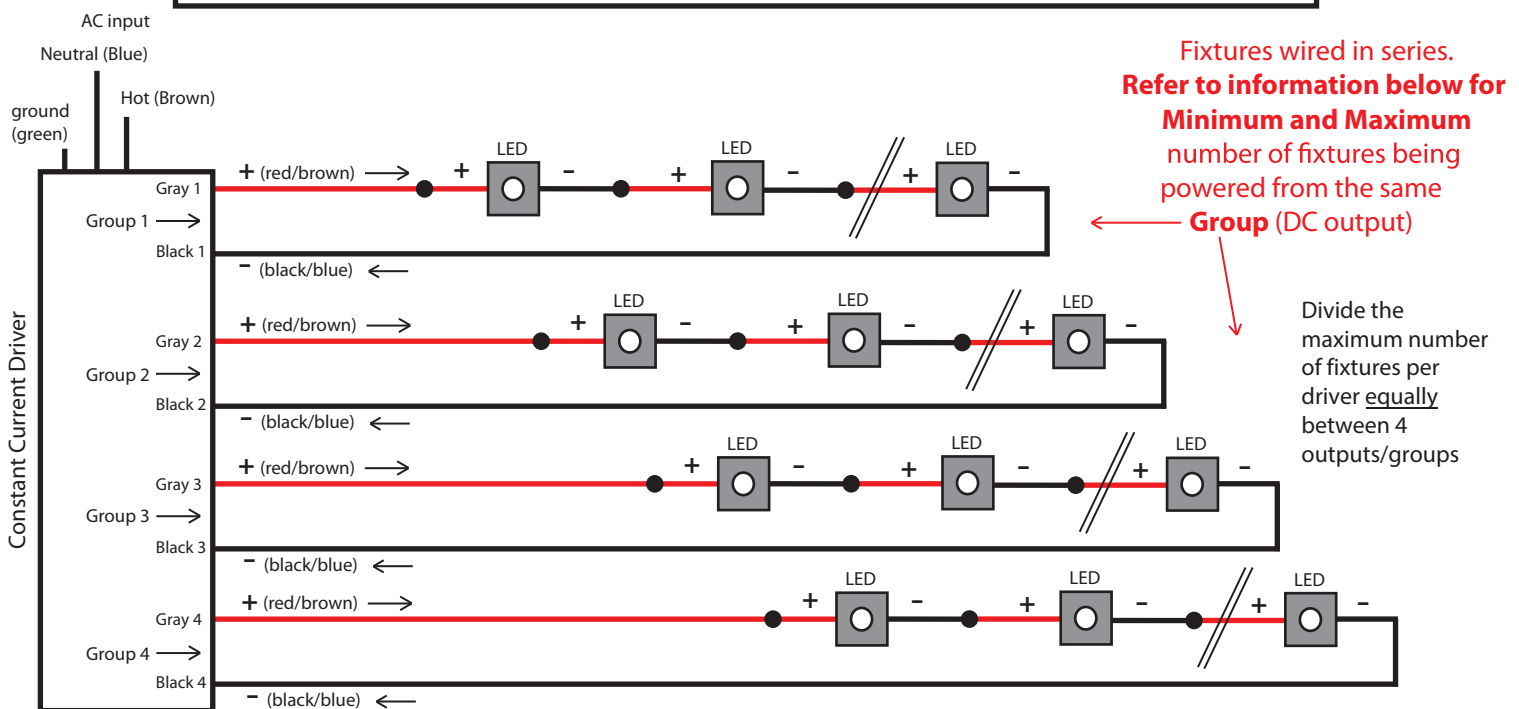

Driver	AC Input	Dimming	Minimum number of fixtures	Maximum number of fixtures	Current setting (mA)
SOLO 1061/M	120/277V	0-10V	Group 1:	1	
			Group 2:	0	
			Group 3:	0	
			Group 4:	0	

Please note: Dimming/control wiring not shown in the diagram above. A relay or Powerpack may be required. Running separate line side (line voltage) and controls (low voltage) leads may be required. Refer to the NEC, your local jurisdiction and the 0-10V dimmer or dimming system manufacturer you are planning on using for additional considerations on how to wire the 0-10V control leads.

**inter•lux**

Project:	Type:	Date:
Manufacturer:	Fixture:	

## Dry Location Enclosure

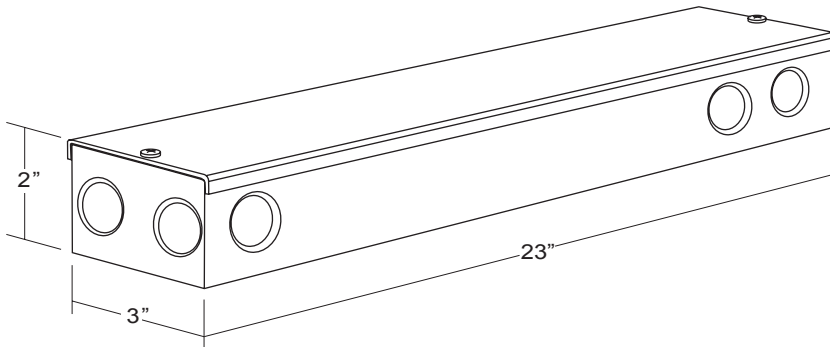

### Maximum Wiring Distance Guide\*

Wire Gauge	Maximum Lead Length
18	72 ft (22 m)
16	118 ft (36 m)
14	150 ft (46 m)
12	200 ft (61 m)

\*Actual distance must be calculated by installer.  
Must comply with NEC code.

Our drivers are programmed to Linear dimming curve by default.

Compatible/Recommended dimmers and interfaces\*:

- Lutron Diva DVSTV (Wallbox dimmer)
- Lutron Nova T NTSTV (Wallbox dimmer)
- Lutron Maestro MS-Z101/MS-Z101-V (Wallbox dimmer/sensor)
- Lutron PowPak 0-10V RMJ-5T-DV-B (Energi Tripak)
- Lutron GRX-TVI (0-10V interface for Grafik QS and some commercial dimming panels)
- Lutron TVI-LMF-2A (EcoSystem to 0-10V interface)
- Lutron QSN-4T16-S (Energi Savr Node 0-10V)
- Lutron TVM2 module (HomeWorks and commercial dimming panels)

*\*Consult factory for any dimmer not listed above or if programming to a logarithmic dimming curve is required before ordering the drivers.*



## 100W 0-10V 'Dim to Dark' LED Driver

### SOLOdrive

SOLOdrive offers industry-best Natural Dimming to dark - LED dimming made beautiful! With any dimmer, in any application. Symbiosis on SOLOdrive stands for unity, for the SOLOdrive working seamlessly together with LED modules, controls and intelligent luminaire elements.

### Product offering



#### SOLOdrive 1061/M

Part number (P/N)	SL1061M1
Product description	SOLOdrive AC, 100W, 0-10V, 1 control channel, constant current, 4x 57V outputs, side feed, long metal

### Features & benefits

Natural dimming	Dim to dark, smooth brightness changes, excellent flicker performance, adaptable dimming curves, configurable minimum dimming level
Symbiosis	Seamless interoperability with LED modules, controls and in-luminaire intelligent devices
LEDcode	Configurable design to work with most constant current LED modules and arrays, while providing a connection point to integrated peripheral controls
Programmable	Fine-tune your driver for any application
Performance	Universal input voltage range, low inrush current and total harmonic distortion (THD), high power factor and efficiency
Camera compatibility	Hybrid HydraDrive technology is proven to work in TV studios and security camera environments

### Programming tools

Programming interface	<a href="#">TOOLbox pro (TLU20504)</a>
Programming cable set	<a href="#">TOOLbox pro to LED driver, programming cable, 5pcs (TLC03051)</a>
Programming software	<a href="#">FluxTool</a>

### Warranty

Warranty period	<a href="#">General Terms and Conditions</a>
-----------------	--

### Order number configurator

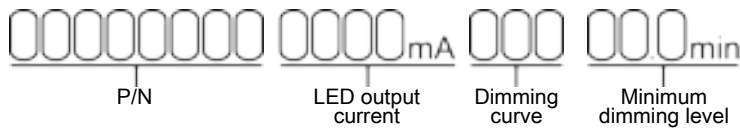

P/N	LED driver part number.
LED output current	Enter value in 1mA increments, e.g. "811" for 811mA
Dimming curve	"LOG" for logarithmic (default) "LIN" for linear
Minimum dimming level	Leave blank for default minimum dimming level of 0.1%. Specify in 0.1% increments, e.g. "10.5" for 10.5%.

**Input characteristics**

Nominal input voltage range AC	120 - 250V (ENEC), 120 - 277V (UL)
Nominal input voltage range DC	120 - 275V
Maximum input current	1.05A @ 120V / 60Hz
Input frequency range	50 - 60Hz
Efficiency at full load	90%
Power factor at full load	>0.94
THD at full load	<10%
Maximum inrush current	35A 240µs @ 120V / 60Hz
Surge protection	3kV differential mode (DM) 4kV common mode (CM)
Maximum standby power	<0.5W

**Output characteristics**

Maximum LED output power	100W
Number of LED outputs	4 (UL Class 2)
Programmable LED output current range	200 - 1050mA
LED output type	Programmable in 1mA increments within specified current range
LED output current tolerance	+/- 5% at programmed LED output current
LED output voltage range	2 - 57V

Operating window

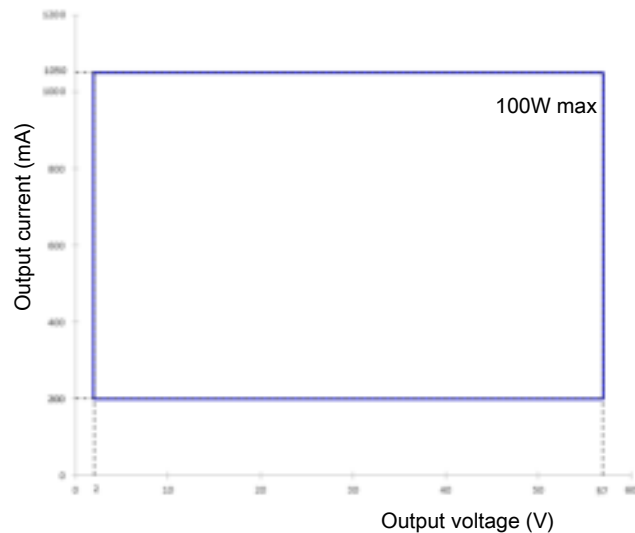

## Control characteristics

Control channels	1
Control protocol	0-10V
	LEDcode
Dimming range	100% - 0.1%
Dimming curve options	Logarithmic (default) Linear
Dimming method	Hybrid HydraDrive
0-10V current draw	<2mA

### 0-10V dimming chart

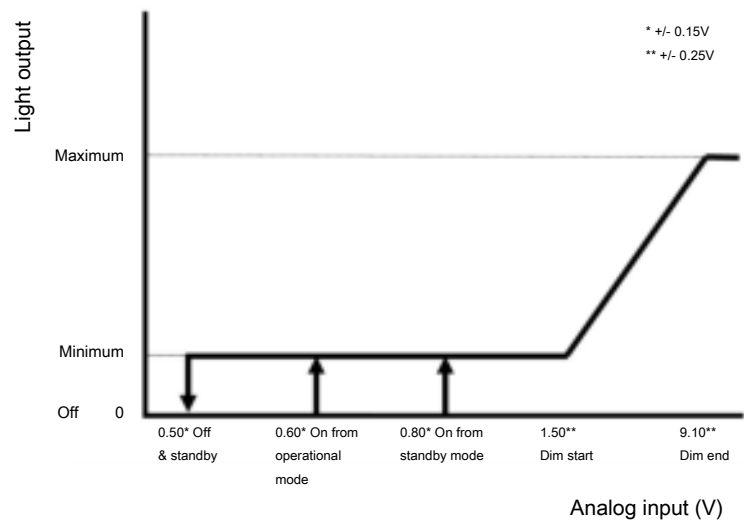

### Dimming curves

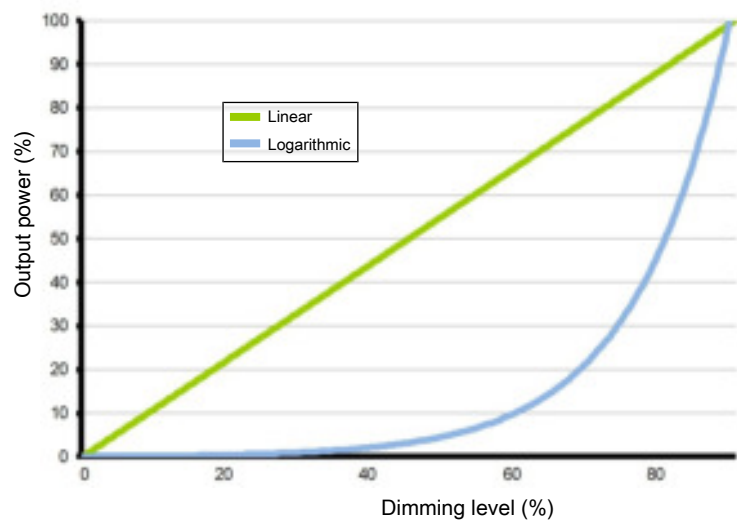

## Environmental conditions

Operating ambient temperature (Ta) range	-40 °C to +50 °C
Maximum operating case temperature (Tc max)	85 °C
Lifetime	50000 hours at a maximum case temperature (Tc) of 82 °C

## LED driver protection

Thermal	The LED output current is decreased whenever the internal LED driver temperature exceeds factory preset temperature. The LED output current is increased again once the internal LED driver temperature drops below this internal temperature threshold. If the internal LED driver temperature continues to increase, despite a decrease in output current, the LED driver will shut down.
LED output short circuit	The LED output current is cut off whenever the LED driver detects a short-circuit. The LED driver will attempt a restart every 400ms after a short-circuit is detected.
LED output overload	The LED driver decreases the LED output current sequentially, until it reaches its maximum rated power, whenever a load that exceeds the LED driver's maximum rated power is connected to the LED output.
Reverse polarity	The LED driver will not yield any current if the polarity of the load on the LED output is reversed. This situation will not damage the LED driver but may damage the LED load.

## LED protection

Thermal protection LED	An external NTC thermistor, which is placed on a PCB near the LEDs, can be connected to the driver via the LEDcode/NTC terminals. The output current to the LEDs is then decreased by 75% whenever the NTC exceeds a maximum allowable temperature, which is specified by the user in the FluxTool software. The default NTC temperature limit is set to 70 °C.
Thermistor value	47kΩ
Suitable thermistors	leaded: Vishay, P/N 238164063473 screw: Vishay, P/N NTCASCWE3473J



### LED driver mechanical details



Length (L) typical: 370 mm / 14.57 in

Width (W) typical: 41 mm / 1.62 in

Height (H) typical: 30 mm / 1.18 in

3D files available on product web page IGS

Weight 846 g

Mounting torque Not to exceed 0.5Nm

### Connector layout



### Input wiring specifications

Connector type push-in terminals

Connector supplier and series Wago 250 series

Wire type solid or stranded copper

Wire core cross section 0.5 - 1.5 mm<sup>2</sup> AWG 20 – 16

Wire strip length 9.0 mm

**Output wiring specifications**

Connector type	push-in terminals
Connector supplier and series	Wago 250 series
Wire type	solid or stranded copper
Wire core cross section	0.5 - 1.5 mm <sup>2</sup> AWG 20 – 16
Wire strip length	9.0 mm
Maximum remote mounting distance of LED load	AWG 20 (0.52 mm <sup>2</sup> ) - 14 m / 46 ft AWG 19 (0.65 mm <sup>2</sup> ) - 18 m / 59 ft AWG 18 (0.82 mm <sup>2</sup> ) - 22 m / 72 ft AWG 17 (1.04 mm <sup>2</sup> ) - 28 m / 92 ft AWG 16 (1.31 mm <sup>2</sup> ) - 36 m / 118 ft

**Automatic circuit breakers (MCB)**

Maximum loading	MCB type	B10	B13	B16	C10	C13	C16
	Number of LED drivers	5	6	8	8	10	13

**Standards and compliance**

UL, recognized component	UL 1310 UL 8750 (Class 2 output)
ENEC safety	EN 61347-1 EN 61347-2-13 (Emergency lighting)
ENEC performance	EN 62384
Conducted emissions	EN 55015
Radiated emissions	EN 55015
Radio disturbance characteristics	EN 55022
Harmonic current emissions	EN 61000-3-2
Electromagnetic immunity	EN 61547
0-10V	IEC/EN 60929 annex E NOTE: From 0.6V to 10V eldoLED LED drivers comply with IEC/EN 60929 annex E. Below 0.6V eldoLED LED drivers comply with ABL 0-10V Design Spec v1.2 enabling standby mode. For detailed dimming characteristics see 0-10V response chart in Control Characteristics.
FCC	47 CFR Part 15 class B
RCM	AS/NZS 61347.1, AS/NZS 61347.2.13
Restriction of hazardous substances	RoHS3 (Directives 2011/65/EU-2015/863/EU)

**Certifications**



---

## Safety

---



FELV control terminals marked “Risk of electric shock” are not safe to touch. Dimming connected to FELV control terminal shall be insulated for Low Voltage supply of the control gear.

---



Risk of electrical shock. May result in serious injury or death. Disconnect power before servicing or installing.

---



The LED driver may only be connected and installed by a qualified electrician. All applicable regulations, legislation, and building codes must be observed. Incorrect installation of the LED driver can cause irreparable damage to the LED driver and the connected LEDs.

Pay attention when connecting the LEDs: polarity reversal results in no light output and often damages the LEDs.

---



LED drivers are designed and intended to operate LED loads only. Powering non-LED loads may push the LED driver outside its specified design limits and is, therefore, not covered by any warranty.

---



eldoLED products are designed to meet the performance specifications as outlined at certain operating conditions in the data sheet. It is the responsibility of the fixture manufacturer to test and validate the design and operation of the system under expected and potential use cases, including faults.

---



Please observe voltage drop over long cable lengths. Longer cable lengths increase EMI susceptibility.

---



Product renderings and dimensional drawings are generic for the housing type. Product label, connector type and quantity may vary.

---

---

### Europe, Rest of World

eldoLED B.V.  
Science Park Eindhoven 5125  
5692 ED Son  
The Netherlands

E: [info@eldoled.com](mailto:info@eldoled.com)  
W: [www.eldoled.com](http://www.eldoled.com)

---

### North America

eldoLED America  
One Lithonia Way  
Conyers, GA 30012  
USA

E: [info@eldoled.com](mailto:info@eldoled.com)  
W: [www.eldoled.com](http://www.eldoled.com)

---



Pay attention when connecting the LED groups:

- polarity reversal results in no light output and often damages the LEDs
- combining + and - of different groups damages the driver

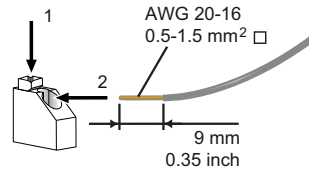
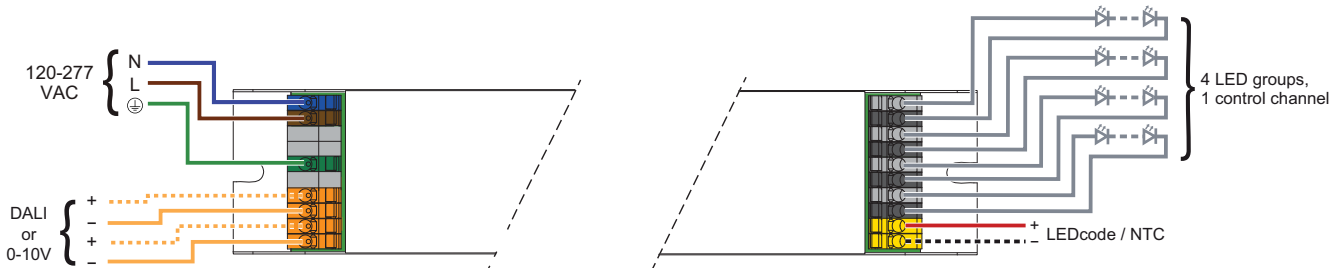

**WARNING:** Risk of electrical shock. May result in serious injury or death. Disconnect power before servicing or installing.



**CAUTION:** The device may only be connected and installed by a qualified electrician. All applicable regulations, legislation and building codes must be observed. Incorrect installation of the device can cause irreparable damage to the device and the connected LEDs.

### 120-277VAC

The driver accepts a universal mains voltage input of 120-277VAC, 50/60Hz.

### DALI/0-10V

On SOLOdrive 1060, you can use these connectors to connect the driver to a DALI network. Always combine a DA+ and DA- connector for either data input or data output.

On SOLOdrive 1061, you can use these connectors to connect a 0-10V control device or 47kΩ potentiometer, allowing you to turn on/off and dim the light.

### LED wire length

Maximum wire length from LED driver to LED engine at full load:

AWG value	20	19	18	17	16
Distance (m)	14	18	22	28	36
Distance (ft)	45.9	59	72.2	91.9	118.1



Please observe voltage drop over long wire lengths.



Longer wire lengths increase EMI susceptibility.

### LED groups

Indicates the location of the connectors for your LED groups. All LED groups are controlled over the same control channel (DALI ballast).

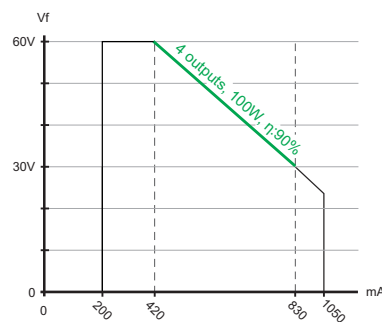

Output voltage vs output current for 4 outputs with symmetrical load

$V_{f_{typ}}$  is 57V, LED current ranges from 200mA - 1050mA

### LEDcode/NTC

Use these connectors to connect a 47kΩ negative temperature coefficient (NTC) thermistor for closed loop LED engine temperature control.

**Connecting 3 LED groups**

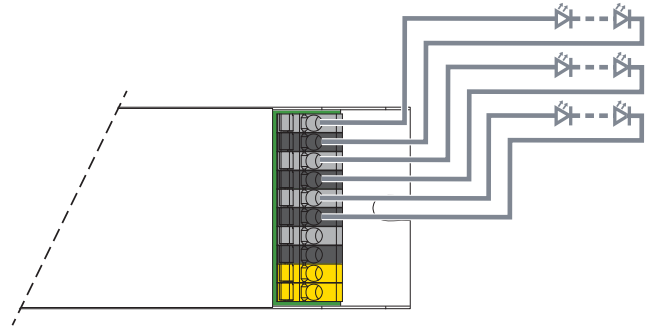
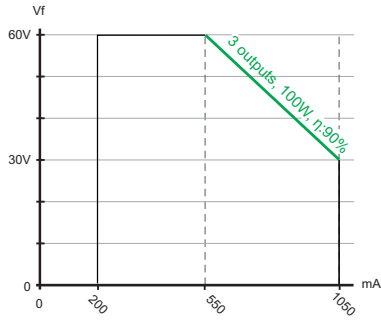

Output voltage vs output current for 3 outputs with symmetrical load  
 $V_{f_{typ}}$  is 57V, LED current ranges from 200mA - 1050mA

**Connecting 2 LED groups**

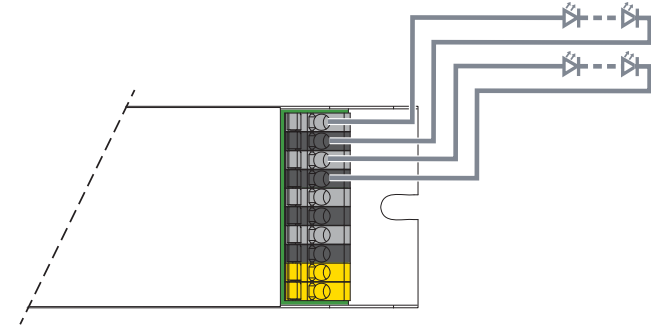
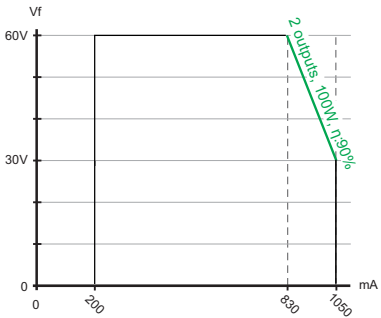

Output voltage vs output current for 2 outputs with symmetrical load  
 $V_{f_{typ}}$  is 57V, LED current ranges from 200mA - 1050mA

**Connecting 1 LED group**

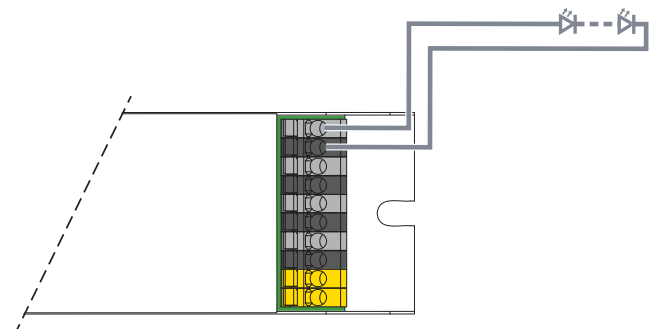
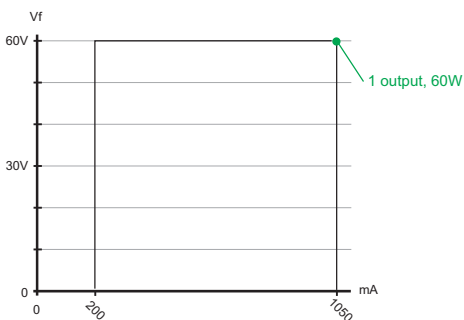

Output voltage vs output current for 1 output  
 $V_{f_{typ}}$  is 57V, LED current ranges from 200mA - 1050mA

**Eldoled ECO30W, SOLO50W, SOLO100W**

Fixture mA	Fixture Wattage	Max. number of fixtures per output (MULTI-OUTPUT DRIVER)	Max. total fixtures per ECO30W driver (1x output/driver)	Max. total fixtures per SOLO50W driver (2x outputs/driver)	Max. total fixtures per SOLO100W driver (4x outputs/driver)
180mA	7.0W	1	1	2	4
200mA	7.5W	1	1	2	4
220mA	0.6W	10	10	20	40
220mA	0.7W	10	10	20	40
220mA	1.9W	5	5	10	20
220mA	8.0W	1	1	2	4
220mA	9.0W	1	1	2	4
250mA	3.0W	3	3	6	12
300mA	12.0W	1	1	2	4
350mA	1.0W	10	10	20	40
350mA	1.5W	10	10	20	40
350mA	3.0W	5	5	10	20
350mA	4.0W	3	3	6	12
350mA	4.2W	3	3	6	12
350mA	12.0W	1	1	2	4
350mA	13.0W	1	1	2	4
400mA	15.0W	1	1	2	4
450mA	16.0W	1	1	2	4
500mA	1.5W	10	10	20	40
500mA	4.5W	4	4	8	16
500mA	6.0W	3	3	6	12
500mA	6.5W	3	3	4	8
500mA	9.0W	2	2	4	8
500mA	13.0W	1	1	2	4
500mA	14.0W	1	1	2	4
500mA	18.0W	1	1	2	4
500mA	20.0W	1	1	2	4
570mA	63.0W	1*	N/A	N/A	1
580mA	20.0W	1	1	2	4
630mA	2.0W	10	10	16	32
630mA	2.0W	10	10	16	32
630mA	4.0W	6	6	10	20
630mA	6.0W	3	3	6	12
630mA	7.0W	3	3	4	8
630mA	7.2W	3	3	4	8
630mA	7.5W	3	3	4	8
630mA	8.0W	3	3	4	8
630mA	9.0W	2	2	4	8
630mA	12.0W	2	2	2	4
630mA	18.0W	1	1	2	4
630mA	23.0W	1	1	1	3
630mA	24.0W	1	1	1	3
660mA	45.0W	1*	N/A	N/A	1
700mA	2.0W	10	10	16	32
700mA	6.3W	3	3	6	12
700mA	6.5W	3	3	4	8
700mA	8.0W	3	3	4	8
700mA	13.0W	1	1	2	4
700mA	21.0W	1	1	1	3
700mA	24.0W	1	1	1	3
700mA	25.0W	1*	N/A	1	3
800mA	10.0W	2	2	2	4
840mA	30.0W	1*	N/A	1	2
850mA	60.0W	1*	N/A	N/A	1
900mA	33.0W	1*	N/A	1	2
900mA	40.0W	1*	N/A	1	2
900mA	42.0W	1*	N/A	1	2
950mA	34.0W	1*	N/A	1	2
950mA	35.0W	1*	N/A	1	2
1050mA	48.0W	1*	N/A	N/A	1
1250mA	45.0W	1*	N/A	N/A	1
1250mA	46.0W	1*	N/A	N/A	1
1300mA	46.0W	1*	N/A	N/A	1
1850mA	54.0W	1*	N/A	N/A	1

All Fixtures **WIRED IN SERIES**

Consult factory for any combination not listed above.

\*Not all of the driver's outputs used. Where applicable, please check the maximum number of fixtures for the entire driver.