

Complete Downlight Range



whitegoods



whitegoods

Whitegoods has developed a complete range of Downlights which utilize the form factor of LED to reduce even further their visual impact, and of course they all hold true to our constant principles.

Our Philosophy

- Reduction of detail
- Seamless architectural integration
- Logical, modular systems and families of products
- Ease of specification, installation and maintenance

Brightness is in the eye of the beholder

Our perception of the 'brightness' of a space is primarily based on what we see at a glance as we scan around us. In architecture this is often walls and other vertical surfaces. Therefore, how well the walls are illuminated at approximately eye level is the key factor in our determination of how well a space is lit.

Within such a space then, which surfaces and / or planes should be revealed in order to support the architectural concept?

What opportunities are there to bring light to these surfaces?

Where should the light come from?

What should the properties of that light be (how much, how focused, what spread of light, and at what angle should it fall onto the surface...)?

Whitegoods provides tools for the designer to address these questions and answer them with light, while the luminaires make the absolute minimum visual impact on the space.

Whitegoods fixtures provide all-round vertical illumination with high angle secondary diffuse light, filling the volume with light, creating visual brightness and visual comfort too. An array of optical accessories and integration profiles further expands the uses to include grazing, cove and perimeter lighting solutions.

Downlights

Whitegoods offers a comprehensive range of downlights with functionality and performance characteristics to suit all applications and budgets.







Nonetheless, all our luminaires are designed and manufactured to the highest possible standards, incorporating many unique features and utilizing the best available materials and components. We are constantly seeking to deliver the best possible quality of light with our luminaires, so you can be sure that the light engines we select are as good as it gets: market leading performance across the range.

1.5" ProTools	32
2.4" Downlights	60
3" ProTools	70
4" ProTools	96
ProTools Cylinders	120
Square Ceiling Floor Wash	150





Complete Downlight Range









1.5" ProTools

	1.5" ProTools Downlight Round Recessed	44
	1.5" ProTools Downlight Square Recessed	46
	1.5" ProTools Adjustable Round Recessed	48
	1.5" ProTools Adjustable Square Recessed	50
	1.5" ProTools Wall Wash Round Recessed	52
	1.5" ProTools Wall Wash Square Recessed	54
	1.5" ProTools Downlight Round Suspended Cylinder	56









2.4" Downlights

	2.4" General Downlight Round Recessed	66
	2.4" General Downlight Wall Wash	68

3" ProTools

	3" ProTools Downlight Round Recessed	80
	3" ProTools Downlight Square Recessed	82
	3" ProTools Adjustable Round Recessed	84
	3" ProTools Adjustable Square Recessed	86
	3" ProTools Wall Wash Round Recessed	88
	3" ProTools Wall Wash Square Recessed	90
	3" ProTools Accent Wall Wash Round Recessed	92
	3" ProTools Accent Wall Wash Square Recessed	94

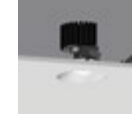
4" ProTools



	4" ProTools Downlight (Shallow) Round Recessed	104
	4" ProTools Downlight (Shallow) Square Recessed	106
	4" ProTools Downlight Round Recessed	108
	4" ProTools Downlight Square Recessed	110
	4" ProTools Adjustable Round Recessed	112
	4" ProTools Adjustable Square Recessed	114
	4" ProTools Wall Wash Round Recessed	116
	4" ProTools Wall Wash Square Recessed	118

Complete Downlight Range

ProTools Cylinders

	2.4" ProTools Downlight Round Cylinder	130
	2.4" ProTools Downlight Round Cylinder Tall	132
	2.4" ProTools Downlight Round Cylinder Wall Mount	134
	4" ProTools Downlight Round Cylinder	136
	4" ProTools Downlight Square Dark Cylinder	138
	4" ProTools Wall Wash Round Cylinder	140
	4" ProTools Wall Wash Square Cylinder	142
	4" ProTools Downlight Round Cylinder Wall Mount	144
	5.5" ProTools Downlight Round Cylinder	146

Ceiling / Floor Wash

	2.4" Square Ceiling / Floor Wash	152
	4" Square Ceiling / Floor Wash	154



Introduction

Application Guide

Whitegoods products are extremely versatile and can be integrated in a multitude of ways. Within this section of the book, you will find examples of a range of luminaires used in varying applications, including examples of the detailing used to achieve them.

Product Details

Within this section, you will find detailed information for all Whitegoods products, including key features, selectable options, critical dimensions, mounting possibilities and aesthetic choices. The information you need to help select the perfect luminaire for your application, without the clutter of every last technical detail. But, we also know that ultimately you and your team will need all the technical details, so we have developed a unique way to access and share detailed product specifications. Have a look at the section below, which explains how it works. It's simple and quick.

Accessing and Sharing Product Specifications

Whitegoods has developed a unique and innovative way to access and share product specifications, design guides and photometric files of the products you select.

Simply click the technical information button and you will be taken to the product page, where you can view and download technical information.

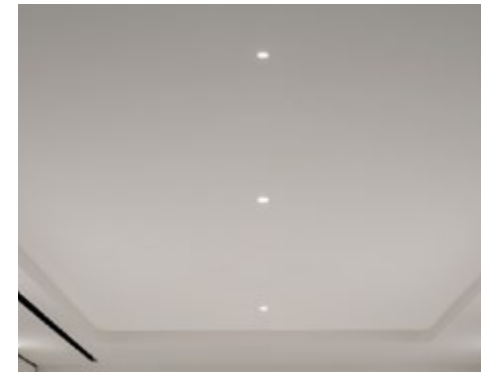
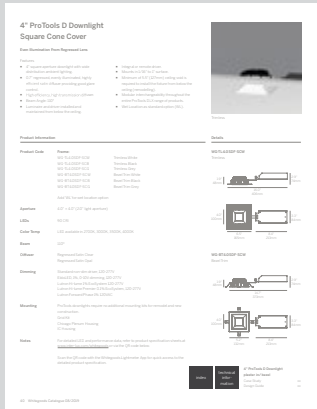

1.5" ProTools Downlights family offers minimal size, high performance fixed or adjustable downlights and wall washers available in round or square and trimmed or trimless. The fixtures are designed to provide superb glare control and offer optional accessories to further control the beam. Whitegoods attention to seamless integration with surrounding materials is prevalent throughout the offering.

- Downlight
- Wall Wash
- Adjustable
- Suspended Cylinder
- Wet Location



4" ProTools Downlights family offers mid size, high performance fixed or adjustable downlights and wall washers with a variety of cover options in round or square, trimmed or trimless and multiple luminaire configurations. The fixtures are simple in nature, designed for superb glare control, modularity and include Whitegoods attention to seamless integration with surrounding materials.

- Downlight (Shallow)
- Downlight
- Wall Wash
- Adjustable
- Wet Location

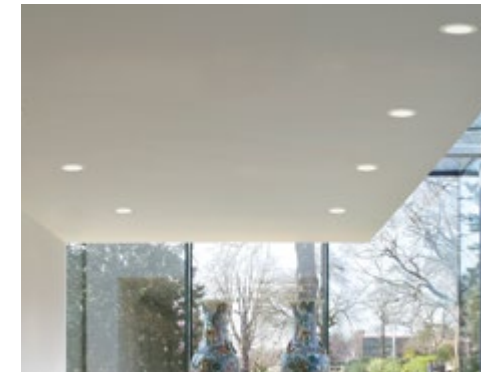

2.4" General Downlights (GDL) offers round flush lensed or regressed cone downlights or semi-recessed wall washers for indoor and outdoor applications with a bezel trim requiring very minimal ceiling depth while delivering low brightness illumination.

- Downlight
- Wall Wash
- Wet Location



ProTools Cylinders are a complete family of cylinder downlights for surface, suspended and wall mounted applications. 2.4", 4" and 5.5" cylinders with wide range of beam angles, lens options and wall wash available to fit a multitude of applications.

- Downlight Cylinder
- Wall Mount Cylinder
- Wall Wash Cylinder
- Wet Location



3" ProTools Downlights family offers small size, high performance fixed or adjustable downlights and wall washers with a variety of cover options available in round or square, trimmed or trimless and multiple luminaire configurations. The fixtures are simple in nature, designed for modularity and include Whitegoods attention to seamless integration with surrounding materials.

- Downlight
- Wall Wash
- Adjustable
- Wet Location

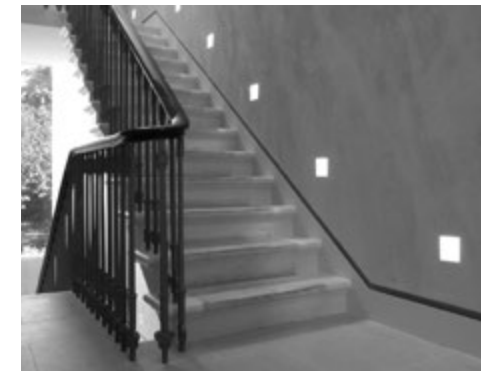

Square Ceiling / Floor Wash are compact, versatile luminaires equally suited to washing light onto a floor, or when inverted, onto the ceiling. Bezel or Plaster Trim in 2.4" and 4" ceiling or floor washers for drywall.

- Ceiling Wash
- Floor Wash

ProTools Modularity

The ProTools range of professional lighting tools has been developed as a flexible and adaptable system.

One unified range can meet the demands of all spaces within a project, from the simplest requirements to the most demanding, all with a genuinely matching aesthetic appearance.

By designing interchangeability into the range, inventory can be efficiently controlled to minimize costs and lead times.

Frame

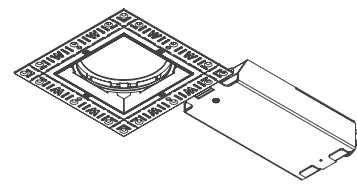

Square
Plaster Trim

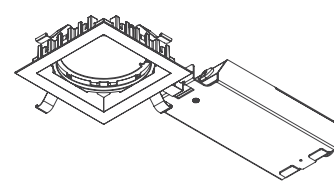

Square
Bezel Trim

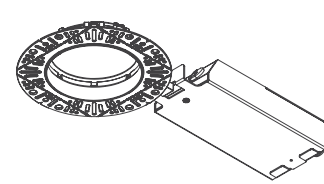

Round
Plaster Trim

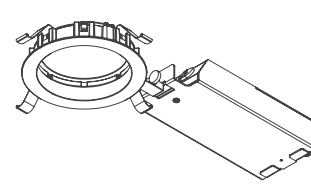

Round
Bezel Trim

The Frame installs into the ceiling and accepts any Insert and Driver option. Available in round or square, the Frame will install seamlessly into drywall, ACT and hard ceilings. The Frames are stocked at the factory to meet delivery requirements.

Select from Plaster Trim or Bezel once the mounting frame is fitted, it can accept any insert within the range, all of which can be installed and accessed from below.

The same is true for their driver enclosure.

Insert



Downlight
(Shallow)

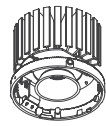

Fixed
Downlight

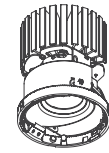

Adjustable



Wall Wash

The Insert is available in various light distributions, lumen output and color temperatures suited to the project.

All Inserts fit the selected Frame and are installed after the Frame is in place.

Choose the insert to suit your needs:

- Simple ambient light from the shallow downlight insert.
- Various beam angles from fixed downlight.
- Ultimate performance, superb glare control, lens options and a unique void shielding system with the adjustable insert.
- Even illumination of vertical surfaces with the wall wash insert.

Cover

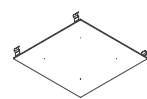

Flush
Diffuser

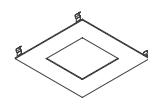

Recessed
Cone

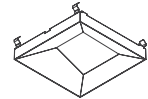

Regressed
Pinhole

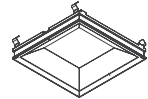

Asymmetric
Cone

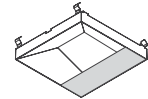

Wall Wash

A variety of Covers fit the Inserts for optical control, light distribution options and glare control. The Covers are also stocked for timely delivery to the site when needed.

Complete with your choice of cover:

- Flush Diffuser
- Recessed Cone
- Regressed Pinhole
- Asymmetric Cone
- Wall Wash
- Wet Location

ProTools 4" Downlights shown



Aim Stick & Aim Stick Laser

"Hot aiming" has been a buzzword in the lighting industry for decades. However, these days, it is something of a misnomer, as luminaires with LED technology run much cooler than their predecessors. Moreover, the traditional requirement for "lockable" fixtures related to the fact that their carefully aimed position would inevitably be disturbed during re-lamping every few thousand hours. The locking mechanism was there to minimize this. As LEDs will now more than likely outlast the serviceable life of an installation, this requirement is redundant.

Market leading COB LEDs mean that, once set, the luminaire is unlikely to need servicing.

Instead, we have ensured that the position of our adjustable downlights is "fixed as set" by default. The 365 degree rotation is incrementally defined by a spring-loaded ratchet system, ensuring that the position achieved is fixed the moment it is set. The aiming angle is likewise held fast by four, factory torque set, friction points.

Whitegoods products are designed with input from lighting designers who have years of real life, first hand experience of specifying and using luminaires of all kinds. We know that construction sites can be difficult places to work. Focusing a project when the BMS or lighting control system is also being commissioned can mean wasted hours waiting for the lights to come on. With ProTools the designer can focus the project with lights on or off, utilizing the unique aiming stick with laser sight, allowing total confidence that the luminaire will hit its target.

If you don't have one on hand, don't worry. A long thin screwdriver can be used to do the same job, albeit without the laser aiming of course.

Available on ProTools 3" and 4"

ProTools Aim Stick



ProTools Aim Stick Laser

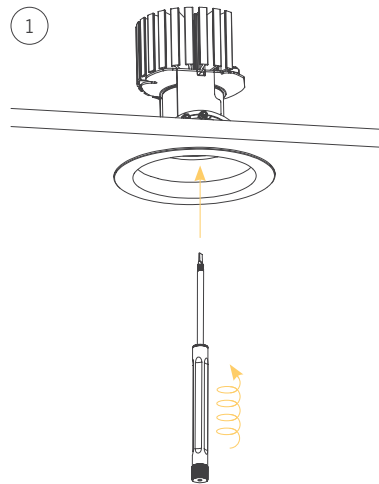

1 Locate the designated hole for the tool. Insert the ProTools Aim Stick into the housing and screw in a few short twists.

View from under the ProTools Adjustable.

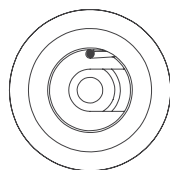

The designated hole for the Aim Stick is highlighted in yellow.

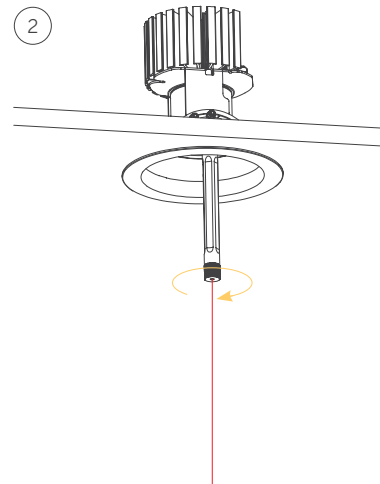

2 Activate the laser by rotating the black dial on the bottom of the Aim Stick clockwise.

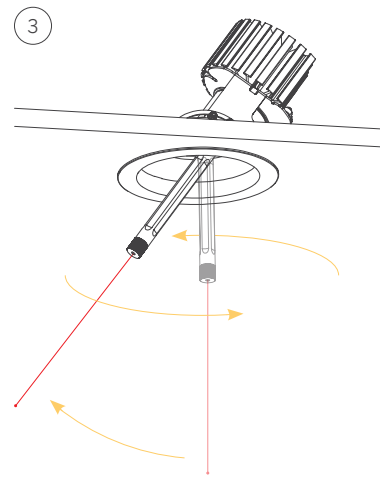

3 Use the tool to rotate the direction of the beam to the desired point. ProTools Adjustable can rotate 365° and has a tilt of 45°.

Once the required adjustment has been made, repeat steps 3-6 in reverse.

Aiming Geometry

ProTools Adjustable Downlights are designed with perfect aiming geometry. An innovative geometry ensures that the center of the beam passes through the center of the aperture, without the need for complicated gear driven mechanisms, just smart design.

PTD4"
45 degree tilt
365 degree rotation

PTD3"
25 degree tilt
365 degree rotation

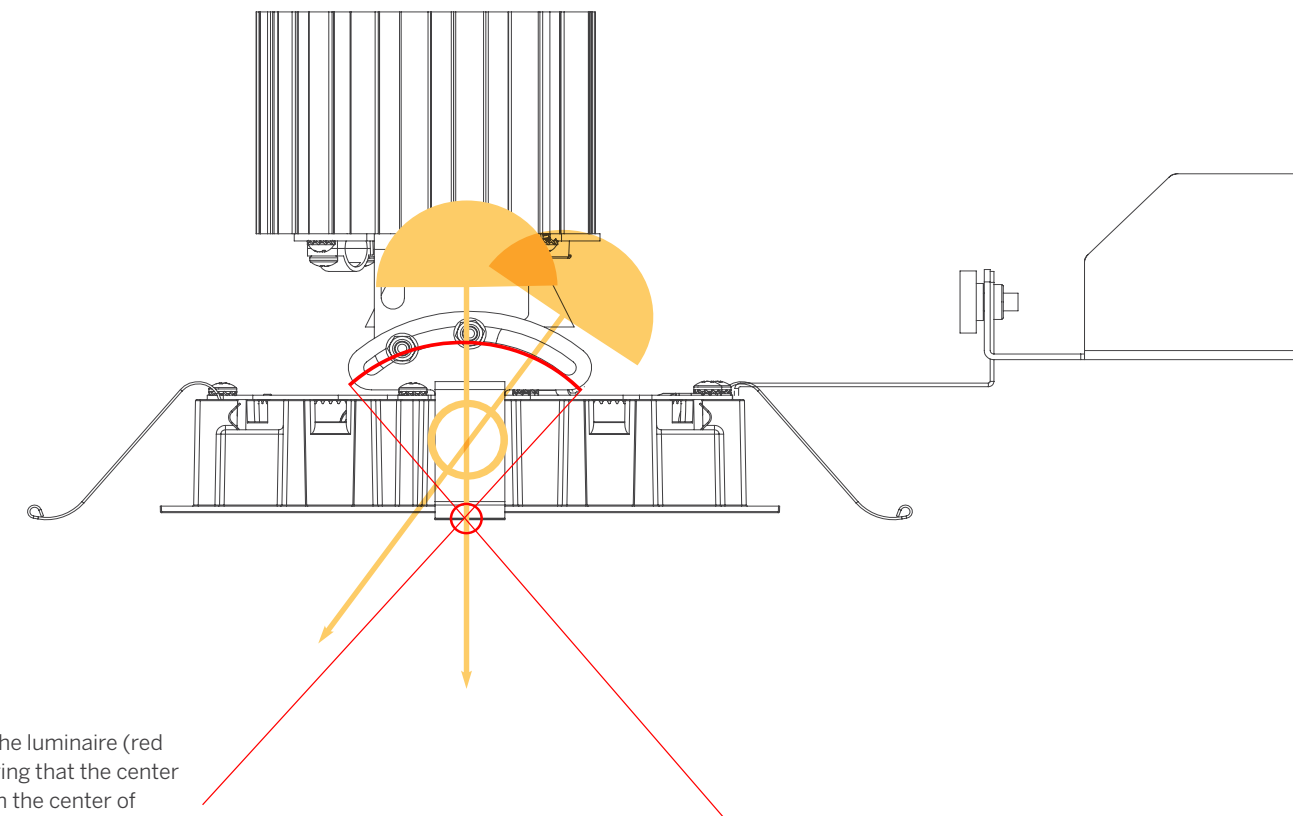

The focus of tilt is outside the luminaire (red reference lines), thus ensuring that the center of the beam passes through the center of aperture (yellow reference lines), regardless of the angle of illumination selected.



LED Technology

ProTools Downlights are designed with a flexible LED platform so that the light engine can be easily installed, field exchanged and updated as new technology evolves. ProTools Downlights utilize world-class COB LED devices that deliver consistent performance and the highest quality of light available in a configuration that will work effectively with today's optical systems.

- 92 CRI as standard with 98CRI as an option.
- 3 step MacAdam binning.
- Paired with highest quality drivers that deliver flicker-free, full-range dimming.
- Four standard color temperatures from 2700K-4000K.
- Warm-Dim available to emulate incandescent while dimming.
- Tunable White technology allows the occupant to dial in the color temperature.
- Compatible with all common dimmer and control standards such as 0-10V, 3-wire, Phase, and DALI.
- Wireless control capability using Casambi components.
- High efficiency design delivers a range of excellent performance characteristics, with output available exceeding 140 delivered lumens per watt.
- Used throughout Whitegoods Downlights for consistent color and performance throughout the range.
- 5-year warranty.

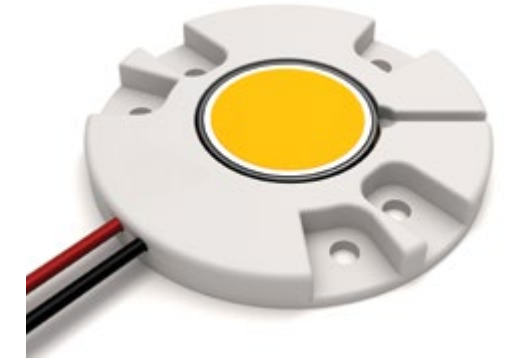

Tunable White

ProTools Downlights are available in Tunable White to allow you to select any color temperature between 1800K and 4000K, while maintaining the same high quality color rendering as the standard led. This feature is often used in health and wellness applications, as well as work spaces to increase productivity, architectural spaces to match natural light, and for design focus in retail and hospitality environments.

Available on ProTools 3" and 4"

Color Temperature	Description	Typical Usage
4000K	Cool	Office, Exterior
3500K	Neutral Cool	Office
3000K	Neutral Warm	Office, Residential
2700K	Warm: Halogen Incandescent	Residential, Hotel
1800K	Very Warm Incandescent	Residential



Warm Dim

Whitegoods Warm Dim lighting provides LED dimming and warm LED lights virtually indistinguishable from an incandescent light source. Designed to precisely mimic the black body curve of a standard 100W A19 lamp by gradually transitioning from 1800K to 3000K.

Available on ProTools 1.5", 3", 4" and Cylinders

Color Temperature	Description	Typical Usage
3000K	Neutral Warm	Office, Residential
2700K	Warm: Halogen Incandescent	Residential, Hotel
1800K	Very Warm Incandescent	Residential



Multiple Luminaire Configurations

Multiple fixture configurations can be accomplished using standard plaster-trim Downlight Frames.

With ProTools 3" and 4" Downlights you never have to purchase a specialized housing in order to realize a multiple configuration. In fact, you can simply snap off segments of the plaster-trim on standard product and field join the Frames during installation.

You simply specify the standard product.

- ① Select which side of the plaster trim to remove.

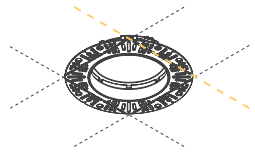

- ② Use a pair of multi-grip pliers and firmly snap off the trim with one swift movement.

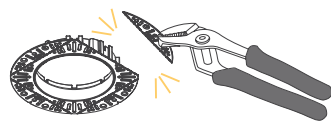

- ③ Installation frames can now be fixed directly next to one another...

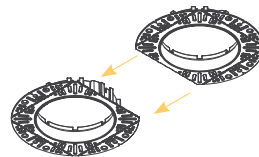

- ④ ...to create "multiple" configurations, which would usually require additional dedicated housings.

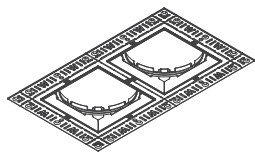

- ⑤ Any number of frames can be grouped together to form linear configurations.

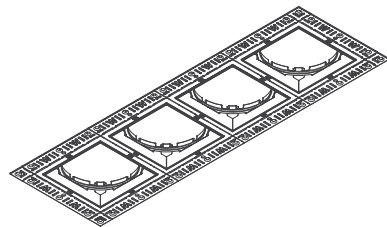

- ⑥ There are really no limits to the ways in which the installation frames can be combined.

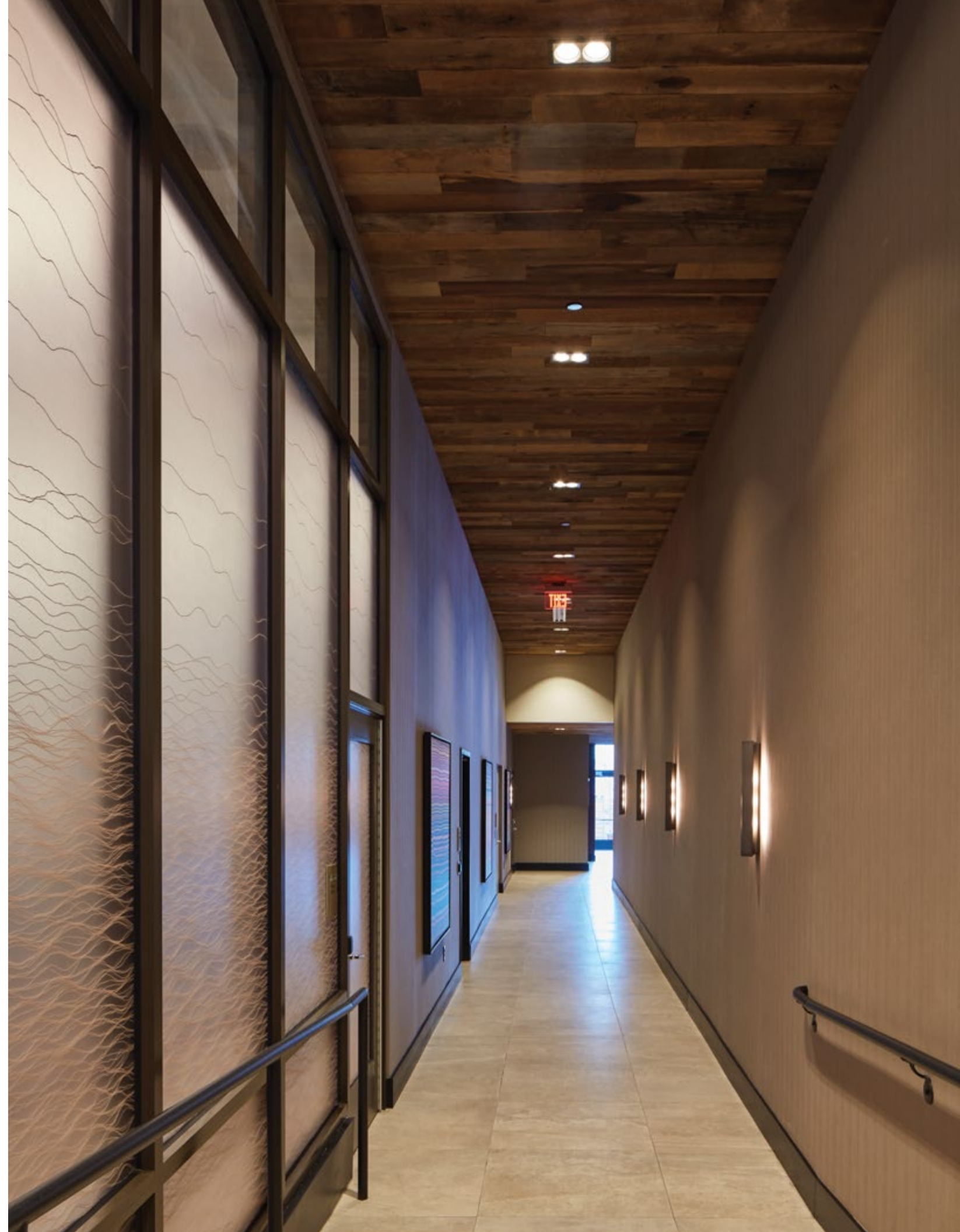
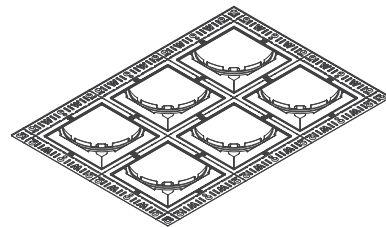



Future Proofing

The ProTools Downlight range is designed to allow complete flexibility of application, today, next month, next year, and beyond.

The modular design means that any combination of insert and cover can be fitted into the mounting frame, and at any time. For example, imagine an installation called for Wall Wash inserts and covers initially, but some years on the customer has a different requirement – adjustable downlights are now needed. No problem! Simply follow these few simple steps and the installation can be completely re-purposed, quickly and easily.

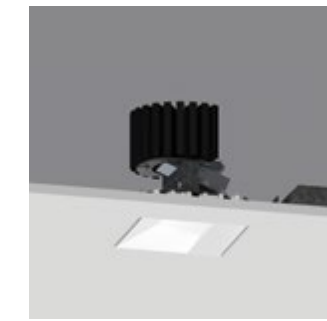

4" ProTools Wall Wash



4" ProTools Adjustable

- ① Insert the edge of the Aim Stick into the gap between the housing and the cover.

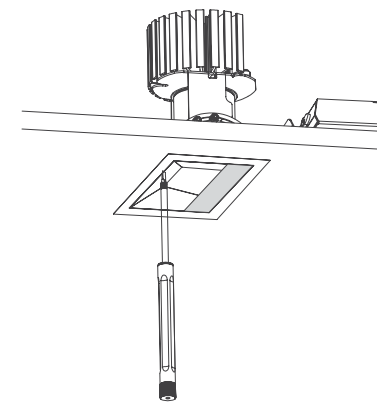

- ② Lever out the cover.

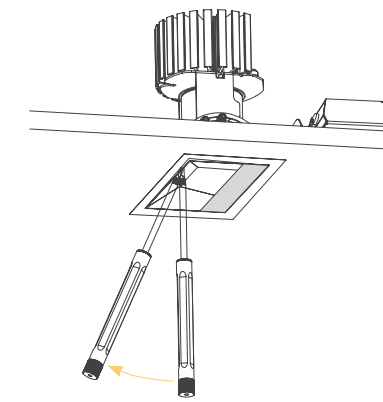

- ③ Remove the cover.

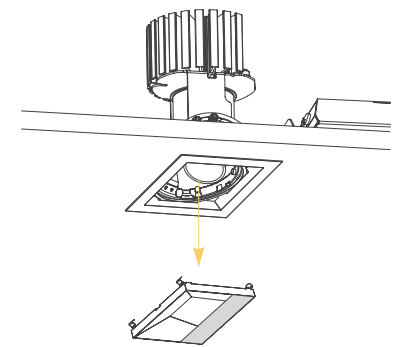

- ④ Remove Wall Wash insert and disconnect in-line connector (tool free) from driver / junction box.

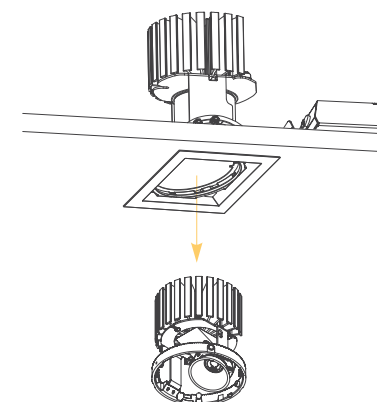

- ⑤ Connect replacement insert via inline connector (tool free) to driver / junction box, then snap into the housing.

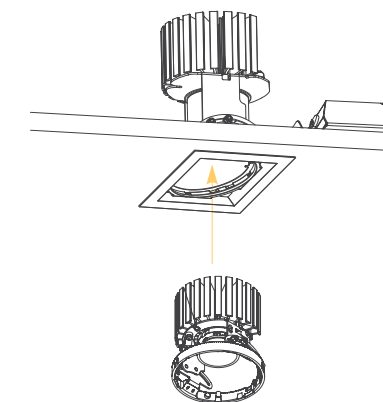

- ⑥ Fit new / preferred cover by simply snapping it home into the housing trim.

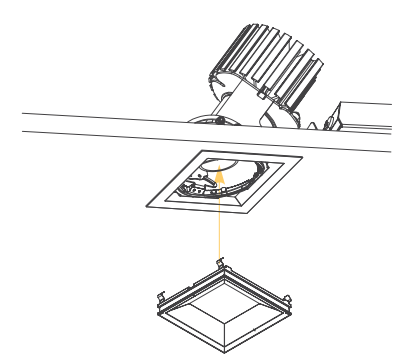



Application Guide

Whitegoods Downlights are extremely versatile and can be integrated in a multitude of ways to be applied to ambient downlighting and wall washing applications.

In the following pages, we explain the application intent and desired outcomes for downlighting, accent lighting and wall washing applications.

In short, Whitegoods luminaires and integration options allow the designer free reign when it comes to imagining innovative and fresh ways to breath light into a space.

You bring the vision to us, and we help you realize it.



Downlight Applications

Downlight

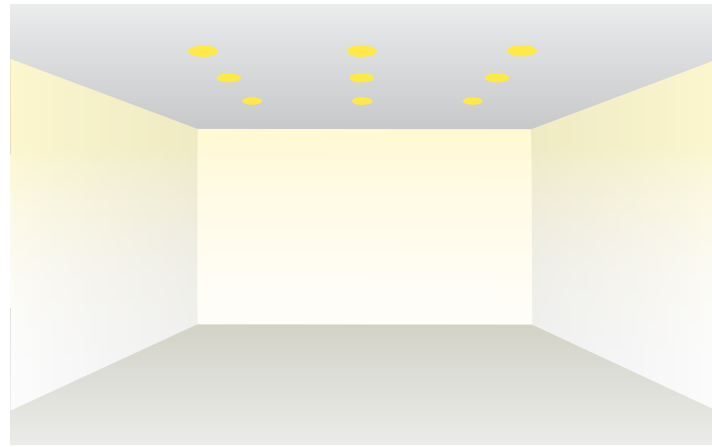

Perhaps the most common lighting solution utilized for general area lighting, arranging a group of lights in a grid to give even illumination to the surface below.

Of course, the popularity of a technique is not always a sign of best practice, and in this case it typically has more to do with economy and ease of implementation.

However, when applied to a space with some consideration it can be an effective technique. One thing to consider for this type of solution is "how much light will fall on the walls?". A space can have a lot of light being delivered into it, but if the walls are not sufficiently illuminated, there is a good chance that the space will feel gloomy, even though there is plenty of light falling on horizontal surfaces like desks or the floor.

Fortunately, many Whitegoods luminaires have good 'high angle distribution', which can help to deal with this common issue.

Adjustable

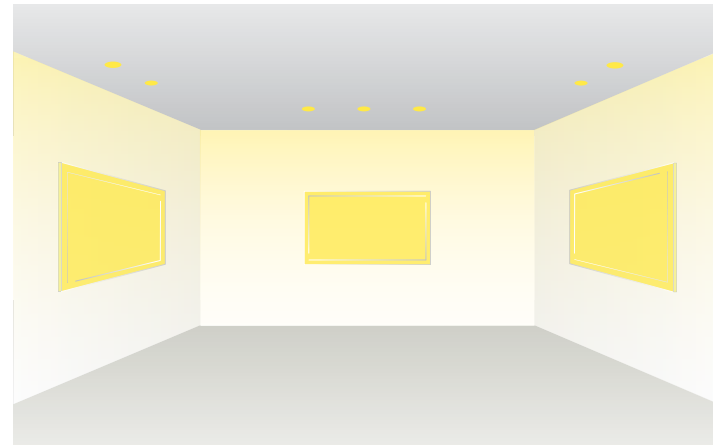

Of course, although considering whole surfaces is a highly effective way to start thinking about light within your project, it is equally possible to think in terms of specific pieces of architecture, art, sculpture, ornamentation or furniture, and treat these as focal objects, drawing the viewers attention to them naturally and simply by highlighting them against their background scenario.

A useful 'rule of thumb' here is that if you allow ten times more light to fall on an object relative to the surrounding light level, it will seem to be 'popping' out of the scene and will tend to draw the eye.

Washlight

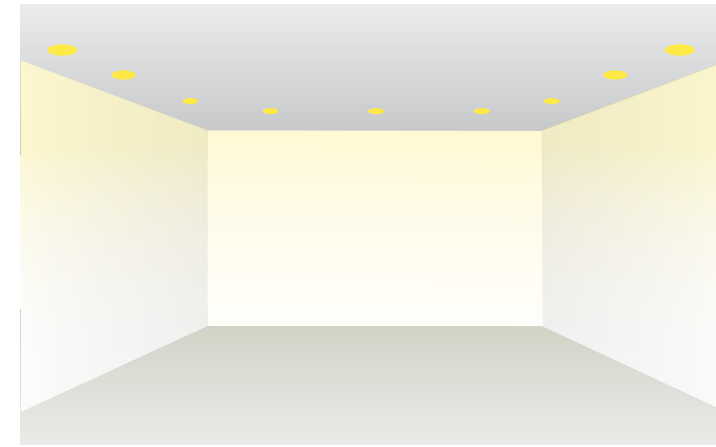

The aim of wall washing, or in fact washing any surface with light (wall, ceiling or floor), is to create an even 'wash' of light across the surface. The wall wash is a great way to introduce light into a room as the brightness of the vertical surfaces around us play a crucial role in our perception of a space. You can use linear or point sources, and both will need to emit a wide, even beam of light which is directed towards the wall, to create the effect.

Downlights need to be correctly positioned, both in terms of distance from the wall, and their relative distance to one another.

Multiple Luminaire Configurations / Wet Location

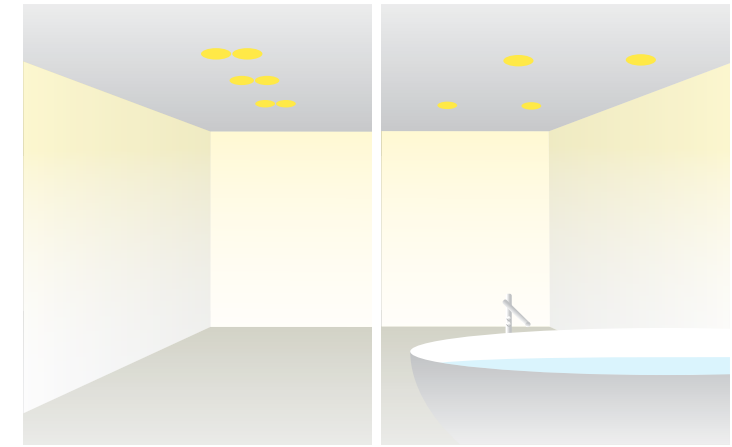

Multiple Luminaire Configurations

Multiple Luminaire Configurations can be accomplished using standard plastertrim downlight Frames.

With Protocols 3" and 4" Downlights you never have to purchase a specialized housing in order to realize a multiple configuration. In fact, you can simply snap off segments of the plaster-trim on standard product and field join the Frames during installation.

Wet Location

Most Whitegoods downlights are available in wet location for use outdoors as well as in showers and other applications where they may be exposed to moisture. Specialized silicon seal rings protect against moisture ingress, and are impervious to degradation caused by UV. See the specific product data sheet for availability on the specific model.

1.5" ProTools Downlights

1.5" ProTools Downlights family offers minimal size, high performance fixed or adjustable downlights and wall washers available in round or square and trimmed or trimless. The fixtures are designed to provide superb glare control and offer optional accessories to further control the beam. Whitegoods attention to seamless integration with surrounding materials is prevalent throughout the offering.

- Downlight
- Adjustable
- Wall Wash
- Suspended Cylinder
- Wet Location

Application guide
Product details

28-31
44-57





1.5" ProTools Range Logic

The ProTools range allows the specifier freedom to design for all spaces and environments within a project from one succinct, logical and aesthetically congruent range of luminaires. The comprehensive options cover all of the designer's needs.

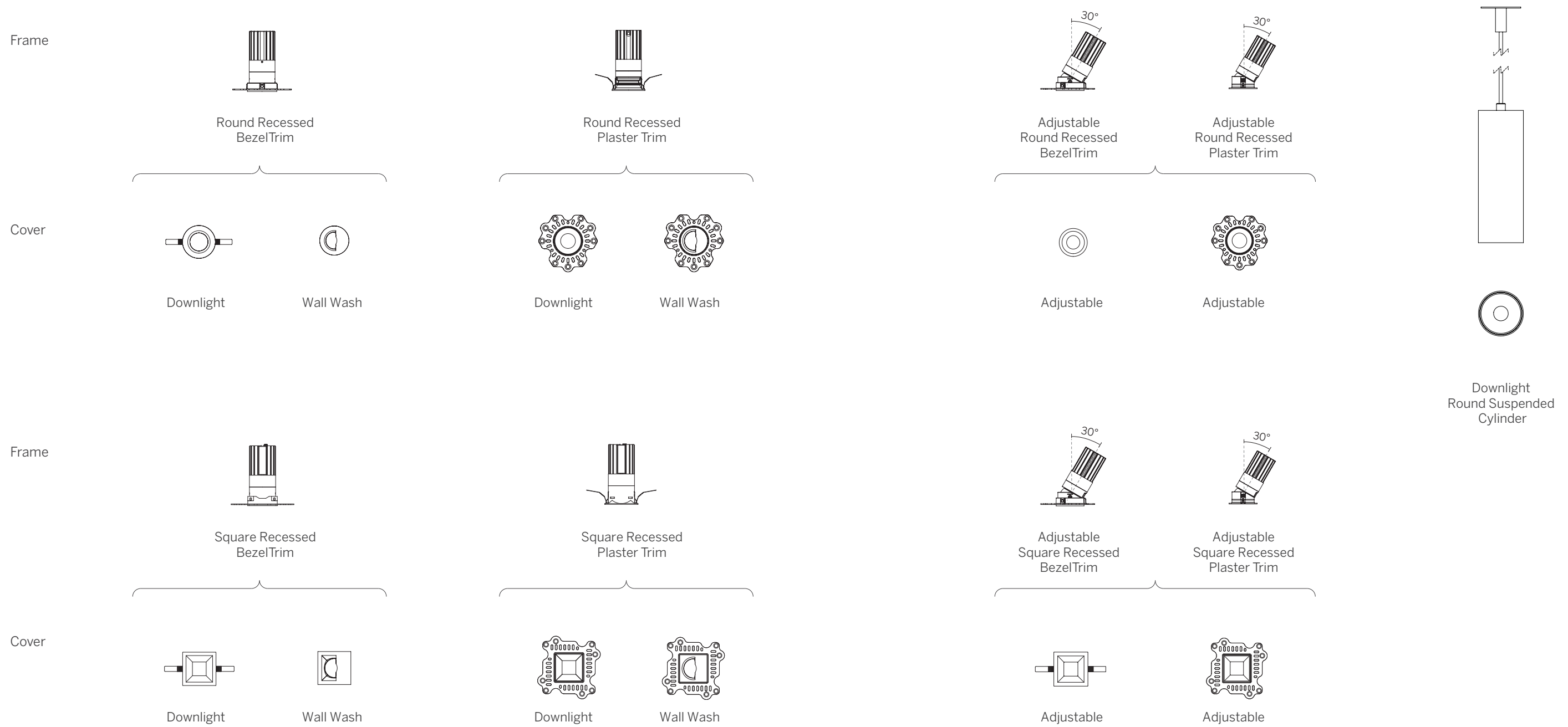

1.5" ProTools Twin Trim

Double headed fixtures can be accomplished with the use of our unique Twin Trim feature. Available with a rectangular faceplate or a recessed oval trim. Available for round downlight, adjustable and wallwash.

Rectangular Twin Trim with Bezel Trim (RTTBT)



Oval Twin Trim with Plaster Trim (OTTPT)

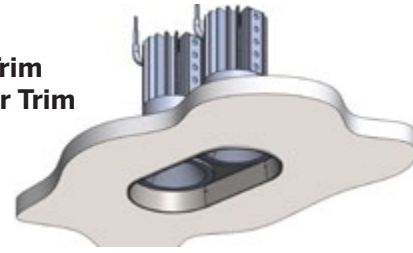

Oval Twin Trim with Wood Ceiling Trim (OTTWC)

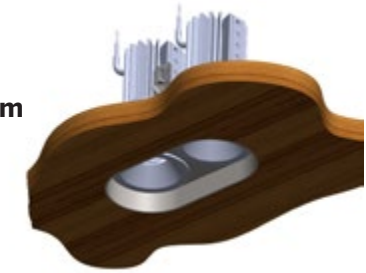

Downlight

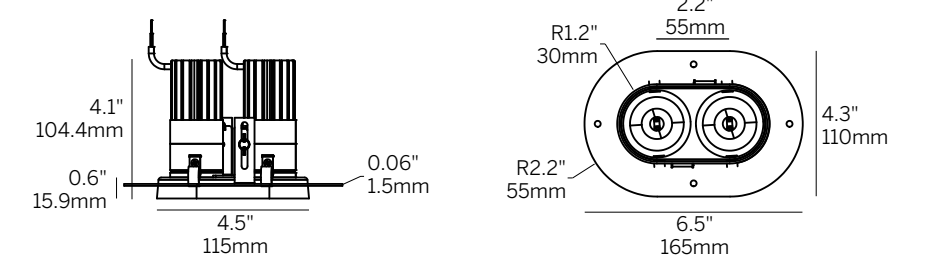
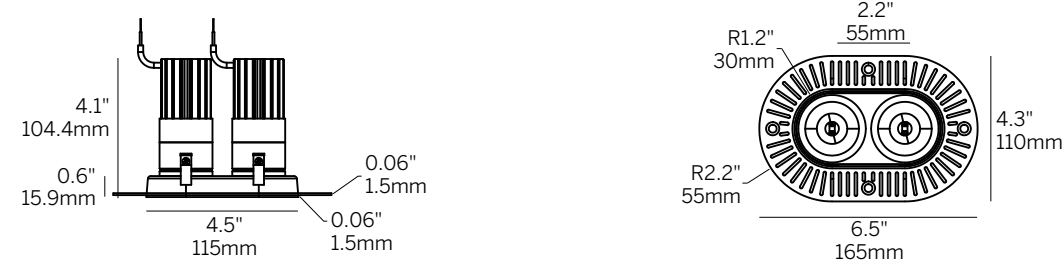
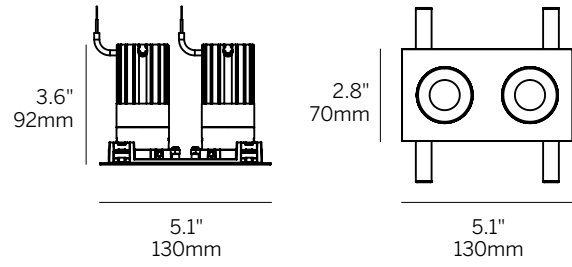

Adjustable

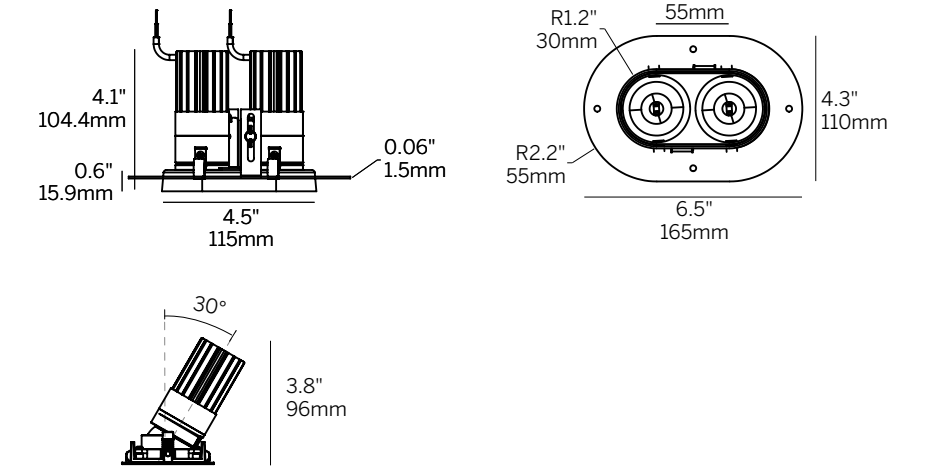
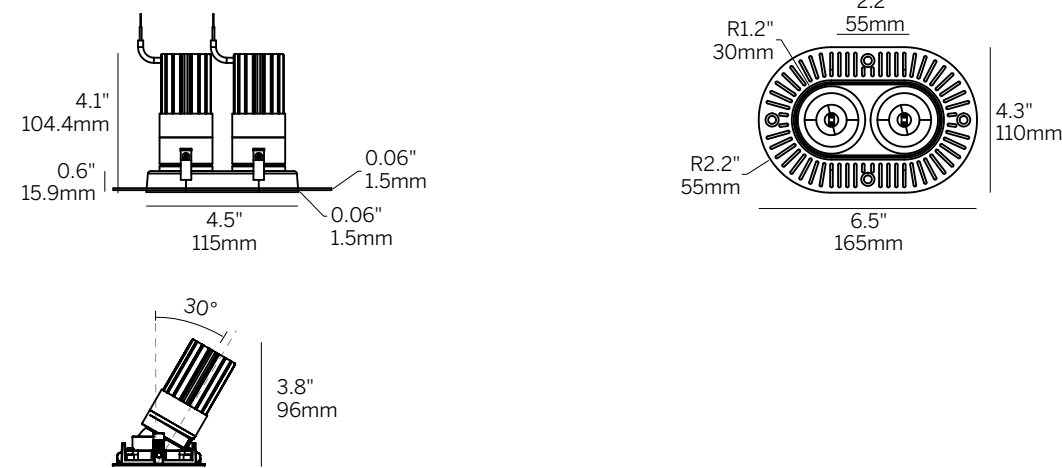
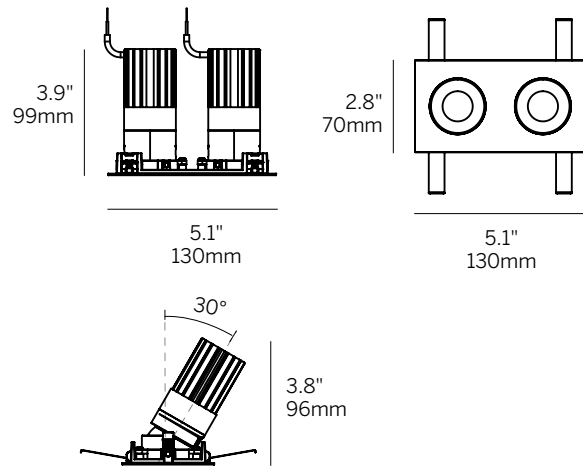

Wall Wash

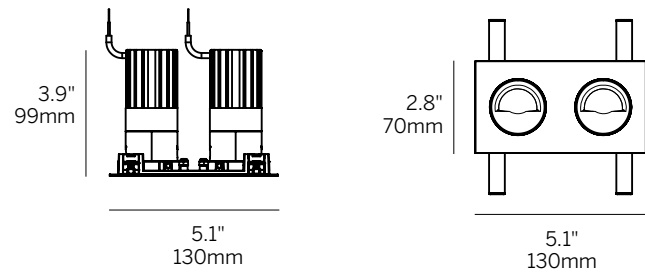

1.5" ProTools Downlights

A complete Family of 1.5" aperture downlights

- General illumination allows 6' spacing on 9' ceiling height for 15+FC maintained.
- Very small-aperture, low-brightness downlight for general and accent illumination.
- High-lumen output and excellent color rendition for all applications.
- Multiple housing styles for mounting into all ceiling types.
- Very shallow ceiling depth required for both integral and remote drivers.
- L70 (TM21 Projected 85°C) = Static White 33,300 hours Warm Dim 55,000 hours.
- Downlight UGR <16 meeting WELL Building criteria.

Fixed Downlights



1.5" ProTools Downlight Round Recessed

44



1.5" ProTools Downlight Square Recessed

46

Wall Wash



1.5" ProTools Wall Wash Round Recessed

52



1.5" ProTools Wall Wash Square Recessed

54

Adjustable Downlights



1.5" ProTools Adjustable Round Recessed

48



1.5" ProTools Adjustable Square Recessed

50

Suspended



1.5" ProTools Downlight Round Suspended Cylinder

56

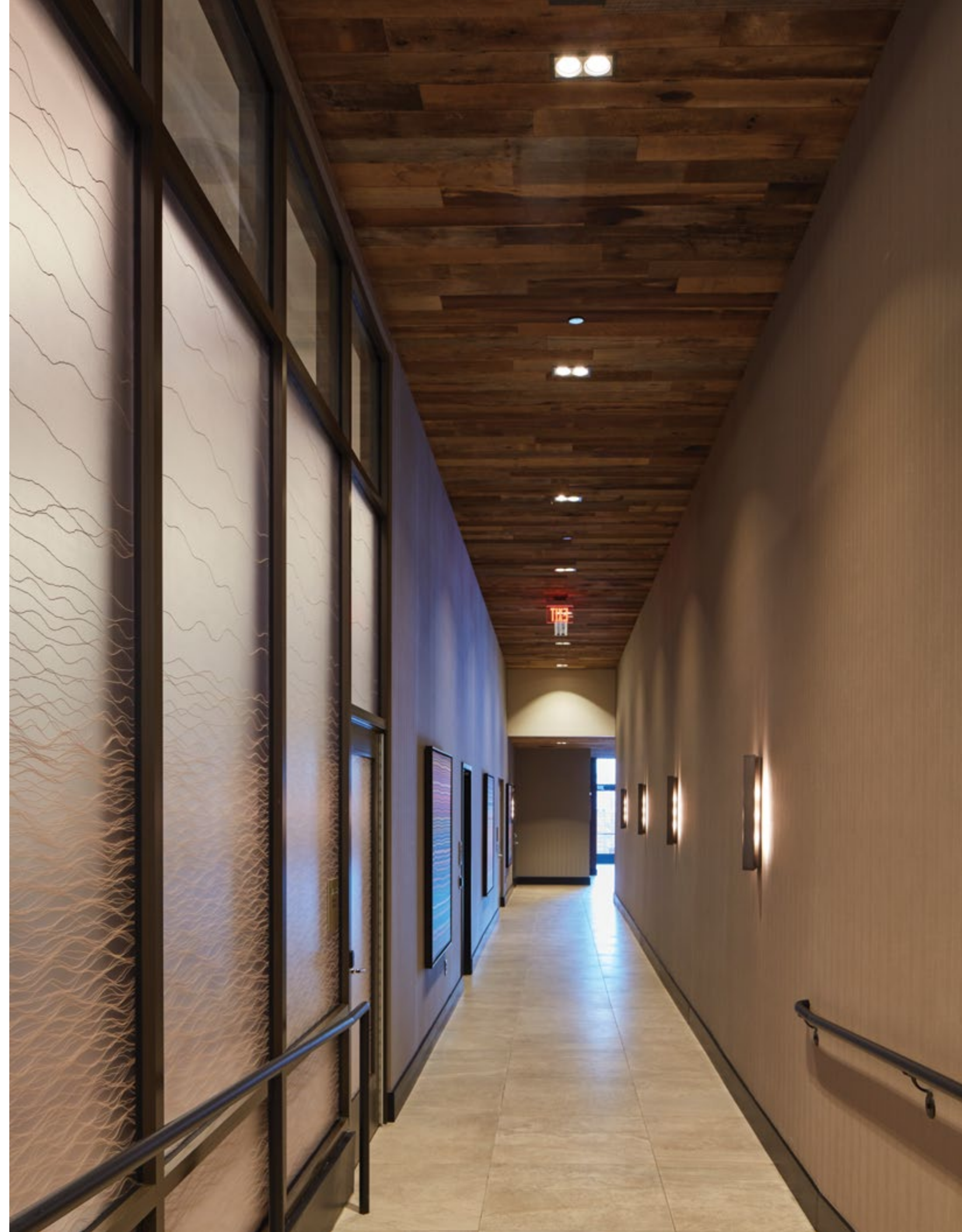



1.5" ProTools Downlight Round Recessed



1.5" round aperture recessed downlight with 0.9" light aperture recessed 0.5" from ceiling plane.

Luminaire	Die-caste aluminum for precision fit and heat dissipation Mounting hardware for all ceiling types; trim and trimless EZ clip mounting for secure installation
Cover	RRC - Round Recessed Cone for low brightness, general illumination with angled cone
LED	Constant Current, 92+ CRI (standard), 2-Step MacAdam Mid output (delivers up to 83 lumens per watt) 2700K, 3000K, 3500K, 4000K Warm Dim (1800 - 3000K) L70 (TM21 Projected 85° C) Static White = 33,300 hours, WD = 55,000 hours
Beam	20°, 25°, 35°, 50°
Driver	Integral and remote drivers for all dimming and non-dimming applications Non-Dim, 0-10V, Phase, Lutron, DALI driver options POE driver compatibility
Installation Housing	LP - Landing Pan NC - New Construction IC - Insulated Ceiling CP - Chicago Plenum X - No Housing (Optional)
Warranty	5-year Limited (see complete company warranty information)
Certifications	ETL and ETL-C for dry, damp (WL Wet Location optional), CE



Recessed Plaster Trim (RPT)



Recessed Bezel Trim (RBT)

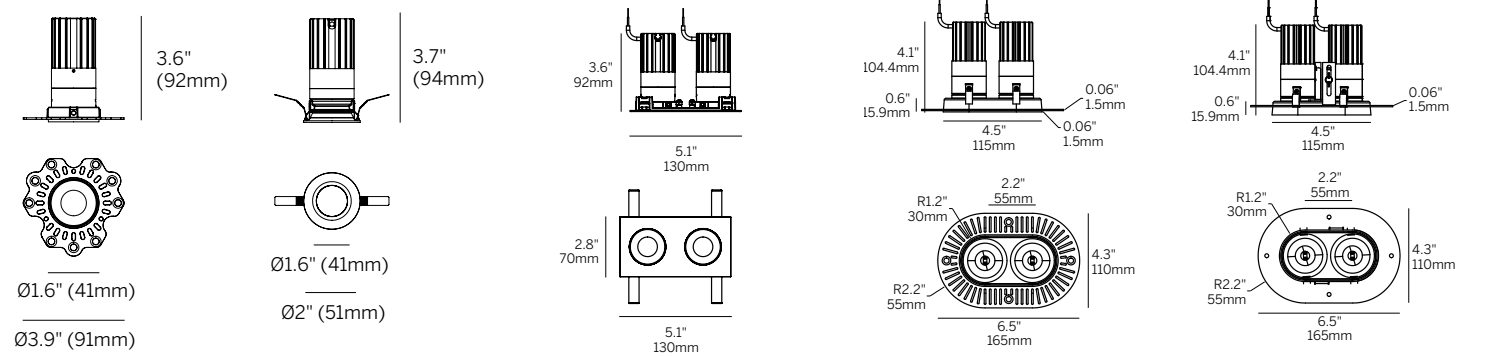

Plaster Trim (RPT)
Cutout: Ø2.1" (54mm)

Rectangular Twin Trim with Bezel Trim (RTTBT)
Cutout: 1.4" x 4.7" (60 x 120mm)

Oval Twin Trim with Plaster Trim (OTTPT)
Cutout: 1.4" x 4.7" (60 x 120mm)

Oval Twin Trim with Wood Ceiling Trim (OTTWC)
Cutout: 1.4" x 4.7" (60 x 120mm)

1.5" ProTools Downlight Round Recessed

Model	Fixation	Power ²	CRI	CCT ³	Driver ^{4,5}	Cover	Lens	Beam	Trim Finish	Housing ⁵	Options
WG-40RPTDL	RBT RPT RTTBT ¹ OTTPT ¹ OTTWC ¹	M	92	27 30 35 40 WD	S010* D010* SPH* PEQ0* D2S* X	RRC	OA ⁶ SOL ⁶ LSL ⁶ HL ⁶ DF	20 25 35 50	W (std) B S F	LP NC IC CP X	WL TM EM AWNRF

*Add 'R' for remote driver, ex. 'RS010'

Model

- WG-40RPTDL = 1.5" ProTools Downlight Round Recessed

Fixation

- RPT = Recessed Plaster Trim
- RBT = Recessed Bezel Trim
- RTTBT = Rectangular Twin Trim with Bezel Trim¹
- OTTPT = Oval Twin Trim with Plaster Trim¹
- OTTWC = Oval Twin Trim with Wood Ceiling Trim¹

Power²

- M = Mid Power, 9.1W @ 500mA

CRI

- 92 = 92 CRI

CCT³

- 27 = 2700K
- 30 = 3000K
- 35 = 3500K
- 40 = 4000K
- WD = Warm Dimming 1800 - 3000K

Integral Driver NC / IC / CP Housings Accessible Ceiling^{4,5}

- S010 = eldoLED 0-10V 1% dimming, 120-277V (22W)
- D010 = eldoLED 0-10V 0.1% dimming, 120-277V (22W)
- SPH = Phase (2-wire) 3% dimming, 120V only (20W)
- PEQ0 = Lutron Hi-Lume Premier 0.1% EcoSystem dimming, 120-277V (20W)
- D2S = DALI-2 (DT6) for Static White 0.1% dimming, 120-277V (22W)

Remote Driver for NC / LP / IC / CP^{4,5}

- RS010 = Remote eldoLED 0-10V 1% dimming, 120-277V (22W, 50W or 100W)
- RD010 = Remote eldoLED 0-10V 0.1% dimming, 120-277V (22W, 50W or 100W)
- RSPH = Remote phase (2-wire) 3% dimming, 120V only (20W)
- RPEQ0 = Remote Lutron Hi-Lume Premier 0.1% EcoSystem dimming, 120-277V (20W)
- RD2S = Remote DALI-2 (DT6) for Static White 0.1% dimming, 120-277V (22W, 50W or 100W)
- X = No Driver

Cover

- RRC = Round Recessed Cone

Lens

- OA = Open Aperture (clear lens provided standard)⁶
- SOL = Solite Lens⁶
- LSL = Linear Spread Lens⁶
- HL = Honeycomb Louver⁶
- DF = Diffusing Film

Beam

- 20 = 20° Beam Angle
- 25 = 25° Beam Angle
- 35 = 35° Beam Angle
- 50 = 50° Beam Angle

Trim Finish

- W = White, 15% gloss, RAL 9003 (standard)
- B = Black, 15% gloss, RAL 9005
- S = Silver, 15% gloss, RAL 9006
- F = Custom finish, specify RAL code

Housing (optional)⁵

- LP = Landing Pan (for remote driver)
- NC = New Construction Housing (integral driver for accessible ceilings only)
- IC = Insulated Ceiling Housing (integral driver for accessible ceilings only)
- CP = Chicago Plenum Housing (integral driver for accessible ceilings only)
- X = No Housing

Options

- WL = Wet Location
- TM = Thin Metal Ceiling Clip
- EM = Emergency [remote]
- AWNRF = Lutron Athena Wireless Node RF (RS010, RD010, RD2S drivers only)

Whitegoods reserves the right to change any information without prior notice.

Notes

- Twin Trim will be provided with 2 matching fixtures, unless specified otherwise. OTTWC can accommodate from 3/8 to 1 inch thick ceilings.
- Wattage shown does not include power supplies / drivers.
- See photometric data sheet for delivered lumens.
- See driver information for details.
- See housings pages for detail.
- One accessory per fixture.

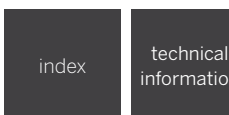

1.5" ProTools Downlight Square Recessed



1.5" square aperture recessed downlight with 0.8" square light aperture regressed 0.5" from ceiling plane.

Luminaire	Die-caste aluminum for precision fit and heat dissipation Mounting hardware for all ceiling types; trim and trimless EZ clip mounting for secure installation
Cover	SRC - Square Recessed Cone for low brightness, general illumination with angled cone
LED	Constant Current, 92+ CRI (standard), 2-Step MacAdam Mid output (delivers up to 83 lumens per watt) 2700K, 3000K, 3500K, 4000K Warm Dim (1800 - 3000K) L70 (TM21 Projected 85° C) Static White = 33,300 hours, WD = 55,000 hours
Beam	20°, 25°, 35°, 50°
Driver	Integral and remote drivers for all dimming and non-dimming applications Non-Dim, 0-10V, Phase, Lutron, DALI driver options POE driver compatibility
Installation Housing	LP - Landing Pan NC - New Construction IC - Insulated Ceiling CP - Chicago Plenum X - No Housing (Optional)
Warranty	5-year Limited (see complete company warranty information)
Certifications	ETL and ETL-C for dry, damp (WL Wet Location optional), CE



Recessed Plaster Trim (RPT)

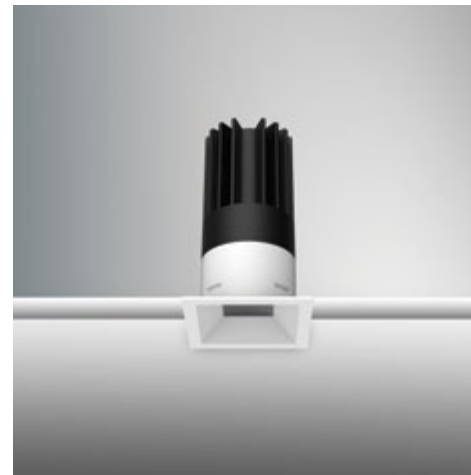

Recessed Bezel Trim (RBT)

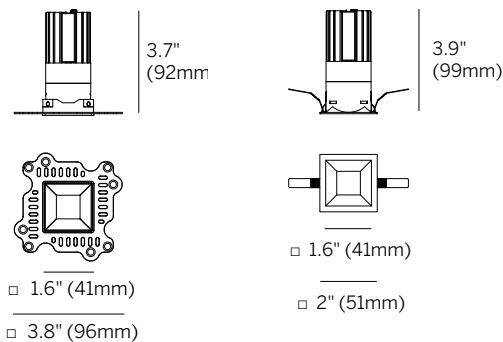

Plaster Trim (RPT)
Cutout: □ 2" (50mm)

Bezel Trim (RBT)
Cutout: □ 1.8" (46mm)

1.5" ProTools Downlight Square Recessed

Model	Fixation	Power ¹	CRI	CCT ²	Driver ^{3,4}	Cover	Lens	Beam	Trim Finish	Housing ⁴	Options
WG-40SPTDL	RBT RPT	M	92	27 30 35 40 WD	S010* D010* SPH* PEQ0* D2S* X	SRC	OA ⁵ SOL ⁵ LSL ⁵ HL ⁵ DF	20 25 35 50	W (std) B S F	LP NC IC CP X	WL TM EM AWNRF

*Add 'R' for remote driver, ex. 'RS2'

Model

- WG-40SPTDL = 1.5" ProTools Downlight Square Recessed

Fixation

- RPT = Recessed Plaster Trim
- RBT = Recessed Bezel Trim

Power¹

- M = Mid Power, 9.1W @ 500mA

CRI

- 92 = 92 CRI

CCT (Mid)²

- 27 = 2700K
- 30 = 3000K
- 35 = 3500K
- 40 = 4000K
- WD = Warm Dimming 1800 - 3000K

Integral Driver NC / IC / CP Housings Accessible Ceiling^{3,4}

- S010 = eldoLED 0-10V 1% dimming, 120-277V (22W)
- D010 = eldoLED 0-10V 0.1% dimming, 120-277V (22W)
- SPH = Phase (2-wire) 3% dimming, 120V only (20W)
- PEQ0 = Lutron Hi-Lume Premier 0.1% EcoSystem dimming, 120-277V (20W)
- D2S = DALI-2 (DT6) for Static White 0.1% dimming, 120-277V (22W)

Remote Driver for NC / LP / IC / CP^{3,4}

- RS010 = Remote eldoLED 0-10V 1% dimming, 120-277V (22W, 50W or 100W)
- RD010 = Remote eldoLED 0-10V 0.1% dimming, 120-277V (22W, 50W or 100W)
- RSPH = Remote phase (2-wire) 3% dimming, 120V only (20W)
- RPEQ0 = Remote Lutron Hi-Lume Premier 0.1% EcoSystem dimming, 120-277V (20W)
- RD2S = Remote DALI-2 (DT6) for Static White 0.1% dimming, 120-277V (22W, 50W or 100W)
- X = No Driver

Cover

- SRC = Square Recessed Cone

Lens

- OA = Open Aperture (clear lens provided standard)⁵
- SOL = Solite Lens⁵
- LSL = Linear Spread Lens⁵
- HL = Honeycomb Louver⁵
- DF = Diffusing Film

Beam

- 20 = 20° Beam Angle
- 25 = 25° Beam Angle
- 35 = 35° Beam Angle
- 50 = 50° Beam Angle

Trim Finish

- W = White, 15% gloss, RAL 9003 (standard)
- B = Black, 15% gloss, RAL 9005
- S = Silver, 15% gloss, RAL 9006
- F = Custom finish, specify RAL code

Housing (optional)⁴

- LP = Landing Pan (for remote driver)
- NC = New Construction Housing (integral driver for accessible ceilings only)
- IC = Insulated Ceiling Housing (integral driver for accessible ceilings only)
- CP = Chicago Plenum Housing (integral driver for accessible ceilings only)
- X = No Housing

Options

- WL = Wet Location
- TM = Thin Metal Ceiling Clip
- EM = Emergency (remote only)
- AWNRF = Lutron Athena Wireless Node RF (RS010, RD010, RD2S drivers only)

Whitegoods reserves the right to change any information without prior notice.

Notes

- Wattage shown does not include power supplies / drivers.
- See photometric data sheet for delivered lumens.
- See driver information page for details.
- See housings pages for detail.
- One accessory per fixture.

index

technical
information



1.5" ProTools Adjustable Round Recessed



1.5" round aperture recessed downlight with 0.9" light aperture regressed 0.5" from ceiling plane.

Luminaire	Die-caste aluminum for precision fit and heat dissipation Mounting hardware for all ceiling types; trim and trimless EZ clip mounting for secure installation
Cover	RRC - Round Recessed Cone for low brightness, general illumination with angled cone
LED	Constant Current, 92+ CRI (standard), 2-Step MacAdam Mid output (delivers up to 83 lumens per watt) 2700K, 3000K, 3500K, 4000K Warm Dim (1800 - 3000K) L70 (TM21 Projected 85° C) Static White = 33,300 hours, WD = 55,000 hours
Beam	20°, 25°, 35°, 50°
Driver	Integral and remote drivers for all dimming and non-dimming applications Non-Dim, 0-10V, Phase, Lutron, DALI driver options POE driver compatibility
Installation Housing	LP - Landing Pan NC - New Construction IC - Insulated Ceiling CP - Chicago Plenum X - No Housing (Optional)
Warranty	5-year Limited (see complete company warranty information)
Certifications	ETL and ETL-C for dry and damp location, CE

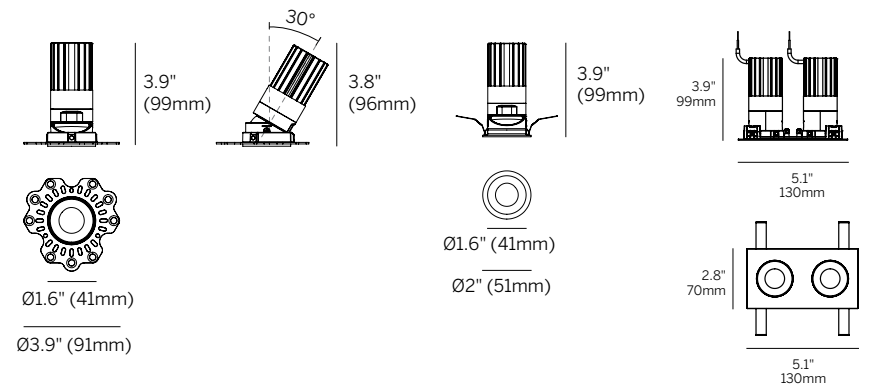

Plaster Trim (RPT)
Cutout: □ 2.1" (50mm)

Bezel Trim (RBT)
Cutout: □ 1.8" (45mm)

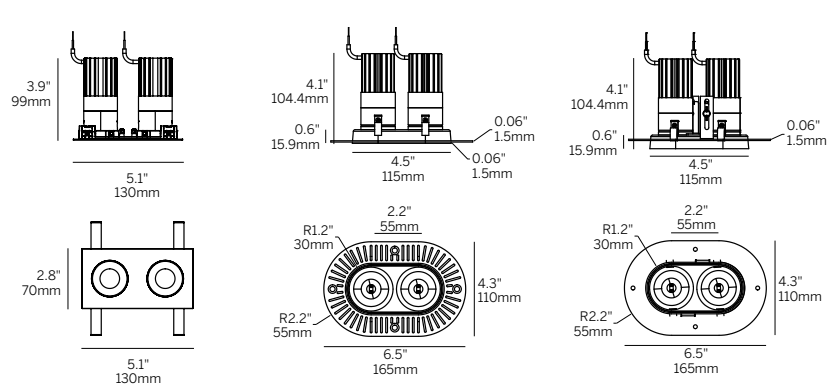

Rectangular Twin Trim with Bezel Trim (RTTBT)
Cutout: 1.4" x 4.7"
(60 x 120mm)

Oval Twin Trim with Plaster Trim (OTTPT)
Cutout: 4.625" x 2.5"
(117.5 x 63.5mm)
Arc Radius 1.25" (31.8mm)

Oval Twin Trim with Wood Ceiling Trim (OTTWC)
Cutout: 4.53" x 2.365"
(115.1 x 60.1mm)
Arc Radius 1.183" (30mm)

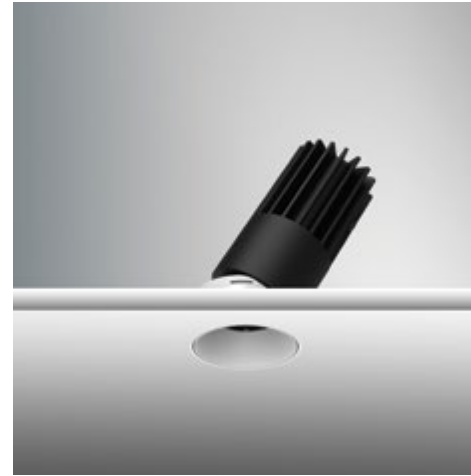

Recessed Plaster Trim (RPT)



Recessed Bezel Trim (RBT)

1.5" ProTools Adjustable Round Recessed

Model	Fixation	Power ²	CRI	CCT ³	Driver ^{4,5}	Cover	Lens	Beam	Trim Finish	Housing ⁵	Options
WG-40RPTA	RBT RPT RTTBT ¹ OTTPT ¹ OTTWC ¹	M	92	27 30 35 40 WD	S010* D010* SPH* PEQ0* D2S* X	RRC	OA ⁶ SOL ⁶ LSL ⁶ HL ⁶ DF	20 25 35 50	W (std) B S F	LP NC IC CP X	TM EM AWNRF

*Add 'R' for remote driver, ex. 'RS010'

Model

- WG-40RPTA = 1.5" ProTools Adjustable Round Recessed

Fixation

- RPT = Recessed Plaster Trim
- RBT = Recessed Bezel Trim
- RTTBT = Rectangular Twin Trim with Bezel Trim¹
- OTTPT = Oval Twin Trim with Plaster Trim¹
- OTTWC = Oval Twin Trim with Wood Ceiling Trim¹

Power²

- M = Mid Power, 9.1W @ 500mA

CRI

- 92 = 92 CRI

CCT³

- 27 = 2700K
- 30 = 3000K
- 35 = 3500K
- 40 = 4000K
- WD = Warm Dimming 1800 - 3000K

Integral Driver NC / IC / CP Housings Accessible Ceiling^{4,5}

- S010 = eldoLED 0-10V 1% dimming, 120-277V (22W)
- D010 = eldoLED 0-10V 0.1% dimming, 120-277V (22W)
- SPH = Phase (2-wire) 3% dimming, 120V only (20W)
- PEQ0 = Lutron Hi-Lume Premier 0.1% EcoSystem dimming, 120-277V (20W)
- D2S = DALI-2 (DT6) for Static White 0.1% dimming, 120-277V (22W)

Remote Driver for NC / LP / IC / CP^{4,5}

- RS010 = Remote eldoLED 0-10V 1% dimming, 120-277V (22W, 50W or 100W)
- RD010 = Remote eldoLED 0-10V 0.1% dimming, 120-277V (22W, 50W or 100W)
- RSPH = Remote phase (2-wire) 3% dimming, 120V only (20W)
- RPEQ0 = Remote Lutron Hi-Lume Premier 0.1% EcoSystem dimming, 120-277V (20W)
- RD2S = Remote DALI-2 (DT6) for Static White 0.1% dimming, 120-277V (22W, 50W or 100W)
- X = No Driver

Whitegoods reserves the right to change any information without prior notice.

Notes

- Twin Trim will be provided with 2 matching fixtures, unless specified otherwise. OTTWC can accommodate from 3/8 to 1 inch thick ceilings.
- Wattage shown does not include power supplies / drivers.
- See photometric data sheet for delivered lumens.
- See driver information for details.
- See housings pages for details.
- One accessory per fixture.

Cover

- RRC = Round Recessed Cone

Lens

- OA = Open Aperture (clear lens provided standard)⁶
- SOL = Solite Lens⁶
- LSL = Linear Spread Lens⁶
- HL = Honeycomb Louver⁶
- DF = Diffusing Film

Beam

- 20 = 20° Beam Angle
- 25 = 25° Beam Angle
- 35 = 35° Beam Angle
- 50 = 50° Beam Angle

Trim Finish

- W = White, 15% gloss, RAL 9003 (standard)
- B = Black, 15% gloss, RAL 9005
- S = Silver, 15% gloss, RAL 9006
- F = Custom finish, specify RAL code

Housing (optional)⁵

- LP = Landing Pan (for remote driver)
- NC = New Construction Housing (integral driver for accessible ceilings only)
- IC = Insulated Ceiling Housing (integral driver for accessible ceilings only)
- CP = Chicago Plenum Housing (integral driver for accessible ceilings only)
- X = No Housing

Options

- TM = Thin Metal Ceiling Clip
- EM = Emergency (remote only)
- AWNRF = Lutron Athena Wireless Node RF (RS010, RD010, RD2S drivers only)

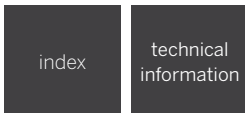

1.5" ProTools Adjustable Square Recessed



1.5" square aperture recessed downlight with 0.8" light aperture regressed 0.3" from ceiling plane.

Luminaire	Die-caste aluminum for precision fit and heat dissipation Mounting hardware for all ceiling types; trim and trimless EZ clip mounting for secure installation
Cover	SRC - Square Recessed Cone for low brightness, general illumination with angled cone
LED	Constant Current, 92+ CRI (standard), 2-Step MacAdam Mid output (delivers up to 79 lumens per watt) 2700K, 3000K, 3500K, 4000K Warm Dim (1800 - 3000K) L70 (TM21 Projected 85° C) Static White = 33,300 hours, WD = 55,000 hours
Beam	20°, 25°, 35°, 50°
Driver	Integral and remote drivers for all dimming and non-dimming applications Non-Dim, 0-10V, Phase, Lutron, DALI driver options POE driver compatibility
Installation Housing	LP - Landing Pan NC - New Construction IC - Insulated Ceiling CP - Chicago Plenum X - No Housing (Optional)
Warranty	5-year Limited (see complete company warranty information)
Certifications	ETL and ETL-C for dry and damp location, CE

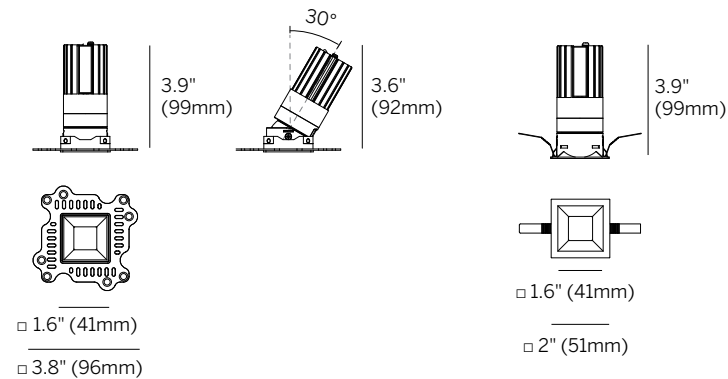

Plaster Trim (RPT)
Cutout: □ 2" (50mm)

Bezel Trim (RBT)
Cutout: □ 1.8" (46mm)



Recessed Plaster Trim (RPT)



Recessed Bezel Trim (RBT)

1.5" ProTools Adjustable Square Recessed

Model	Fixation	Power ¹	CRI	CCT ²	Driver ^{3,4}	Cover	Lens	Beam	Trim Finish	Housing ⁴	Options
WG-40SPTA	RBT RPT	M	92	27 30 35 40 WD	S010* D010* SPH* PEQ0* D2S* X	SRC	OA ⁵ SOL ⁵ LSL ⁵ HL ⁵ DF	20 25 35 50	W (std) B S F	LP NC IC CP X	TM EM AWNRF

*Add 'R' for remote driver, ex. 'RS010'

Model

- WG-40SPTA = 1.5" ProTools Adjustable Square Recessed

Fixation

- RPT = Recessed Plaster Trim
- RBT = Recessed Bezel Trim

Power¹

- M = Mid Power, 9.1W @ 500mA

CRI

- 92 = 92 CRI

CCT²

- 27 = 2700K
- 30 = 3000K
- 35 = 3500K
- 40 = 4000K
- WD = Warm Dimming 1800 - 3000K

Integral Driver NC / IC / CP Housings Accessible Ceiling^{3,4}

- S010 = eldoLED 0-10V 1% dimming, 120-277V (22W)
- D010 = eldoLED 0-10V 0.1% dimming, 120-277V (22W)
- SPH = Phase (2-wire) 3% dimming, 120V only (20W)
- PEQ0 = Lutron Hi-Lume Premier 0.1% EcoSystem dimming, 120-277V (20W)
- D2S = DALI-2 (DT6) for Static White 0.1% dimming, 120-277V (22W)

Remote Driver for NC / LP / IC / CP^{3,4}

- RS010 = Remote eldoLED 0-10V 1% dimming, 120-277V (22W, 50W or 100W)
- RD010 = Remote eldoLED 0-10V 0.1% dimming, 120-277V (22W, 50W or 100W)
- RSPH = Remote phase (2-wire) 3% dimming, 120V only (20W)
- RPEQ0 = Remote Lutron Hi-Lume Premier 0.1% EcoSystem dimming, 120-277V (20W)
- RD2S = Remote DALI-2 (DT6) for Static White 0.1% dimming, 120-277V (22W, 50W or 100W)
- X = No Driver

Cover

- SRC = Square Recessed Cone

Lens

- OA = Open Aperture (clear lens provided standard)⁵
- SOL = Solite Lens⁵
- LSL = Linear Spread Lens⁵
- HL = Honeycomb Louver⁵
- DF = Diffusing Film

Beam

- 20 = 20° Beam Angle
- 25 = 25° Beam Angle
- 35 = 35° Beam Angle
- 50 = 50° Beam Angle

Trim Finish

- W = White, 15% gloss, RAL 9003 (standard)
- B = Black, 15% gloss, RAL 9005
- S = Silver, 15% gloss, RAL 9006
- F = Custom finish, specify RAL code

Housing (optional)⁴

- LP = Landing Pan (for remote driver)
- NC = New Construction Housing (integral driver for accessible ceilings only)
- IC = Insulated Ceiling Housing (integral driver for accessible ceilings only)
- CP = Chicago Plenum Housing (integral driver for accessible ceilings only)
- X = No Housing

Options

- TM = Thin Metal Ceiling Clip
- EM = Emergency (remote only)
- AWNRF = Lutron Athena Wireless Node RF (RS010, RD010, RD2S drivers only)

Whitegoods reserves the right to change any information without prior notice.

Notes

- Wattage shown does not include power supplies / drivers.
- See photometric data sheet for delivered lumens.
- See driver information page for details.
- See housings pages for details.
- One accessory per fixture.

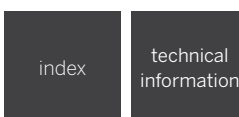

1.5" ProTools Wall Wash Round Recessed



1.5" round aperture recessed wall wash with 1.4" half moon light aperture and internal reflector system.

Luminaire	Die-caste aluminum for precision fit and heat dissipation Mounting hardware for all ceiling types; trim and trimless EZ clip mounting for secure installation
Cover	RWW - Round Wall Wash with flush room-side cutoff and internal scoop reflector
LED	Constant Current, 92+ CRI (standard), 2-Step MacAdam Mid output (delivers up to 47 lumens per watt) 2700K, 3000K, 3500K, 4000K Warm Dim (1800 - 3000K) L70 (TM21 Projected 85° C) Static White = 33,300 hours, WD = 55,000 hours
Beam	Wall Wash
Driver	Integral and remote drivers for all dimming and non-dimming applications Non-Dim, 0-10V, Phase, Lutron, DALI driver options POE driver compatibility
Installation Housing	LP - Landing Pan NC - New Construction IC - Insulated Ceiling CP - Chicago Plenum X - No Housing (Optional)
Warranty	5-year Limited (see complete company warranty information)
Certifications	ETL and ETL-C for dry, damp (WL Wet Location optional), CE

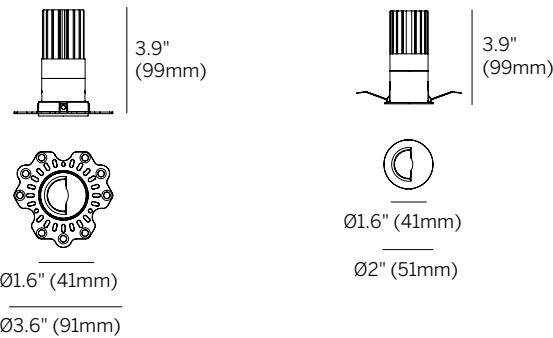

Plaster Trim (RPT)
Cutout: Ø2.1" (54mm)

Bezel Trim (RBT)
Cutout: Ø1.8" (45mm)

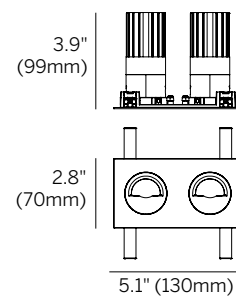

Rectangular Twin Trim with Bezel Trim (RTTBT)
Cutout: 1.4" x 4.7" (60 x 120mm)



Recessed Plaster Trim (RPT)



Recessed Bezel Trim (RBT)

1.5" ProTools Wall Wash Round Recessed

Model	Fixation	Power ²	CRI	CCT ³	Driver ^{4,5}	Cover	Lens	Beam	Trim Finish	Housing ⁵	Options
WG-40RPTWW	RBT RPT RTTBT ¹	M	92	27 30 35 40 WD	S010* D010* SPH* PEQ0* D2S* X	RWW	WWL	WW	W (std) B S F	LP NC IC CP X	WL TM EM AWNRF

*Add 'R' for remote driver, ex. 'RS010'

Model

- WG-40RPTWW = 1.5" ProTools Wall Wash Round Recessed

Fixation

- RPT = Recessed Plaster Trim
- RBT = Recessed Bezel Trim
- RTTBT = Rectangular Twin Trim with Bezel Trim¹

Power²

- M = Mid Power, 9.1W @ 500mA

CRI

- 92 = 92 CRI

CCT³

- 27 = 2700K
- 30 = 3000K
- 35 = 3500K
- 40 = 4000K
- WD = Warm Dimming 1800 - 3000K

Integral Driver NC / IC / CP Housings Accessible Ceiling^{4,5}

- S010 = eldoLED 0-10V 1% dimming, 120-277V (22W)
- D010 = eldoLED 0-10V 0.1% dimming, 120-277V (22W)
- SPH = Phase (2-wire) 3% dimming, 120V only (20W)
- PEQ0 = Lutron Hi-Lume Premier 0.1% EcoSystem dimming, 120-277V (20W)
- D2S = DALI-2 (DT6) for Static White 0.1% dimming, 120-277V (22W)

Remote Driver for NC / LP / IC / CP^{4,5}

- RS010 = Remote eldoLED 0-10V 1% dimming, 120-277V (22W, 50W or 100W)
- RD010 = Remote eldoLED 0-10V 0.1% dimming, 120-277V (22W, 50W or 100W)
- RSPH = Remote phase (2-wire) 3% dimming, 120V only (20W)
- RPEQ0 = Remote Lutron Hi-Lume Premier 0.1% EcoSystem dimming, 120-277V (20W)
- RD2S = Remote DALI-2 (DT6) for Static White 0.1% dimming, 120-277V (22W, 50W or 100W)
- X = No Driver

Cover

- RWW = Round Wall Wash

Lens

- WWL = Wall Wash Spread Lens

Beam

- WW = Wall Wash

Trim Finish

- W = White, 15% gloss, RAL 9003 (standard)
- B = Black, 15% gloss, RAL 9005
- S = Silver, 15% gloss, RAL 9006
- F = Custom finish, specify RAL code

Housing (optional)⁵

- LP = Landing Pan (for remote driver)
- NC = New Construction Housing (integral driver for accessible ceilings only)
- IC = Insulated Ceiling Housing (integral driver for accessible ceilings only)
- CP = Chicago Plenum Housing (integral driver for accessible ceilings only)
- X = No Housing

Options

- WL = Wet location
- TM = Thin Metal Ceiling Clip
- EM = Emergency (remote only)
- AWNRF = Lutron Athena Wireless Node RF (RS010, RD010, RD2S drivers only)

Whitegoods reserves the right to change any information without prior notice.

Notes

1. TT Twin Trim will be provided with (2) matching fixtures, unless specified otherwise.
2. Wattage shown is for LED only, system wattage varies depending on driver selected.
3. See photometric data sheet for delivered lumens.
4. See driver information for details.
5. Refer to Housings detail page for additional information.
6. Fixture can be installed without housing.

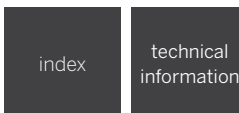

1.5" ProTools Wall Wash Square Recessed



1.5" square aperture recessed wall wash with 1.4" half moon light aperture and internal reflector system.

Luminaire	Die-caste aluminum for precision fit and heat dissipation Mounting hardware for all ceiling types; trim and trimless EZ clip mounting for secure installation
Cover	SWW - Square Wall Wash with flush room-side cutoff and internal scoop reflector
LED	Constant Current, 92+ CRI (standard), 2-Step MacAdam Mid output (delivers up to 47 lumens per watt) 2700K, 3000K, 3500K, 4000K Warm Dim (1800 - 3000K) L70 (TM21 Projected 85° C) Static White = 33,300 hours, WD = 55,000 hours
Beam	Wall Wash
Driver	Integral and remote drivers for all dimming and non-dimming applications Non-Dim, 0-10V, Phase, Lutron, DALI driver options POE driver compatibility
Installation Housing	LP - Landing Pan NC - New Construction IC - Insulated Ceiling CP - Chicago Plenum X - No Housing (Optional)
Warranty	5-year Limited (see complete company warranty information)
Certifications	ETL and ETL-C for dry, damp (WL Wet Location optional), CE

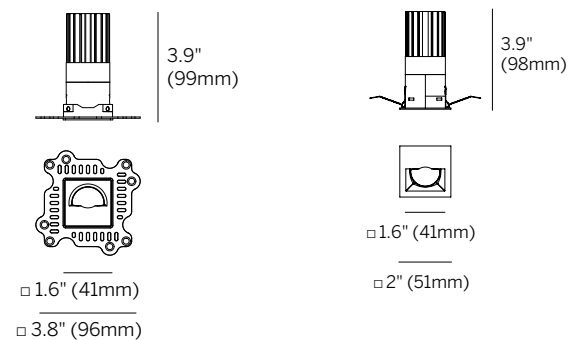

Plaster Trim (RPT)
Cutout: □ 2" (50mm)

Bezel Trim (RBT)
Cutout: □ 1.8" (46mm)



Recessed Plaster Trim (RPT)



Recessed Bezel Trim (RBT)

1.5" ProTools Wall Wash Square Recessed

Model	Fixation	Power ¹	CRI	CCT ²	Driver ^{3,4}	Cover	Lens	Beam	Trim Finish	Housing ⁴	Options
WG-40SPTWW	RBT RPT	M	92	27 30 35 40 WD	S010* D010* SPH* PEQ0* D2S* X	SWW	WWL	WW	W (std) B S F	LP NC IC CP X	WL TM EM AWNRF

*Add 'R' for remote driver, ex. 'RS010'

Model

- WG-40SPTWW = 1.5" ProTools Wall Wash Square Recessed

Fixation

- RPT = Recessed Plaster Trim
- RBT = Recessed Bezel Trim

Power¹

- M = Mid Power, 9.1W @ 500mA

CRI

- 92 = 92 CRI

CCT²

- 27 = 2700K
- 30 = 3000K
- 35 = 3500K
- 40 = 4000K
- WD = Warm Dimming 1800 - 3000K

Integral Driver NC / IC / CP Housings

Accessible Ceiling^{3,4}

- S010 = eldoLED 0-10V 1% dimming, 120-277V (22W)
- D010 = eldoLED 0-10V 0.1% dimming, 120-277V (22W)
- SPH = Phase (2-wire) 3% dimming, 120V only (20W)
- PEQ0 = Lutron Hi-Lume Premier 0.1% EcoSystem dimming, 120-277V (20W)
- D2S = DALI-2 (DT6) for Static White 0.1% dimming, 120-277V (22W)

Remote Driver for NC / LP / IC / CP^{3,4}

- RS010 = Remote eldoLED 0-10V 1% dimming, 120-277V (22W, 50W or 100W)
- RD010 = Remote eldoLED 0-10V 0.1% dimming, 120-277V (22W, 50W or 100W)
- RSPH = Remote phase (2-wire) 3% dimming, 120V only (20W)
- RPEQ0 = Remote Lutron Hi-Lume Premier 0.1% EcoSystem dimming, 120-277V (20W)
- RD2S = Remote DALI-2 (DT6) for Static White 0.1% dimming, 120-277V (22W, 50W or 100W)
- X = No Driver

Cover

- SWW = Square Wall Wash

Lens

- WWL = Wall Wash Spread Lens

Beam

- WW = Wall Wash

Trim Finish

- W = White, 15% gloss, RAL 9003 (standard)
- B = Black, 15% gloss, RAL 9005
- S = Silver, 15% gloss, RAL 9006
- F = Custom finish, specify RAL code

Housing (optional)⁴

- LP = Landing Pan (for remote driver)
- NC = New Construction Housing (integral driver for accessible ceilings only)
- IC = Insulated Ceiling Housing (integral driver for accessible ceilings only)
- CP = Chicago Plenum Housing (integral driver for accessible ceilings only)
- X = No Housing

Options

- WL = Wet location
- TM = Thin Metal Ceiling Clip
- EM = Emergency (remote only)
- AWNRF = Lutron Athena Wireless Node RF (RS010, RD010, RD2S drivers only)

Whitegoods reserves the right to change any information without prior notice.

Notes

1. Wattage shown does not include power supplies / drivers.
2. See photometric data sheet for delivered lumens.
3. See driver information page for details.
4. See housings pages for details.

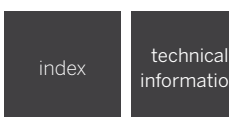

1.5" ProTools Downlight Round Suspended Cylinder



2" diameter suspended cylinder downlight with 1.5" round aperture with 0.8" light aperture regressed 0.5" from bottom of fixture.

Luminaire	Die-caste aluminum for precision fit and heat dissipation Mounting hardware for all ceiling types; trim and trimless EZ clip mounting for secure installation
Suspension	72" standard length suspension, field adjusted 2" dia. surface mount, or 5" dia. for 4" j-box
Cover	RRC - Round Recessed Cone for low brightness, general illumination with angled cone
LED	Constant Current, 92+ CRI (standard), 2-Step MacAdam Mid output (delivers up to 83 lumens per watt) 2700K, 3000K, 3500K, 4000K Warm Dim (1800 - 3000K) L70 (TM21 Projected 85° C) Static White = 33,300 hours, WD = 55,000 hours
Beam	20°, 25°, 35°, 50°
Driver	Remote drivers for all dimming and non-dimming applications Non-Dim, 0-10V, Phase, Lutron, DALI driver options POE driver compatibility
Warranty	5-year Limited (see complete company warranty information)
Certifications	ETL and ETL-C for dry and damp location, CE

Canopy

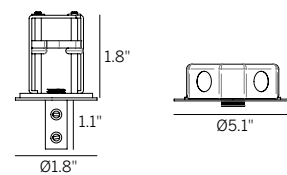

2" dia
5" dia for
4" j-box

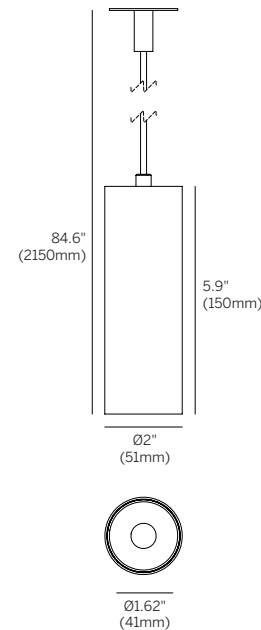
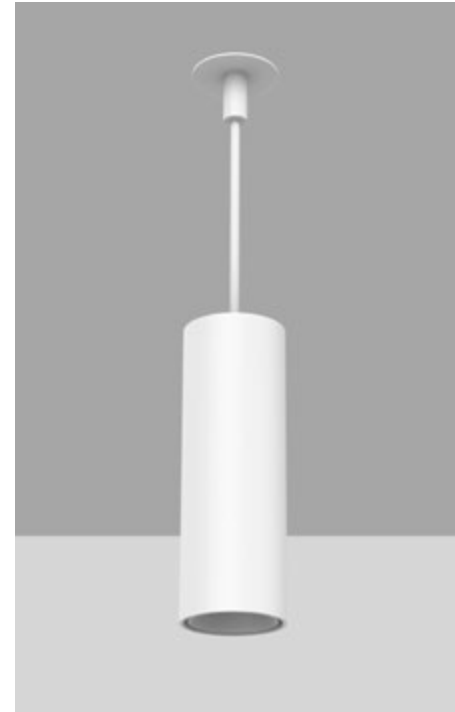

1.5" ProTools Downlight Round Suspended Cylinder

Model	Suspension	Canopy	Power ¹	CRI	CCT ²	Driver ³	Cover	Lens	Beam	Trim Finish	Housing Finish	Options
WG-40RPTDL	S	2 5	M	92	27 30 35 40 WD	RS010 RD010 RSPH RPEQO RD2S X	RRC	OA ⁴ SOL ⁴ LSL ⁴ HL ⁴ DF	20 25 35 50	W (std) B S F	W (std) B S F	EM AWNRF

Model

- WG-40RPTDL = 1.5" ProTools Downlight Round Suspended Cylinder

Suspension

- S = Suspension, 72" standard length, field adjusted

Canopy

- 2 = 2" dia. surface mount
- 5 = 5" dia. for 4" j-box

Power¹

- M = Mid Power, 9.1W @ 500mA

CRI

- 92 = 92 CRI

CCT²

- 27 = 2700K
- 30 = 3000K
- 35 = 3500K
- 40 = 4000K
- WD = Warm Dimming 1800 - 3000K

Remote Driver³

- RS010 = Remote eldoLED 0-10V 1% dimming, 120-277V (22W, 50W or 100W)
- RD010 = Remote eldoLED 0-10V 0.1% dimming, 120-277V (22W, 50W or 100W)
- RSPH = Remote phase (2-wire) 3% dimming, 120V only (20W)
- RPEQO = Remote Lutron Hi-Lume Premier 0.1% EcoSystem dimming, 120-277V (20W)
- RD2S = Remote DALI-2 (DT6) for Static White 0.1% dimming, 120-277V (22W, 50W or 100W)
- X = No Driver

Cover

- RRC = Round Recessed Cone

Lens

- OA = Open Aperture (clear lens provided standard)⁴
- SOL = Solite Lens⁴
- LSL = Linear Spread Lens⁴
- HL = Honeycomb Louver⁴
- DF = Diffusing Film

Beam

- 20 = 20° Beam Angle
- 25 = 25° Beam Angle
- 35 = 35° Beam Angle
- 50 = 50° Beam Angle

Cover Finish

- W = White, 15% gloss, RAL 9003 (standard)
- B = Black, 15% gloss, RAL 9005
- S = Silver, 15% gloss, RAL 9006
- F = Custom finish, specify RAL code

Housing Finish

- W = White, 15% gloss, RAL 9003 (standard)
- B = Black, 15% gloss, RAL 9005
- S = Silver, 15% gloss, RAL 9006
- F = Custom finish, specify RAL code

Options

- EM = Emergency (remote only)
- AWNRF = Lutron Athena Wireless Node RF (RS010, RD010, RD2S drivers only)

Whitegoods reserves the right to change any information without prior notice.

Notes

1. Wattage shown does not include power supplies / drivers.
2. See photometric data sheet for delivered lumens.
3. See driver information page for details.
4. One accessory per fixture.

index

technical
information





2.4" Downlights

The **2.4" General Downlights (GDL)** family offers round flush, recessed and wall washers for indoor and outdoor applications with a bezel trim requiring very minimal ceiling depth while delivering low brightness illumination.

- Downlight
- Wall Wash
- Wet Location

Application guide
Product details

28-31
66-69



2.4" General Downlights (GDL) ease of Installation

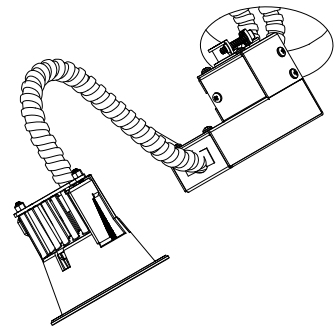

Pull Power Cable and Control Cable through the ceiling opening.

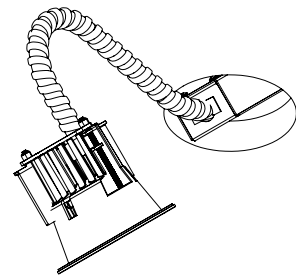

Insert the Driver Housing into the ceiling opening.

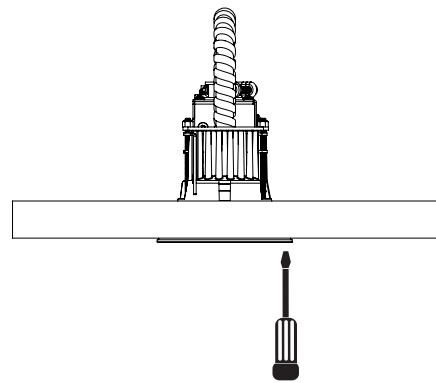

Screw the 2 philips head screws clockwise to engage the Ceiling Brackets.

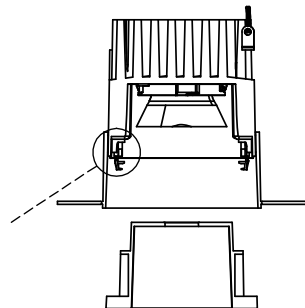

Click the Cover into the Housing for final installation.



2.4" General Downlights (GDL)

The Whitegoods GDL was designed to be an all-purpose, budget conscious solution where a small aperture downlight family with minimal ceiling depth requirement is preferred, for both . Flush lens downlight for high-angle illumination and cone reflector downlight for optimal brightness control, both available in wet location for showers and outdoors, and wallwash fixtures are used in multi-residential projects, hotels, restaurants and residences. Integral, shallow depth driver and housing combinations, as well as remote driver options expand the range and make it the choice when ceiling depth is at a premium.

Fixed Downlights



2.4" General Downlight
Round Recessed

66



2.4" General Downlight
Wall Wash

68

Wall Wash



index

2.4" General Downlight Round Recessed



2.4" round aperture downlight for wide distribution general illumination. Available with round recessed cone with 0.7" regressed 1" diameter light aperture or high transmission, evenly illuminated flush full aperture diffuser.

Housing	Die-cast aluminum for precision fit and heat dissipation 3/8" bezel trim compatible with installation from below into ACT, drywall and hard ceilings Quick-screw mounting mechanism EZ-Click Cover installation
Covers	RRC - Round Recessed Cone for low brightness, general illumination with angled cone RFD - Round Flush Diffuser for high angle illumination with flush, full aperture lens
LED	Constant Current, 80+ CRI (standard), 92 CRI, 2-Step MacAdam Low/Mid/High output choices (delivers up to 65 lumens per watt) 2700K, 3000K, 3500K, 4000K L70 (TM21 Projected 85° C) Static White = 55,400 hours
Optics	100° and Lambertian beam spreads
Driver	Integral and remote drivers for all dimming and non-dimming applications 0-10V, Phase and Lutron driver options Through-wire integral driver enclosure installed from below without the need for bulky housing POE driver compatibility
Installation Housing	LP - Landing Pan NC - New Construction IC - Insulated Ceiling CP - Chicago Plenum X - No Housing (Optional)
Warranty	5-year Limited (see complete company warranty information)
Certifications	ETL and ETL-C for dry and damp location (WL Wet Location optional), CE

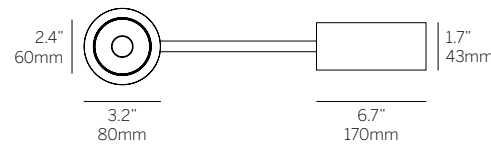
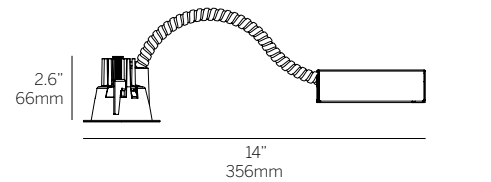
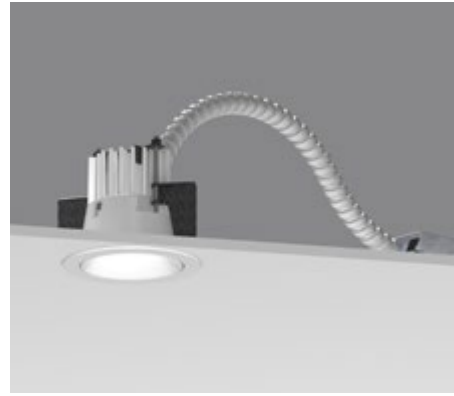

Standard housing

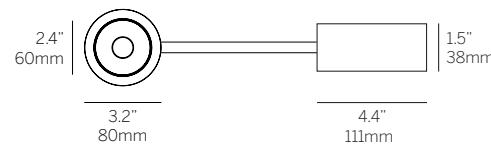
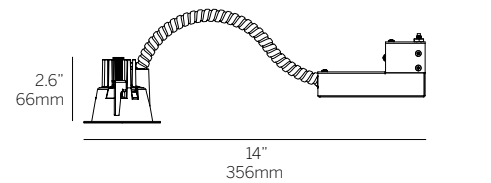

Shallow housing (SH)

2.4" General Downlight Round Recessed

Model	Fixation	Power ¹	CRI	CCT ²	Driver ³	Cover	Lens	Beam	Trim Finish	Cone Finish	Housing ⁴	Options
WG-60RGDL	RBT	L M H	80 92	27 30 35 40	S010 SPH PEQ0 RS010 RD010 X	RRC	RSC	100	W (std) B S F	W (std) B S F	LP NC IC CP X	WL SH EM AWNRF
						RFD	SOD	LAM				

Model

- WG-60RGDL = 2.4" General Downlight Round Regressed Cone

Fixation

- RBT = Recessed Bezel Trim

Power¹

- L = Low power, 5.7W @ 350mA
- M = Mid power, 8.4W @ 500mA
- H = High power, 12W @ 700mA

CRI

- 80 = 80 CRI (standard)
- 92 = 92 CRI

CCT²

- 27 = 2700K
- 30 = 3000K
- 35 = 3500K
- 40 = 4000K

Driver (Integral)³

- S010 = 0-10V 10% dimming, 120-277V (15W)
- SPH = Phase (2-wire) 3% dimming, 120V only (20W)
- PEQ0 = Lutron Hi-Lume Premier 0.1% EcoSystem dimming, 120-277V (20W)

Driver (Remote)³

- RS010 = Remote eldoLED 0-10V 1% dimming, 120-277V (22W, 50W, or 100W)
- RD010 = Remote eldoLED 0-10V 0.1% dimming, 120-277V (22W, 50W or 100W)
- X = No driver

Cover

- RRC = Round Recessed Cone
- RFD = Round Flush Opal Diffuser

Lens

- RSC = Recessed Satin Clear (RRC only)
- SOD = Satin Opal Diffuser (RFD only)

Beam

- 100 = 100° Beam
- LAM = Lambertian

Trim Finish

- W = White, 15% gloss, RAL 9003 (standard)
- B = Black, 15% gloss, RAL 9005
- S = Silver, 15% gloss, RAL 9006
- F = Custom finish, specify RAL

Cover Finish

- W = White, 15% gloss, RAL 9003 (standard)
- B = Black, 15% gloss, RAL 9005
- S = Silver, 15% gloss, RAL 9006
- F = Custom finish, specify RAL

Housing (Optional)⁴

- LP = Landing Pan
- NC = New Construction Housing
- IC = Insulated Ceiling Housing
- CP = Chicago Plenum Housing
- X = No Housing

Options

- WL = Wet Location
- SH = Reduces required plenum space to 3.5" (89mm)
- EM = Emergency (remote)
- AWNRF = Lutron Athena Wireless Node RF (RS010, RD010 drivers only)

Whitegoods reserves the right to change any information without prior notice.

Notes

- Wattage shown does not include power supplies/drivers.
- See photometric data sheet for delivered lumens.
- See driver information for details.
- See housings page for details.

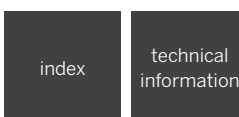

2.4" General Downlight Round Wall Wash



2.4" round aperture wall wash with semi-recessed kick reflector for wall wash applications.

Housing	Die-cast aluminum for precision fit and heat dissipation 3/8" bezel trim compatible with installation from below into ACT, drywall and hard ceilings Quick-screw mounting mechanism EZ-Click Cover installation
Covers	RSRWW - Round Semi-Recessed Wall Wash for semi-recessed room-side cutoff
LED	Constant Current, 80+ CRI (standard), 92 CRI, 2-Step MacAdam Low/Mid/High output choices (delivers up to 65 lumens per watt) 2700K, 3000K, 3500K, 4000K L70 (TM21 Projected 85° C) Static White = 55,400 hours
Optics	WW Wall Wash
Driver	Integral and remote drivers for all dimming and non-dimming applications 0-10V, Phase and Lutron driver options Through-wire integral driver enclosure installed from below without the need for bulky housing POE driver compatibility
Installation Housing	LP - Landing Pan NC - New Construction IC - Insulated Ceiling CP - Chicago Plenum X - No Housing (Optional)
Warranty	5-year Limited (see complete company warranty information)
Certifications	ETL and ETL-C for dry and damp location (WL Wet Location optional), CE

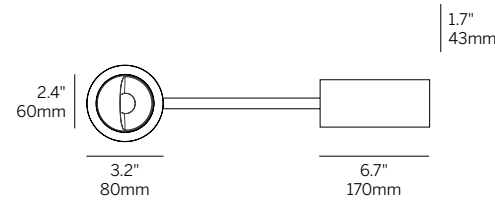
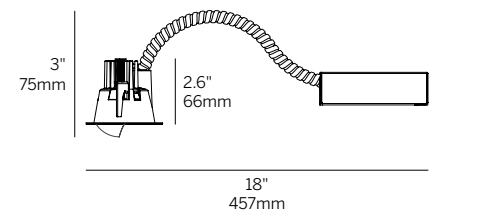
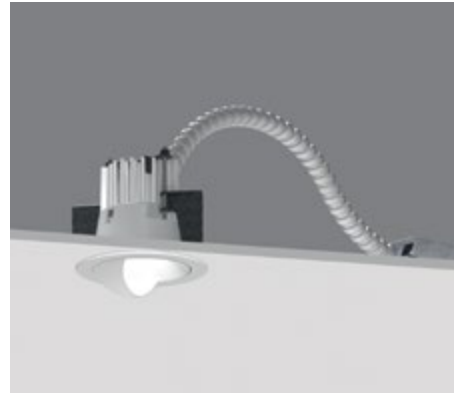

Standard housing

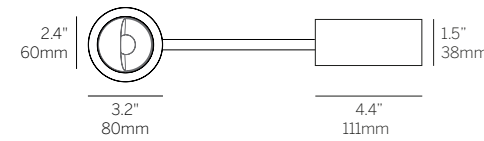
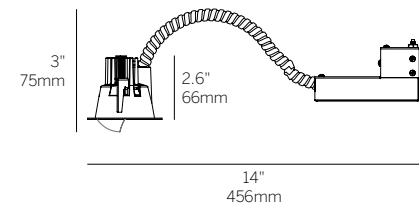

Shallow housing (SH)

2.4" General Downlight Round Wall Wash

Model	Fixation	Power ¹	CRI	CCT ²	Driver ³	Cover	Lens	Beam	Trim Finish	Cone Finish	Housing ⁴	Options
WG-60RGDL	RBT	L M H	80 92	27 30 35 40	S010 SPH PEQ0 RS010 RD010 X	RSRWW	RSC	WW	W (std) S F	W (std) S F	LP NC IC CP X	WL SH EM AWNRF

Model

- WG-60RGDL = 2.4" General Downlight Round Wall Wash

Fixation

- RBT = Recessed Bezel Trim

Power¹

- L = Low power, 5.7W @ 350mA
- M = Mid power, 8.4W @ 500mA
- H = High power, 12W @ 700mA

CRI

- 80 = 80 CRI (standard)
- 92 = 92 CRI

CCT²

- 27 = 2700K
- 30 = 3000K
- 35 = 3500K
- 40 = 4000K

Driver (Integral)³

- S010 = 0-10V 10% dimming, 120-277V (15W)
- SPH = Phase (2-wire) 3% dimming, 120V only (20W)
- PEQ0 = Lutron Hi-Lume Premier 0.1% EcoSystem dimming, 120-277V (20W)

Driver (Remote)³

- RS010 = Remote eldoLED 0-10V 1% dimming, 120-277V (22W, 50W, or 100W)
- RD010 = Remote eldoLED 0-10V 0.1% dimming, 120-277V (22W, 50W or 100W)
- X = No driver

Cover

- RSRWW = Round Semi-Recessed Wall Wash

Lens

- RSC = Recessed Satin Clear

Beam

- WW = Wall Wash

Trim Finish

- W = White, 15% gloss, RAL 9003 (standard)
- S = Silver, 15% gloss, RAL 9006
- F = Custom finish, specify RAL

Cover Finish

- W = White, 15% gloss, RAL 9003 (standard)
- S = Silver, 15% gloss, RAL 9006
- F = Custom finish, specify RAL

Housing (Optional)⁴

- LP = Landing Pan
- NC = New Construction
- IC = Insulated Ceiling
- CP = Chicago Plenum
- X = No Housing

Options

- WL = Wet Location
- SH = Reduces required plenum space to 3.5" (89mm)
- EM = Emergency (remote)
- AWNRF = Lutron Athena Wireless Node RF (RS010, RD010 drivers only)

Whitegoods reserves the right to change any information without prior notice.

Notes

- Wattage shown does not include power supplies/drivers.
- See photometric data sheet for delivered lumens.
- See driver information for details.
- See housings page for details.

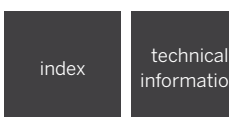

3" ProTools Downlights

3" ProTools Downlights family offers small size, high performance fixed or adjustable downlights and wall washers with a variety of cover options available in round or square, trimmed or trimless and multiple luminaire configurations. The fixtures are simple in nature, designed for modularity and include Whitegoods attention to seamless integration with surrounding materials

- Downlight
- Adjustable
- Wall Wash
- Wet Location

Application guide
Product details

28-31
80-95





3" ProTools Range Logic

The ProTools range allows the specifier freedom to design for all spaces and environments within a project from one succinct, logical and aesthetically congruent range of luminaires. The comprehensive options cover all of the designer's needs.

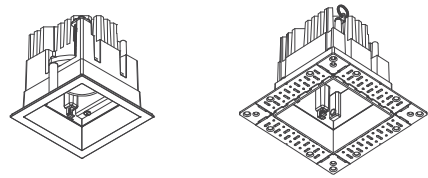

Bezel Fixed

Plaster Fixed

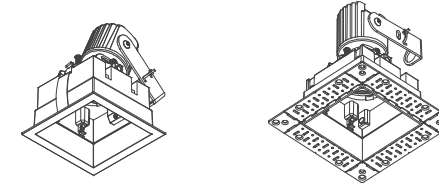

Bezel Adjustable

Plaster Adjustable

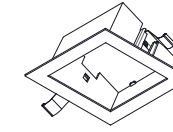

Bezel Accent Wall Wash

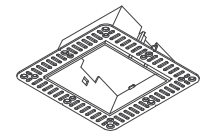

Plaster Accent Wall Wash

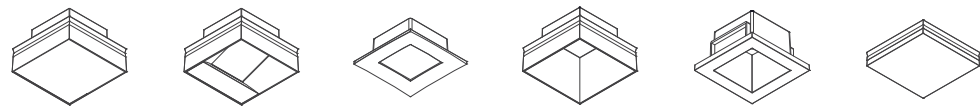

Flush Diffuser

Wall Wash

Regressed Pinhole

Recessed Cone

Flush Pinhole

Regressed Diffuser

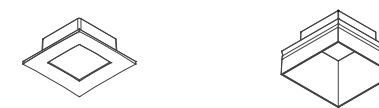

Regressed Pinhole

Recessed Cone

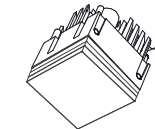

Accent Wall Wash



Bezel Fixed

Plaster Fixed

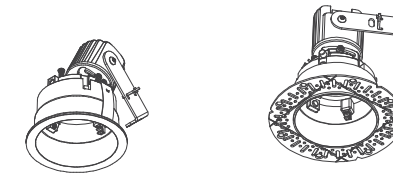

Bezel Adjustable

Plaster Adjustable

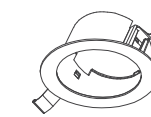

Bezel Accent Wall Wash



Plaster Accent Wall Wash



Flush Diffuser

Wall Wash

Regressed Pinhole

Recessed Cone

Flush Pinhole

Regressed MPO Lens

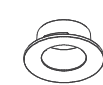

Regressed Pinhole



Recessed Cone

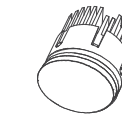

Accent Wall Wash

3" ProTools ease of Installation

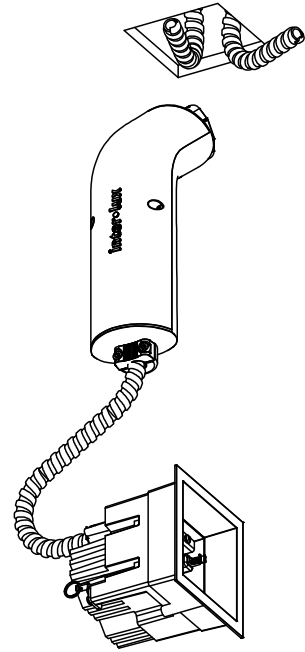

Pull power cable and control cable through the ceiling opening.

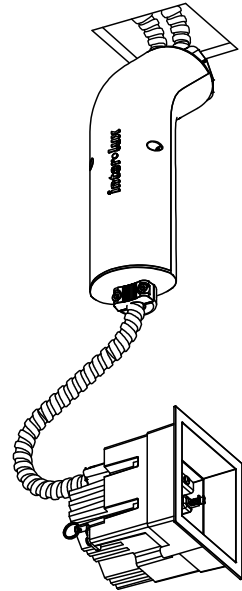

Insert the driver housing into the ceiling opening.

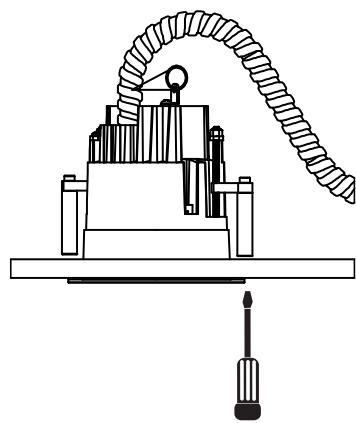

Screw the 2 philips head screws clockwise to engage the ceiling brackets.

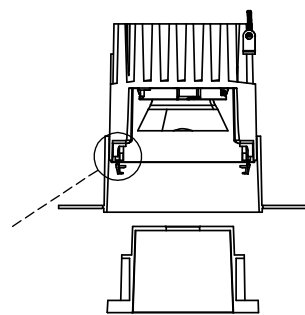

Cover should be inserted by level alignment so the (4) Push Latches engage and hold the Cover into place.

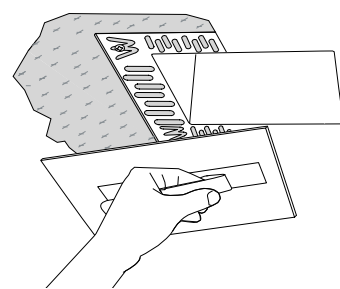

Install using 'tape-and-joint' method, or plaster finish. Clean excess plaster while still wet.

3" ProTools Multiple Luminaire Configurations

Multiple fixture configurations can be accomplished using standard plaster-trim Downlight Frames.

With ProTools 3" Downlights you never have to purchase a specialized housing in order to realize a multiple configuration. In fact, you can simply snap off segments of the plaster-trim on standard product and field join the Frames during installation.

You simply specify the standard product.

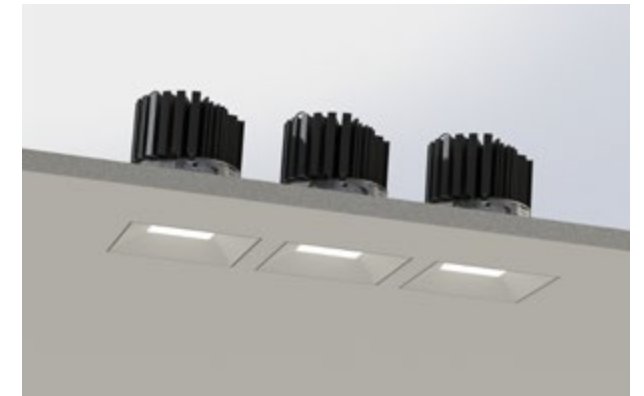
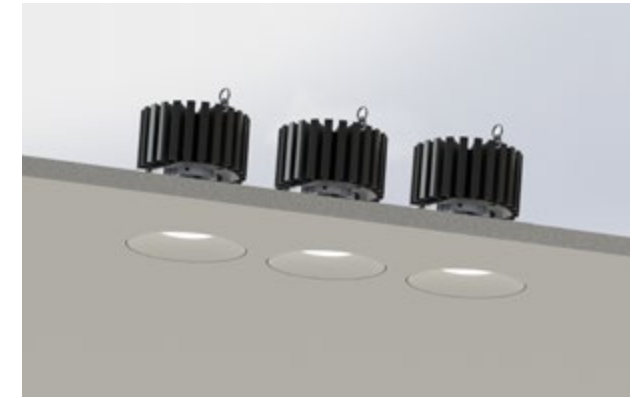

① Select which side of the plaster trim to remove.

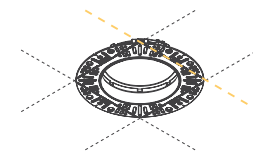

④ ...to create "multiple" configurations, which would usually require additional dedicated housings.

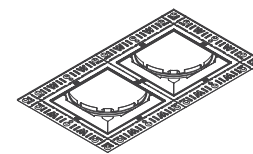

② Use a pair of multi-grip pliers and firmly snap off the trim with one swift movement.



⑤ Any number of frames can be grouped together to form linear configurations.

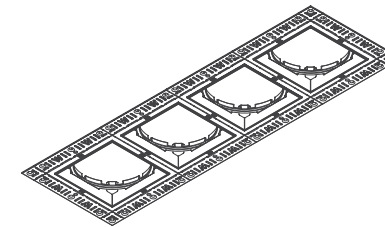

③ Installation frames can now be fixed directly next to one another...

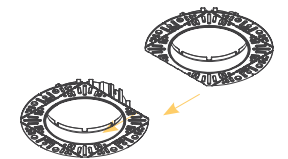

3" ProTools Downlights

Fixed Downlights



3" ProTools Downlight Round Recessed

80



3" ProTools Downlight Square Recessed

82

Adjustable Downlights



3" ProTools Adjustable Round Recessed

84



3" ProTools Adjustable Square Recessed

86

Wall Wash



3" ProTools Wall Wash Round Recessed

88



3" ProTools Wall Wash Square Recessed

90



3" ProTools Accent Wall Wash Round Recessed

92



3" ProTools Accent Wall Wash Square Recessed

94

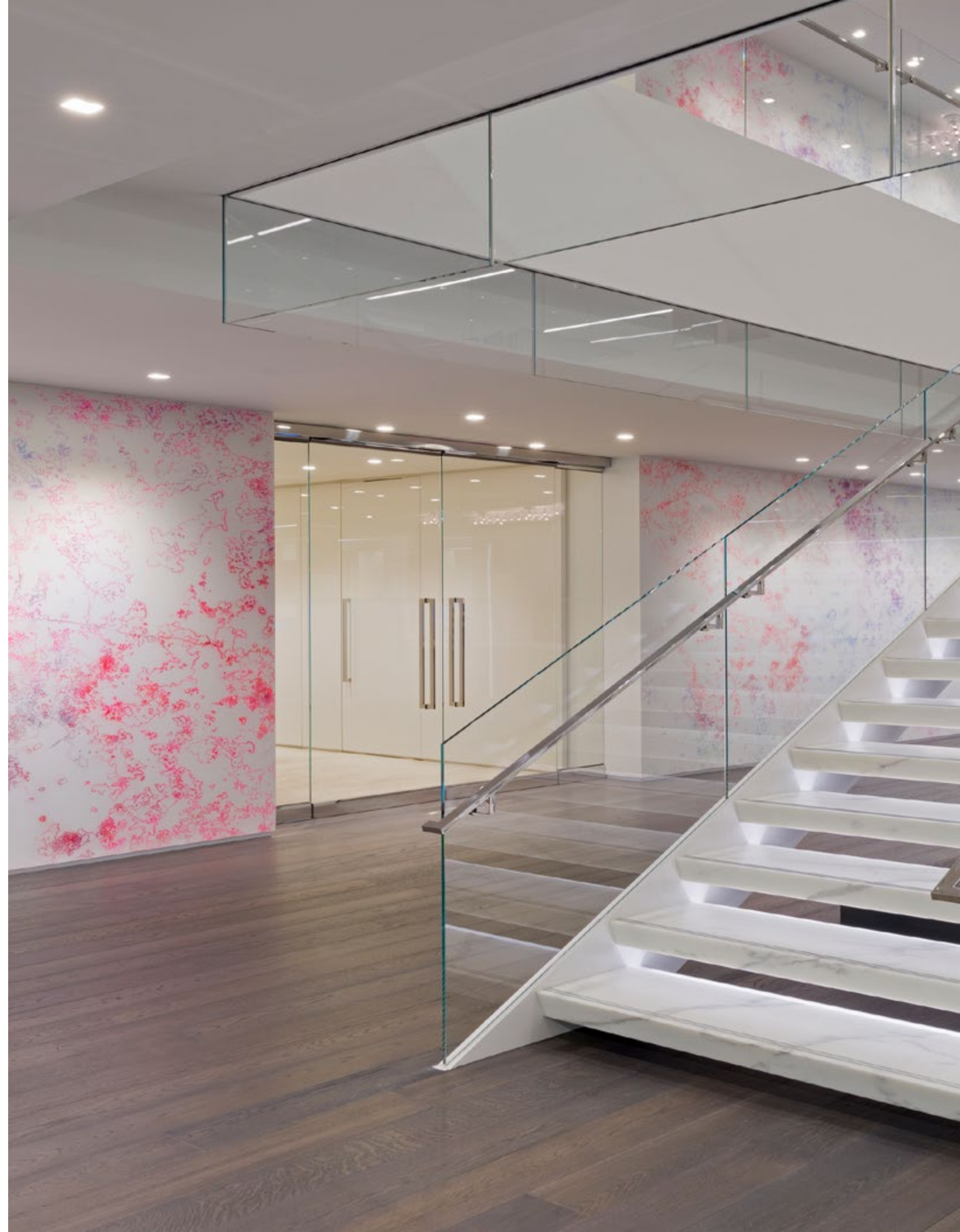

3" ProTools Downlight Round Recessed



3" round aperture recessed downlight available with multiple regressed or flush cover options.

Housing	Die-caste aluminum for precision fit and heat dissipation Mounting hardware for all ceiling types; trim and trimless Quick-screw mounting mechanism EZ-Click Cover installation Trimless housing with Multiple Luminaire Configurations feature allows endless multiple combinations without specialized housings
Covers	RRC = Round Recessed Cone for low brightness, general illumination with angled cone RRPH = Round Regressed Pinhole for low brightness, general illumination with regressed aperture RFPH = Round Flush Pinhole for low brightness, general illumination with flush aperture RRD = Round Regressed Diffuser for high angle illumination with 1/4" regressed, full aperture lens RFD = Round Flush Diffuser for high angle illumination with flush, full aperture lens
LED	Constant Current, 92+ CRI (standard), 98 CRI / 95 CRI WD (optional), 2-Step MacAdam Low/Mid/High output choices (delivers up to 92 lumens per watt) 2700K, 3000K, 3500K, 4000K Tunable White (1800 - 4000K) Warm Dim (1800 - 3000K) L70 (TM21 Projected 85° C) Static White = 55,400 hours, TW + WD = 55,000 hours
Beam	20°, 30°, 50°, 100° and Lambertian beam spreads
Driver	Integral and remote drivers for all dimming and non-dimming applications Non-Dim, 0-10V, Phase, Lutron and DALI driver options Through-wire integral driver enclosure installed from below without the need for bulky housing POE driver compatibility
Installation Housing	Not required when using the Driver Enclosure LP - Landing Pan NC - New Construction IC - Insulated Ceiling CP - Chicago Plenum
Warranty	5-year Limited (see complete company warranty information)
Certifications	ETL and ETL-C for dry and damp location (WL Wet Location optional), CE

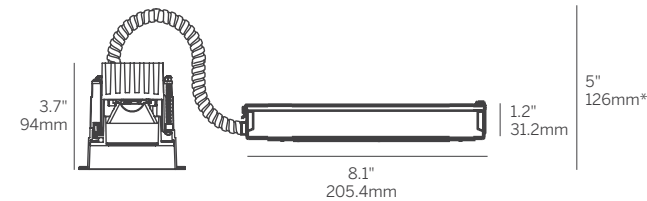
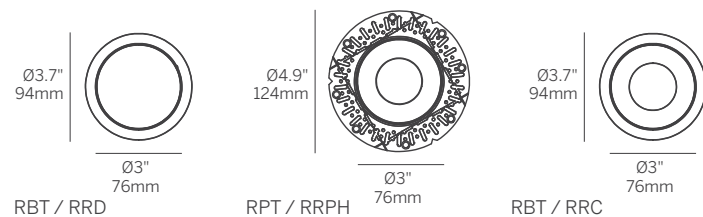

RBT / RRC / OA



RBT / RRD / MPO



RPT / RFPH / OA



RPT / RRPH / RSC

3" ProTools Downlight Round Recessed

Model	Fixation	Power ¹	CRI	CCT ²	Driver ³	Cover	Lens	Beam	Trim Finish	Cover Finish	Housing ⁴	Options
WG-75RPTDL	RBT RPT	L	92	27	S010	RRC	OA	20	W B S F	W B S F	LP NC IC CP X	WL MLC EM AWNRF
		M	98	30 35 40	SPH PEQO D2S	RRPH	RSC	30 50				
		H			RD2S	RFPH						
		TW	92	TW	RS010	RRD	MPO	100				
		WD	95	WD	RD010 RD2S RD2T X	RFD	SOD	LAM				

Model

- WG-75RPTDL = 3" ProTools Downlight Round Recessed

Fixation

- RBT = Recessed Bezel Trim
- RPT = Recessed Plaster Trim

Power¹

- L = Low Power, 5.7W @ 350mA
- M = Mid Power, 8.4W @ 500mA
- H = High Power, 12W @ 700mA
- TW = 9W @ 500mA
- WD = 11.8W @ 350mA

CRI

- 92 = 92 CRI (Static White, TW only)
- 98 = 98 CRI (Static White)
- 95 = 95 CRI (WD only)

CCT²

- 27 = 2700K
- 30 = 3000K
- 35 = 3500K
- 40 = 4000K
- TW = Tunable White 1800 - 4000K
- WD = Warm Dimming 1800 - 3000K

Integral Driver³

- S010 = eldoLED 0-10V 1% dimming, 120-277V (22W)
- D010 = eldoLED 0-10V 0.1% dimming, 120-277V (22W)
- SPH = Phase (2-wire) 3% dimming, 120V only (20W)
- PEQO = Lutron Hi-Lume Premier 0.1% EcoSystem dimming, 120-277V (20W)
- D2S = DALI-2 (DT6) for Static White 0.1% dimming, 120-277V (22W)

Remote Driver³

- RS010 = Remote eldoLED 0-10V 1% dimming, 120-277V (22W, 50W or 100W)
- RD010 = Remote eldoLED 0-10V 0.1% dimming, 120-277V (22W, 50W or 100W)
- RD2S = Remote DALI-2 (DT6) for Static White 0.1% dimming, 120-277V (22W, 50W or 100W)
- RD2T = Remote DALI-2 (DT8) for Tunable White 0.1% dimming, 120-277V (30W, 50W or 75W)
- X = No driver

Cover

- RRC = Round Recessed Cone (OA, RSC only)
- RRPH = Round Regressed Pinhole (OA, RSC only)
- RFPH = Round Flush Pinhole (OA, RSC only)
- RRD = Round Regressed Diffuser (MPO only)
- RFD = Round Flush Diffuser (SOD only)

Lens

- OA = Open Aperture
- RSC = Recessed Satin Clear Lens
- MPO = Micro Prismatic Opal Diffuser
- SOD = Satin Opal Diffuser

Beam

- 20 = 20° Beam Angle
- 30 = 30° Beam Angle
- 50 = 50° Beam Angle
- 100 = 100° Beam Angle (RRD only)
- LAM = Lambertian (RFD only)

Trim Finish

- W = White, 15% gloss, RAL 9003 (standard)
- B = Black, 15% gloss, RAL 9005
- S = Silver, 15% gloss, RAL 9006
- F = Custom finish, specify RAL code

Cover Finish

- W = White, 15% gloss, RAL 9003 (standard)
- B = Black, 15% gloss, RAL 9005
- S = Silver, 15% gloss, RAL 9006
- F = Custom finish, specify RAL code

Housing (Optional)⁴

- LP = Landing Pan
- NC = New Construction Housing
- IC = Insulated Ceiling Housing
- CP = Chicago Plenum Housing
- X = No Housing

Options

- WL = Wet Location (available only with RRC and RRD)
- MLC = Multiple Luminaire Configurations (RPT only - see detail page)
- EM = Emergency (remote only)
- AWNRF = Lutron Athena Wireless Node RF (RS010, RD010, RD2S, RD2T drivers only)

Whitegoods reserves the right to change any information without prior notice.

Notes

- Wattage shown does not include power supplies/drivers.
- See photometric data sheet for delivered lumens.
- See driver information for details.
- See housings pages for details.

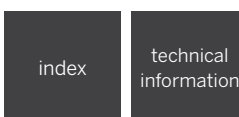

*Minimum of 5" (126mm) ceiling void is required to install the integral driver from below the ceiling.

3" ProTools Downlight Square Recessed



3" round aperture recessed downlight available with multiple regressed or flush cover options.

Housing	Die-caste aluminum for precision fit and heat dissipation Mounting hardware for all ceiling types; trim and trimless Quick-screw mounting mechanism EZ-Click Cover installation Trimless housing with Multiple Luminaire Configurations feature allows endless multiple combinations without specialized housings
Covers	SRC = Square Recessed Cone for low brightness, general illumination with angled cone SRPH = Square Regressed Pinhole for low brightness, general illumination with regressed aperture SFPH = Square Flush Pinhole for low brightness, general illumination with flush aperture SRD = Square Regressed Diffuser for high angle illumination with 1/4" regressed, full aperture lens SFD = Square Flush Diffuser for high angle illumination with flush, full aperture lens
LED	Constant Current, 92+ CRI (standard), 98 CRI / 95 CRI WD (optional), 2-Step MacAdam Low/Mid/High output choices (delivers up to 92 lumens per watt) 2700K, 3000K, 3500K, 4000K Tunable White (1800 - 4000K) Warm Dim (1800 - 3000K) L70 (TM21 Projected 85° C) Static White = 55,400 hours, TW + WD = 55,000 hours
Beam	20°, 30°, 50°, 100° and Lambertian beam spreads
Driver	Integral and remote drivers for all dimming and non-dimming applications Non-Dim, 0-10V, Phase, Lutron and DALI driver options Through-wire integral driver enclosure installed from below without the need for bulky housing POE driver compatibility
Installation Housing	Not required when using the Driver Enclosure LP - Landing Pan NC - New Construction IC - Insulated Ceiling CP - Chicago Plenum
Warranty	5-year Limited (see complete company warranty information)
Certifications	ETL and ETL-C for dry and damp location (WL Wet Location optional), CE

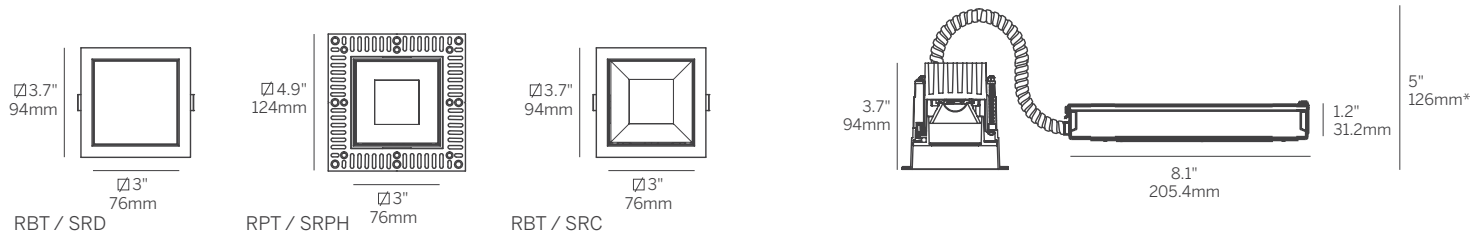

RBT / SRC / OA



RBT / SRD / MPO



RPT / SFPH / OA



RPT / SRPH / OA

3" ProTools Downlight Square Recessed

Model	Fixation	Power ¹	CRI	CCT ²	Driver ³	Cover	Lens	Beam	Trim Finish	Cover Finish	Housing ⁴	Options
WG-75SPTDL	RBT RPT	L M H TW WD	92 98	27 30 35 40 TW WD	S010 D010 SPH PEQO D2S RS010 RD010 RD2S RD2T X	SRC	OA RSC	20 30 50	W B S F	W B S F	LP NC IC CP X	WL WC MLC EM AWNRF
						SRD	MPO	100				
						SFD	SOD	LAM				

Model

- WG-75SPTDL = 3" ProTools Downlight Square Recessed

Fixation

- RBT = Recessed Bezel Trim
- RPT = Recessed Plaster Trim

Power¹

- L = Low Power, 5.7W @ 350mA
- M = Mid Power, 8.4W @ 500mA
- H = High Power, 12W @ 700mA
- TW = 9W @ 500mA
- WD = 11.8W @ 350mA

CRI

- 92 = 92 CRI (Static White, TW only)
- 98 = 98 CRI (Static White)
- 95 = 95 CRI (WD only)

CCT²

- 27 = 2700K
- 30 = 3000K
- 35 = 3500K
- 40 = 4000K
- TW = Tunable White 1800 - 4000K
- WD = Warm Dimming 1800 - 3000K

Integral Driver³

- S010 = eldoLED 0-10V 1% dimming, 120-277V (22W)
- D010 = eldoLED 0-10V 0.1% dimming, 120-277V (22W)
- SPH = Phase (2-wire) 3% dimming, 120V only (20W)
- PEQO = Lutron Hi-Lume Premier 0.1% EcoSystem dimming, 120-277V (20W)
- D2S = DALI-2 (DT6) for Static White 0.1% dimming, 120-277V (22W)

Remote Driver³

- RS010 = Remote eldoLED 0-10V 1% dimming, 120-277V (22W, 50W or 100W)
- RD010 = Remote eldoLED 0-10V 0.1% dimming, 120-277V (22W, 50W or 100W)
- RD2S = Remote DALI-2 (DT6) for Static White 0.1% dimming, 120-277V (22W, 50W or 100W)
- RD2T = Remote DALI-2 (DT8) for Tunable White 0.1% dimming, 120-277V (30W, 50W or 75W)
- X = No driver

Cover

- SRC = Square Recessed Cone (OA, RSC only)
- SRPH = Square Regressed Pinhole (OA, RSC only)
- SFPH = Square Flush Pinhole (OA, RSC only)
- SRD = Square Regressed Diffuser (MPO only)
- SFD = Square Flush Diffuser (SOD only)

Lens

- OA = Open Aperture
- RSC = Recessed Satin Clear Lens
- MPO = Micro-prismatic Opal Diffuser
- SOD = Satin Opal Diffuser

Beam

- 20 = 20° Beam Angle
- 30 = 30° Beam Angle
- 50 = 50° Beam Angle
- 100 = 100° Beam Angle (MPO Only)
- LAM = Lambertian (SOD Only)

Trim Finish

- W = White, 15% gloss, RAL 9003 (standard)
- B = Black, 15% gloss, RAL 9005
- S = Silver, 15% gloss, RAL 9006
- F = Custom finish, specify RAL code

Cover Finish (N/A for SRD / SFD)

- W = White, 15% gloss, RAL 9003 (standard)
- B = Black, 15% gloss, RAL 9005
- S = Silver, 15% gloss, RAL 9006
- F = Custom finish, specify RAL code

Housing (optional)⁴

- LP = Landing Pan
- NC = New Construction Housing
- IC = Insulated Ceiling Housing
- CP = Chicago Plenum Housing
- X = No Housing

Options

- WL = Wet Location (available only with SRC and SRD)
- WC = Wood Ceiling Adapter (RPT only - specify ceiling thickness)
- MLC = Multiple Luminaire Configurations (RPT only - see detail page)
- EM = Emergency (remote only)
- AWNRF = Lutron Athena Wireless Node RF (RS010, RD010, RD2S, RD2T drivers only)

Whitegoods reserves the right to change any information without prior notice.

Notes

- Wattage shown does not include power supplies/drivers.
- See photometric data sheet for delivered lumens.
- See driver information for details.
- See housings pages for details.

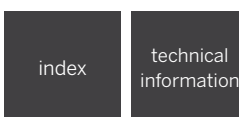

*Minimum of 5" (126mm) ceiling void is required to install the integral driver from below the ceiling.

3" ProTools Adjustable Round Recessed



3" round aperture recessed adjustable downlight with 1.6" diameter regressed light aperture. Tilt 40°, rotation 360° (continuous).

Housing	Die-caste aluminum for precision fit and heat dissipation Mounting hardware for all ceiling types; trim and trimless Quick-screw spring mounting mechanism EZ-Click Cover installation Trimless housing with Multiple Luminaire Configurations feature allows endless multiple combinations without specialized housings
Covers	RRC - Round Recessed Cone for low brightness, general illumination with angled cone. RRPH - Round Regressed Pinhole for low brightness, general illumination with regressed aperture (12° and 25° only).
LED	Constant Current, 92+ CRI, 2-Step MacAdam (12° Beam 3-Step) Low/Mid/High output choices (delivers up to 68 lumens per watt) 2700K, 3000K, 3500K, 4000K L70 (TM21 Projected 85°C) Static White 66,500 hours (12° Beam 109,000 hours)
Beam	12°, 25°, 36° beam spreads
Driver	Integral and remote drivers for all dimming and non-dimming applications Non-Dim, 0-10V, Phase, Lutron and DALI driver options Through-wire integral driver enclosure installed from below without the need for bulky housing POE driver compatibility
Installation Housing	Not required when using the Driver Enclosure LP - Landing Pan NC - New Construction IC - Insulated Ceiling CP - Chicago Plenum
Warranty	5-year Limited (see complete company warranty information)
Certifications	ETL and ETL-C for dry and damp location (WL Wet Location optional), CE



RBT / RRC / OA



RPT / RRC / OA



RBT / RRP / RSC



RPT / RRP / RSC

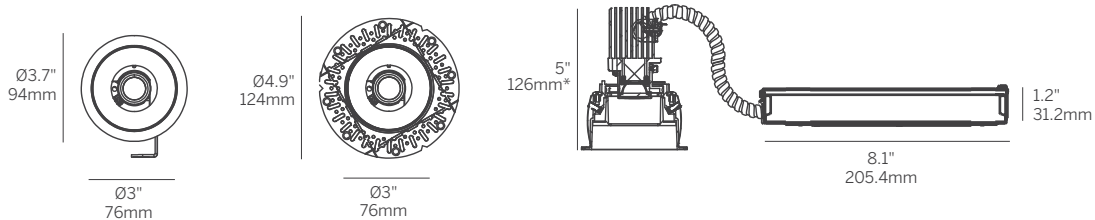

RBT / RRC

RPT / RRP

*Minimum of 5" (126mm) ceiling void is required to install the integral driver from below the ceiling.

3" ProTools Adjustable Round Recessed

Model	Fixation	Power ¹	CRI	CCT ²	Driver ³	Cover	Lens	Beam	Trim Finish	Cover Finish	Housing ⁴	Options
WG-75RPTA	RBT RPT	L M H	92	27 30 35 40	S010 D010 SPH PEQ0 D2S RS010 RD010 RD2S X	RRC RRPH	OA RSC	12 25 36	W B S F	W B S F	LP NC IC CP X	WL MLC AS ASL HL EM AWNRF

Model

- WG-75RPTA = 3" ProTools Adjustable Round Recessed

Fixation

- RBT = Recessed Bezel Trim
- RPT = Recessed Plaster Trim

Power¹

- L = Low Power, 5.6W @ 350mA (3.9W for 12°)
- M = Mid Power, 8.1W @ 500mA (5.8W for 12°)
- H = High Power, 11.5W @ 700mA (8.3W for 12°)

CRI

- 92 = 92+ CRI

CCT²

- 27 = 2700K
- 30 = 3000K
- 35 = 3500K
- 40 = 4000K

Integral Driver³

- S010 = eldoLED 0-10V 1% dimming, 120-277V (22W)
- D010 = eldoLED 0-10V 0.1% dimming, 120-277V (22W)
- SPH = Phase (2-wire) 3% dimming, 120V only (20W)
- PEQ0 = Lutron Hi-Lume Premier 0.1% EcoSystem dimming, 120-277V (20W)
- D2S = DALI-2 (DT6) for Static White 0.1% dimming, 120-277V (22W)

Remote Driver³

- RS010 = Remote eldoLED 0-10V 1% dimming, 120-277V (22W, 50W or 100W)
- RD010 = Remote eldoLED 0-10V 0.1% dimming, 120-277V (22W, 50W or 100W)
- RD2S = Remote DALI-2 (DT6) for Static White 0.1% dimming, 120-277V (22W, 50W or 100W)
- X = No Driver

Cover

- RRC = Round Recessed Cone
- RRPH = Round Regressed Pinhole (N/A with 36° Beam)

Lens

- OA = Open Aperture
- RSC = Recessed Satin Clear Lens

Beam

- 12 = 12° Beam Angle
- 25 = 25° Beam Angle
- 36 = 36° Beam Angle

Trim Finish

- W = White, 15% gloss, RAL 9003 (standard)
- B = Black, 15% gloss, RAL 9005
- S = Silver, 15% gloss, RAL 9006
- F = Custom finish, specify RAL code

Cover Finish

- W = White, 15% gloss, RAL 9003 (standard)
- B = Black, 15% gloss, RAL 9005
- S = Silver, 15% gloss, RAL 9006
- F = Custom finish, specify RAL code

Housing (optional)⁴

- LP = Landing Pan
- NC = New Construction Housing
- IC = Insulated Ceiling Housing
- CP = Chicago Plenum Housing
- X = No Housing

Options

- WL = Wet Location (only available with RRC)
- MLC = Multiple Luminaire Configurations (RPT only - see detail page)
- AS = Aim Stick
- ASL = Aim Stick w/ Laser
- HL = Honeycomb Louver (specify with OA)
- EM = Emergency (remote only)
- AWNRF = Lutron Athena Wireless Node RF (RS010, RD010, RD2S drivers only)

Whitegoods reserves the right to change any information without prior notice.

Notes

- Wattage shown does not include power supplies/drivers.
- Refer to photometric data sheet for delivered lumens.
- See driver information for details.
- See housings pages for details

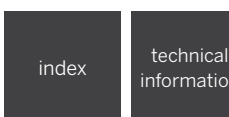

3" ProTools Adjustable Square Recessed



3" square aperture recessed adjustable downlight with 1.6" diameter regressed light aperture.
Tilt 40°, rotation 360° (continuous).

Housing	Die-caste aluminum for precision fit and heat dissipation Mounting hardware for all ceiling types; trim and trimless Quick-screw spring mounting mechanism EZ-Click Cover installation Trimless housing with Multiple Luminaire Configurations feature allows endless multiple combinations without specialized housings
Covers	SRC - Square Recessed Cone for low brightness, general illumination with angled cone SRPH - Square Regressed Pinhole for low brightness, general illumination with regressed aperture (12° and 25° only)
LED	Constant Current, 92+ CRI, 2-Step MacAdam (12° Beam 3-Step) Low/Mid/High output choices (delivers up to 68 lumens per watt) 2700K, 3000K, 3500K, 4000K L70 (TM21 Projected 85°C) Static White 66,500 hours (12° Beam 109,000 hours)
Beam	12°, 25°, 36° beam spreads
Driver	Integral and remote drivers for all dimming and non-dimming applications Non-Dim, 0-10V, Phase, Lutron and DALI driver options Through-wire integral driver enclosure installed from below without the need for bulky housing POE driver compatibility
Installation Housing	Not required when using the Driver Enclosure LP - Landing Pan NC - New Construction IC - Insulated Ceiling CP - Chicago Plenum
Warranty	5-year Limited (see complete company warranty information)
Certifications	ETL and ETL-C for dry and damp location (WL Wet Location optional), CE

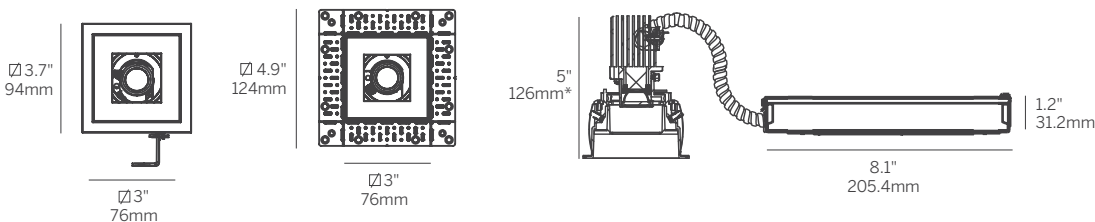

RBT / SRC RPT / SRPH

*Minimum of 5" (126mm) ceiling void is required to install the integral driver from below the ceiling.

3" ProTools Adjustable Square Recessed

Model	Fixation	Power ¹	CRI	CCT ²	Driver ³	Cover	Lens	Beam	Trim Finish	Cover Finish	Housing ⁴	Options
WG-75SPTA	RBT RPT	L M H	92	27 30 35 40	S010 D010 SPH PEQ0 D2S RS010 RD010 RD2S X	SRC SRPH	OA RSC	12 25 36	W B S F	W B S F	LP NC IC CP X	WL MLC AS ASL HL EM AWNRF



RBT / SRC / OA



RPT / SRD / MPO



RBT / SRPH / OA



RPT / SRPH / RSC

Model

- WG-75SPTA = 3" ProTools Adjustable Square Recessed

Fixation

- RBT = Recessed Bezel Trim
- RPT = Recessed Plaster Trim

Power¹

- L = Low Power, 5.6W @ 350mA (3.9W for 12°)
- M = Mid Power, 8.1W @ 500mA (5.8W for 12°)
- H = High Power, 11.5W @ 700mA (8.3W for 12°)

CRI

- 92 = 92+ CRI

CCT²

- 27 = 2700K
- 30 = 3000K
- 35 = 3500K
- 40 = 4000K

Integral Driver³

- S010 = eldoLED 0-10V 1% dimming, 120-277V (22W)
- D010 = eldoLED 0-10V 0.1% dimming, 120-277V (22W)
- SPH = Phase (2-wire) 3% dimming, 120V only (20W)
- PEQ0 = Lutron Hi-Lume Premier 0.1% EcoSystem dimming, 120-277V (20W)
- D2S = DALI-2 (DT6) for Static White 0.1% dimming, 120-277V (22W)

Remote Driver³

- RS010 = Remote eldoLED 0-10V 1% dimming, 120-277V (22W, 50W or 100W)
- RD010 = Remote eldoLED 0-10V 0.1% dimming, 120-277V (22W, 50W or 100W)
- RD2S = Remote DALI-2 (DT6) for Static White 0.1% dimming, 120-277V (22W, 50W or 100W)
- X = No Driver

Cover

- SRC = Square Recessed Cone
- SRPH = Square Regressed Pinhole (N/A with 36° Beam)

Lens

- OA = Open Aperture
- RSC = Recessed Satin Clear Lens

Beam

- 12 = 12° Beam Angle
- 25 = 25° Beam Angle
- 36 = 36° Beam Angle

Trim Finish

- W = White, 15% gloss, RAL 9003 (standard)
- B = Black, 15% gloss, RAL 9005
- S = Silver, 15% gloss, RAL 9006
- F = Custom finish, specify RAL code

Cover Finish

- W = White, 15% gloss, RAL 9003 (standard)
- B = Black, 15% gloss, RAL 9005
- S = Silver, 15% gloss, RAL 9006
- F = Custom finish, specify RAL code

Housing (optional)⁴

- LP = Landing Pan
- NC = New Construction Housing
- IC = Insulated Ceiling Housing
- CP = Chicago Plenum Housing
- X = No Housing

Options

- WL = Wet Location (only available with SRC)
- MLC = Multiple Luminaire Configurations (RPT only - see detail page)
- AS = Aim Stick
- ASL = Aim Stick w/ Laser
- HL = Honeycomb Louver (specify with OA)
- EM = Emergency (remote only)
- AWNRF = Lutron Athena Wireless Node RF (RS010, RD010, RD2S drivers only)

Whitegoods reserves the right to change any information without prior notice.

Notes

- Wattage shown does not include power supplies/drivers.
- Refer to photometric data sheet for delivered lumens.
- See driver information for details.
- See housings pages for details

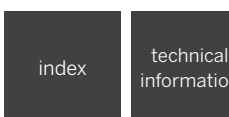

3" ProTools Wall Wash Round Recessed



3" round recessed wall washer with half moon regressed light aperture with flush kick reflector.

Housing	Die-caste aluminum for precision fit and heat dissipation Mounting hardware for all ceiling types; trim and trimless Quick-screw mounting mechanism EZ-Click Cover installation Trimless housing with Quick-Snap feature allows endless multiple combinations without specialized housings
Covers	RWW - Round Wall Wash with flush room-side cutoff and wall wash spread lens
LED	Constant Current, 92+ CRI (standard), 98 CRI / 95 CRI WD (optional), 2-Step MacAdam Low/Mid/High output choices (delivers up to 61 lumens per watt) 2700K, 3000K, 3500K, 4000K Tunable White (1800 - 4000K) Warm Dim (1800 - 3000K) L70 (TM21 Projected 85° C) Static White = 55,400 hours, TW + WD = 55,000 hours
Beam	WW Wall Wash
Driver	Integral and remote drivers for all dimming and non-dimming applications Through-wire integral driver enclosure installed from below without the need for bulky housing POE driver compatibility
Installation Housing	Not required when using the Driver Enclosure LP - Landing Pan NC - New Construction IC - Insulated Ceiling CP - Chicago Plenum
Warranty	5-year Limited (see complete company warranty information)
Certifications	ETL and ETL-C for dry and damp location, CE, Wet Location rated



RBT / RWW / WWL



RPT / RWW / WWL

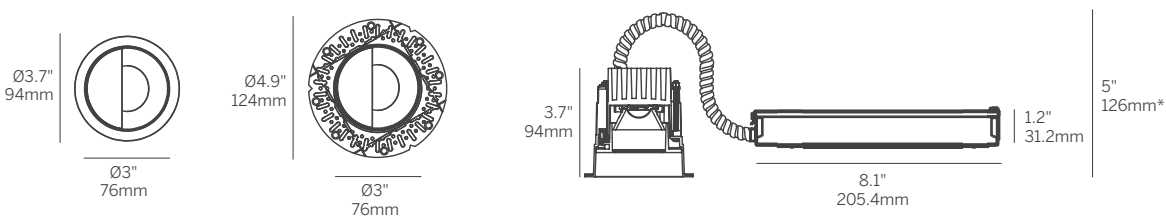

RBT / RWW

RPT / RWW

*Minimum of 5" (126mm) ceiling void is required to install the integral driver from below the ceiling.

3" ProTools Wall Wash Round Recessed

Model	Fixation	Power ¹	CRI	CCT ²	Driver ³	Cover	Lens	Beam	Trim Finish	Cover Finish	Options
WG-75RPTWW	RBT RPT	L M H TW WD	92 98 92 95	27 30 35 40 TW WD	S010 D010 SPH PEQ0 D2S RS010 RD010 RD2S RD2T	RWW	WWL	WW	W (std) S F	W (std) S F	WL MLC EM AWNRF

Model

- WG-75RPTWW = 3" ProTools Wall Wash Round Recessed

Fixation

- RBT = Recessed Bezel Trim
- RPT = Recessed Plaster Trim

Power¹

- L = Low Power, 5.7W @ 350mA
- M = Mid Power, 8.4W @ 500mA
- H = High Power, 12W @ 700mA
- TW = 9W @ 500mA
- WD = 11.8W @ 350mA

CRI

- 92 = 92 CRI (Static White, TW only)
- 98 = 98 CRI (Static White)
- 95 = 95 CRI (WD only)

CCT²

- 27 = 2700K
- 30 = 3000K
- 35 = 3500K
- 40 = 4000K
- TW = Tunable White 1800 - 4000K
- WD = Warm Dimming 1800 - 3000K

Integral Driver³

- S010 = eldoLED 0-10V 1% dimming, 120-277V (22W)
- D010 = eldoLED 0-10V 0.1% dimming, 120-277V (22W)
- SPH = Phase (2-wire) 3% dimming, 120V only (20W)
- PEQ0 = Lutron Hi-Lume Premier 0.1% EcoSystem dimming, 120-277V (20W)
- D2S = DALI-2 (DT6) for Static White 0.1% dimming, 120-277V (22W)

Remote Driver³

- RRS010 = Remote eldoLED 0-10V 1% dimming, 120-277V (22W, 50W, or 100W)
- RD010 = Remote eldoLED 0-10V 0.1% dimming, 120-277V (22W, 50W, or 100W)
- RD2S = Remote DALI-2 (DT6) for Static White 0.1% dimming, 120-277V (22W, 50W, or 100W)
- RD2T = Remote DALI-2 (DT8) for Tunable White 0.1% dimming, 120-277V (30W, 50W or 75W)
- X = No Driver

Cover

- RWW = Round Wall Wash

Lens

- WWL = Wall Wash Spread Lens

Beam

- WW = Wall Wash

Trim Finish

- W = White, 15% gloss, RAL 9003 (standard)
- S = Silver, 15% gloss, RAL 9006
- F = Custom finish, specify RAL code

Cover Finish

- W = White, 15% gloss, RAL 9003 (standard)
- S = Silver, 15% gloss, RAL 9006
- F = Custom finish, specify RAL code

Housing (optional)⁴

- LP = Landing Pan
- NC = New Construction Housing
- IC = Insulated Ceiling Housing
- CP = Chicago Plenum Housing
- X = No Housing

Options

- WL = Wet Location
- MLC = Multiple Luminaire Configurations (RPT only - see detail page)
- EM = Emergency (remote only)
- AWNRF = Lutron Athena Wireless Node RF (RS010, RD010, RD2S, RD2T drivers only)

Whitegoods reserves the right to change any information without prior notice.

Notes

- Wattage shown does not include power supplies/drivers.
- See photometric data sheet for delivered lumens.
- See driver information for details.
- See housings pages for details.

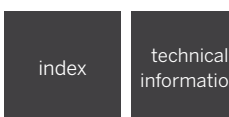

3" ProTools Wall Wash Square Recessed



3" square recessed wall washer with rectangular regressed light aperture with flush kick reflector.

Housing	Die-caste aluminum for precision fit and heat dissipation Mounting hardware for all ceiling types; trim and trimless Quick-screw mounting mechanism EZ-Click Cover installation Trimless housing with Multiple Luminaire Configurations feature allows endless multiple combinations without specialized housings
Covers	SWW - Square Wall Wash with flush room-side cutoff and wall wash spread lens
LED	Constant Current, 92+ CRI (standard), 98 CRI / 95 CRI WD (optional), 2-Step MacAdam Low/Mid/High output choices (delivers up to 57 lumens per watt) 2700K, 3000K, 3500K, 4000K Tunable White (1800 - 4000K) Warm Dim (1800 - 3000K) L70 (TM21 Projected 85° C) Static White = 55,400 hours TW + WD = 55,000 hours
Beam	WW - Wall wash provided with Satin spread lens
Driver	Integral and remote drivers for all dimming and non-dimming applications Non-Dim, 0-10V, Phase, Lutron and DALI driver options Through-wire integral driver enclosure installed from below without the need for bulky housing POE driver compatibility
Installation	Not required when using the Driver Enclosure
Housing	LP - Landing Pan NC - New Construction IC - Insulated Ceiling CP - Chicago Plenum
Warranty	5-year Limited (see complete company warranty information)
Certifications	ETL and ETL-C for dry and damp location (WL Wet Location optional), CE



RBT / SWW / WWL



RPT / SWW / WWL

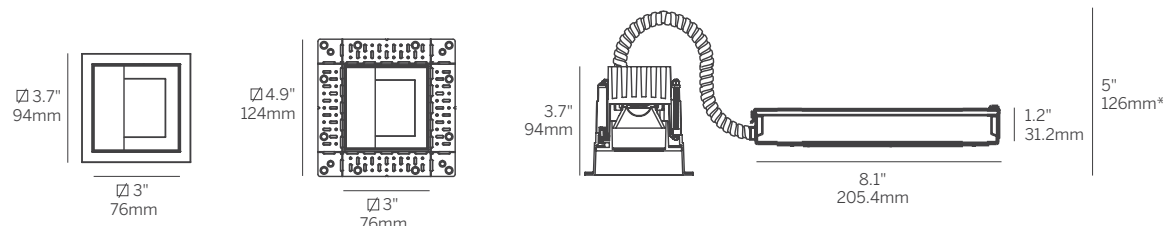

RBT / RWW

RPT / RWW

90 Whitegoods Downlights

*Minimum of 5" (126mm) ceiling void is required to install the integral driver from below the ceiling.

3" ProTools Wall Wash Square Recessed

Model	Fixation	Power ¹	CRI	CCT ²	Driver ³	Cover	Lens	Beam	Trim Finish	Cover Finish	Housing ⁴	Options
WG-75SPTWW	RBT RPT	L M H TW WD	92 98 92 95	27 30 35 40 TW WD	S010 D010 SPH PEQ0 D2S RS010 RD010 RD2S RD2T X	SWW	WWL	WW	W S F	W S F	LP NC IC CP X	WL MLC EM AWNRF

Model

- WG-75SPTWW = 3" ProTools Wall Wash Square Recessed

Fixation

- RBT = Recessed Bezel Trim
- RPT = Recessed Plaster Trim

Power¹

- L = Low Power, 5.7W @ 350mA
- M = Mid Power, 8.4W @ 500mA
- H = High Power, 12W @ 700mA
- TW = 9W @ 500mA
- WD = 11.8W @ 350mA

CRI

- 92 = 92 CRI (Static White, TW only)
- 98 = 98 CRI (Static White)
- 95 = 95 CRI (WD only)

CCT²

- 27 = 2700K
- 30 = 3000K
- 35 = 3500K
- 40 = 4000K
- TW = Tunable White 1800 - 4000K
- WD = Warm Dimming 1800 - 3000K

Integral Driver³

- S010 = eldoLED 0-10V 1% dimming, 120-277V (22W)
- D010 = eldoLED 0-10V 0.1% dimming, 120-277V (22W)
- SPH = Phase (2-wire) 3% dimming, 120V only (20W)
- PEQ0 = Lutron Hi-Lume Premier 0.1% EcoSystem dimming, 120-277V (20W)
- D2S = DALI-2 (DT6) for Static White 0.1% dimming, 120-277V (22W)

Remote Driver³

- RS010 = Remote eldoLED 0-10V 1% dimming, 120-277V (22W, 50W or 100W)
- RD010 = Remote eldoLED 0-10V 0.1% dimming, 120-277V (22W, 50W or 100W)
- RD2S = Remote DALI-2 (DT6) for Static White 0.1% dimming, 120-277V (22W, 50W or 100W)
- RD2T = Remote DALI-2 (DT8) for Tunable White 0.1% dimming, 120-277V (30W, 50W or 75W)
- X = No Driver

Cover

- SWW = Square Wall Wash

Lens

- WWL = Wall Wash Spread Lens

Beam

- WW = Wall Wash

Trim Finish

- W = White, 15% gloss, RAL 9003 (standard)
- S = Silver, 15% gloss, RAL 9006
- F = Custom finish, specify RAL code

Cover Finish

- W = White, 15% gloss, RAL 9003 (standard)
- S = Silver, 15% gloss, RAL 9006
- F = Custom finish, specify RAL code

Housing (optional)⁴

- LP = Landing Pan
- NC = New Construction Housing
- IC = Insulated Ceiling Housing
- CP = Chicago Plenum Housing
- X = No Housing

Options

- WL = Wet Location
- MLC = Multiple Luminaire Configurations (RPT only - see detail page)
- EM = Emergency (remote only)
- AWNRF = Lutron Athena Wireless Node RF (RS010, RD010, RD2S, RD2T drivers only)

Whitegoods reserves the right to change any information without prior notice.

Notes

- Wattage shown does not include power supplies/drivers.
- See photometric data sheet for delivered lumens.
- See driver information for details.
- See housings pages for details.

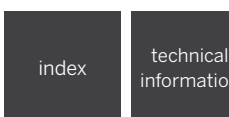

3" ProTools Accent Wall Wash Round Recessed



RBT / RAWW / MPO



RBT / RAWW / MPO

3" round recessed accent wall washer with regressed angled diffuser.

Housing	Die-caste aluminum for precision fit and heat dissipation Mounting hardware for all ceiling types; trim and trimless Spring mounting mechanism EZ-Click Cover installation Trimless housing with Multiple Luminaire Configurations feature allows endless multiple combinations without specialized housings
Covers	RAWW - Round Accent Wall Wash
LED	Constant Current, 92+ CRI (standard), 98 CRI / 95 CRI WD (optional), 2-Step MacAdam Low/Mid/High output choices (delivers up to 34 lumens per watt) 2700K, 3000K, 3500K, 4000K Tunable White (1800 - 4000K) Warm Dim (1800 - 3000K) L70 (TM21 Projected 85° C) Static White = 55,400 hours, TW + WD = 55,000 hours
Beam	Lambertian
Driver	Integral and remote drivers for all dimming and non-dimming applications Non-Dim, 0-10V, Phase, Lutron and DALI driver options Through-wire integral driver enclosure installed from below without the need for bulky housing POE driver compatibility
Installation Housing	Not required when using the Driver Enclosure LP - Landing Pan NC - New Construction IC - Insulated Ceiling CP - Chicago Plenum
Warranty	5-year Limited (see complete company warranty information)
Certifications	ETL and ETL-C for dry and damp location, CE

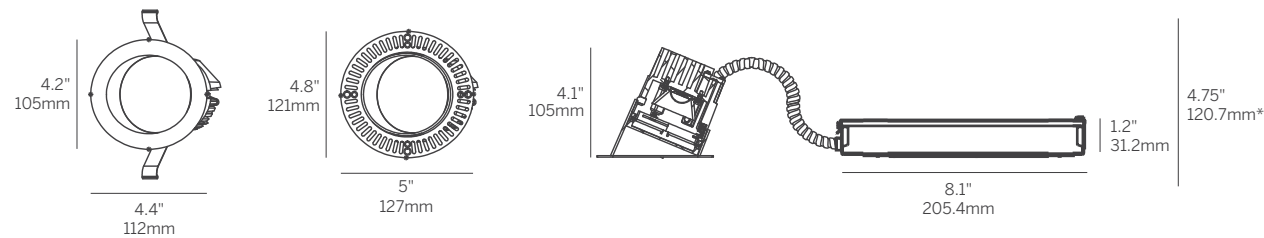

RBT / RAWW

RPT / RAWW

*Minimum of 4.75" (120.7mm) ceiling void is required to install the integral driver from below the ceiling.

3" ProTools Accent Wall Wash Round Recessed

Model	Fixation	Power ¹	CRI	CCT ²	Driver ³	Cover	Lens	Beam	Trim Finish	Housing ⁴	Options
WG-75RPTAWW	RBT RPT	L M H TW WD	92 98 92 95	27 30 35 40 TW WD	S010 D010 SPH PEQ0 D2S RS010 RD010 RD2S RD2T X	RAWW	MPO	LAM	W B S F	LP NC IC CP X	EM AWNRF

Model

- WG-75RPTAWW = 3" ProTools Accent Wall Wash Round Recessed

Fixation

- RBT = Recessed Bezel Trim
- RPT = Recessed Plaster Trim

Power¹

- L = Low Power, 5.7W @ 350mA
- M = Mid Power, 8.4W @ 500mA
- H = High Power, 12W @ 700mA
- TW = 9W @ 500mA
- WD = 11.8W @ 350mA

CRI

- 92 = 92 CRI (Static White, TW only)
- 98 = 98 CRI (Static White)
- 95 = 95 CRI (WD only)

CCT²

- 27 = 2700K
- 30 = 3000K
- 35 = 3500K
- 40 = 4000K
- TW = Tunable White 1800 - 4000K
- WD = Warm Dimming 1800 - 3000K

Integral Driver³

- S010 = eldoLED 0-10V 1% dimming, 120-277V (22W)
- D010 = eldoLED 0-10V 0.1% dimming, 120-277V (22W)
- SPH = Phase (2-wire) 3% dimming, 120V only (20W)
- PEQ0 = Lutron Hi-Lume Premier 0.1% EcoSystem dimming, 120-277V (20W)
- D2S = DALI-2 (DT6) for Static White 0.1% dimming, 120-277V (22W)

Remote Driver³

- RS010 = Remote eldoLED 0-10V 1% dimming, 120-277V (22W, 50W or 100W)
- RD010 = Remote eldoLED 0-10V 0.1% dimming, 120-277V (22W, 50W or 100W)
- RD2S = Remote DALI-2 (DT6) for Static White 0.1% dimming, 120-277V (22W, 50W or 100W)
- RD2T = Remote DALI-2 (DT8) for Tunable White 0.1% dimming, 120-277V (30W, 50W or 75W)
- X = No Driver

Cover

- RAWW = Round Accent Wall Wash

Lens

- MPO = Micro-Prismatic Opal diffuser

Beam

- LAM = Lambertian

Trim Finish

- W = White, 15% gloss, RAL 9003 (standard)
- B = Black, 15% gloss, RAL 9005
- S = Silver, 15% gloss, RAL 9006
- F = Custom finish, specify RAL code

Housing (optional)⁴

- LP = Landing Pan
- NC = New Construction Housing
- IC = Insulated Ceiling Housing
- CP = Chicago Plenum Housing
- X = No Housing

Options

- EM = Emergency LED battery backup available, ordered separately
- AWNRF = Lutron Athena Wireless Node RF (RS010, RD010, RD2S, RD2T drivers only)

Whitegoods reserves the right to change any information without prior notice.

Notes

- Wattage shown does not include power supplies/drivers.
- See photometric data sheet for delivered lumens.
- See driver information for details.
- See housings pages for details.

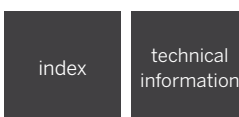

3" ProTools Accent Wall Wash Square Recessed



3" square recessed accent wall washer with regressed angled diffuser.

Housing	Die-cast aluminum for precision fit and heat dissipation Mounting hardware for all ceiling types; trim and trimless Spring mounting mechanism EZ-Click Cover installation Trimless housing with Multiple Luminaire Configurations feature allows endless multiple combinations without specialized housings
Covers	SAWW - Square Accent Wall Wash
LED	Constant Current, 92+ CRI (standard), 98 CRI / 95 CRI WD(optional), 2-Step MacAdam Low/Mid/High output choices (delivers up to 34 lumens per watt) 2700K, 3000K, 3500K, 4000K Tunable White (1800 - 4000K) Warm Dim (1800 - 3000K) L70 (TM21 Projected 85° C) Static White = 55,400 hours, TW + WD = 55,000 hours
Beam	Lambertian
Driver	Integral and remote drivers for all dimming and non-dimming applications Non-Dim, 0-10V, Phase, Lutron and DALI driver options Through-wire integral driver enclosure installed from below without the need for bulky housing POE driver compatibility
Installation Housing	Not required when using the Driver Enclosure LP - Landing Pan NC - New Construction IC - Insulated Ceiling CP - Chicago Plenum
Warranty	5-year Limited (see complete company warranty information)
Certifications	ETL and ETL-C for dry and damp location, CE

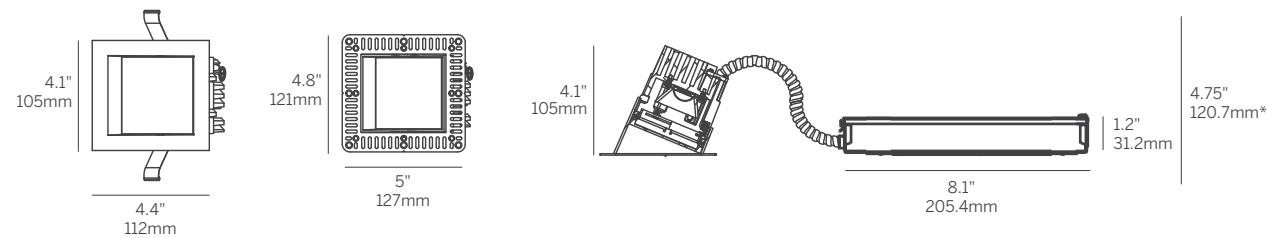

RBT / RAWW

RPT / RAWW

*Minimum of 4.75" (120.7mm) ceiling void is required to install the integral driver from below the ceiling.

3" ProTools Accent Wall Wash Square Recessed

Model	Fixation	Power ¹	CRI	CCT ²	Driver ³	Cover	Lens	Beam	Trim Finish	Housing ⁴	Options
WG-75SPTAWW	RBT RPT	L M H TW WD	92 98 92 95	27 30 35 40 TW WD	S010 D010 SPH PEQ0 D2S RS010 RD010 RD2S RD2T X	SAWW	MPO	LAM	W B S F	LP NC IC CP X	EM AWNRF



RBT / SAWW / MPO



RBT / SAWW / MPO

Model

- WG-75SPTAWW = 3" ProTools Accent Wall Wash Square Recessed

Fixation

- RBT = Recessed Bezel Trim
- RPT = Recessed Plaster Trim

Power¹

- L = Low Power, 5.7W @ 350mA
- M = Mid Power, 8.4W @ 500mA
- H = High Power, 12W @ 700mA
- TW = 9W @ 500mA
- WD = 11.8W @ 350mA

CRI

- 92 = 92 CRI (Static White, TW only)
- 98 = 98 CRI (Static White)
- 95 = 95 CRI (WD only)

CCT²

- 27 = 2700K
- 30 = 3000K
- 35 = 3500K
- 40 = 4000K
- TW = Tunable White 1800 - 4000K
- WD = Warm Dimming 1800 - 3000K

Integral Driver³

- S010 = eldoLED 0-10V 1% dimming, 120-277V (22W)
- D010 = eldoLED 0-10V 0.1% dimming, 120-277V (22W)
- SPH = Phase (2-wire) 3% dimming, 120V only (20W)
- PEQ0 = Lutron Hi-Lume Premier 0.1% EcoSystem dimming, 120-277V (20W)
- D2S = DALI-2 (DT6) for Static White 0.1% dimming, 120-277V (22W)

Remote Driver³

- RS010 = Remote eldoLED 0-10V 1% dimming, 120-277V (22W, 50W or 100W)
- RD010 = Remote eldoLED 0-10V 0.1% dimming, 120-277V (22W, 50W or 100W)
- RD2S = Remote DALI-2 (DT6) for Static White 0.1% dimming, 120-277V (22W, 50W or 100W)
- RD2T = Remote DALI-2 (DT8) for Tunable White 0.1% dimming, 120-277V (30W, 50W or 75W)
- X = No Driver

Cover

- SAWW = Square Accent Wall Wash

Lens

- MPO = Micro-Prismatic Opal diffuser

Beam

- LAM = Lambertian

Trim Finish

- W = White, 15% gloss, RAL 9003 (standard)
- B = Black, 15% gloss, RAL 9005
- S = Silver, 15% gloss, RAL 9006
- F = Custom finish, specify RAL code

Housing (optional)⁴

- LP = Landing Pan
- NC = New Construction Housing
- IC = Insulated Ceiling Housing
- CP = Chicago Plenum Housing
- X = No Housing

Options

- EM = Emergency LED battery backup available, ordered separately
- AWNRF = Lutron Athena Wireless Node RF (RS010, RD010, RD2S, RD2T drivers only)

Whitegoods reserves the right to change any information without prior notice.

Notes

- Wattage shown does not include power supplies/drivers.
- See photometric data sheet for delivered lumens.
- See driver information for details.
- See housings pages for details.

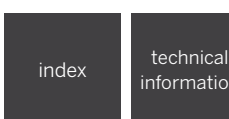

4" ProTools Downlights

4" ProTools Downlights family offers mid size, high performance fixed or adjustable downlights and wall washers with a variety of cover options in round or square, trimmed or trimless and multiple luminaire configurations. The fixtures are simple in nature, designed for superb glare control, modularity and include Whitegoods attention to seamless integration with surrounding materials.

- Downlight (Shallow)
- Downlight
- Wall Wash
- Adjustable
- Wet Location

Application guide
Product details

28-31
104-119



4" ProTools Range Logic

The ProTools range allows the specifier freedom to design for all spaces and environments within a project from one succinct, logical and aesthetically congruent range of luminaires. The comprehensive options cover all of the designer's needs.

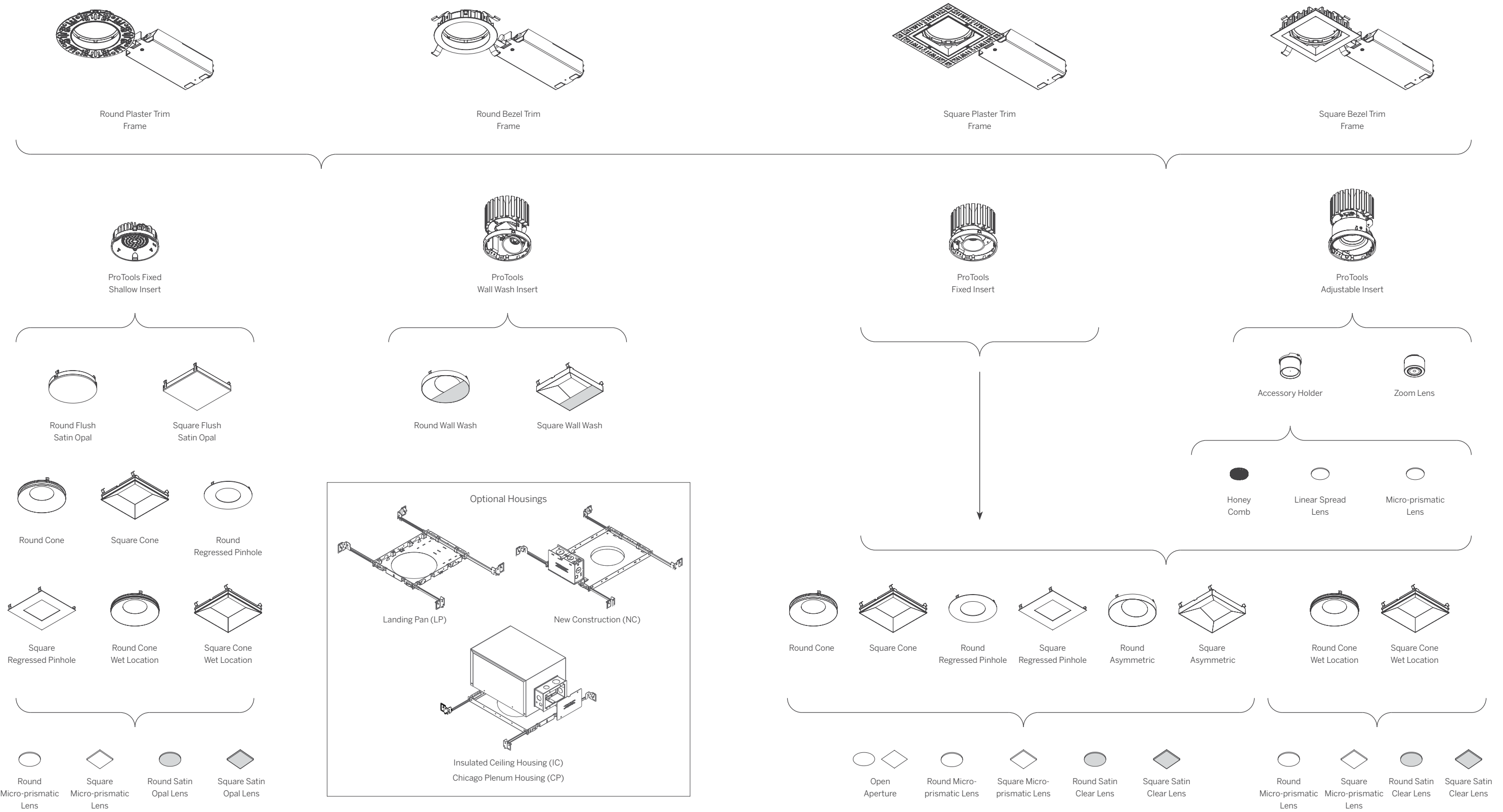

4" ProTools ease of Installation

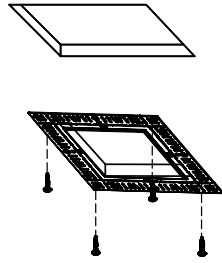

Cut a hole in the ceiling and clear insulation. Insert Frame into ceiling and secure with at least 4 drywall Screws.

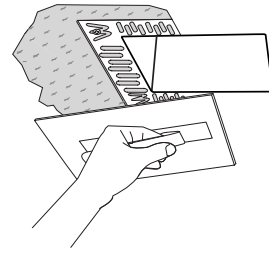

Install using 'tape-and-joint' method, or plaster finish. Clean excess plaster while still wet.

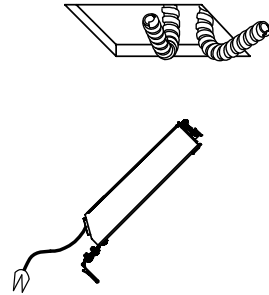

Pull power cable and control cable through the ceiling opening and make connections.

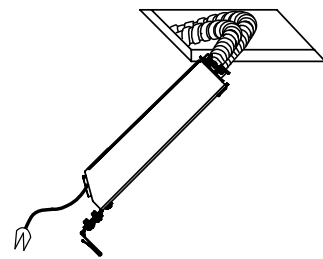

Push the Driver Box through the Housing. Insert the tab from the Driver into one of the slots located on the Housing.

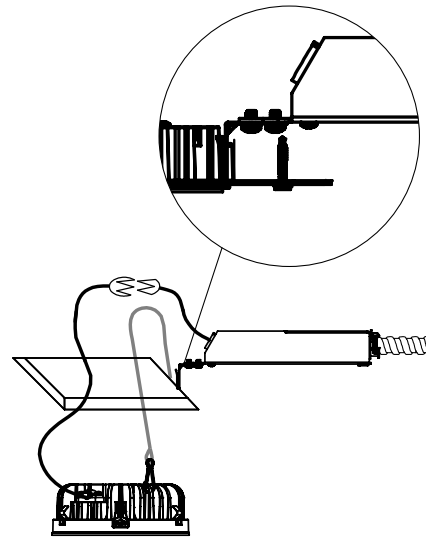

Attach the Safety Cable and make the electrical connection between the Driver and the Light Engine.

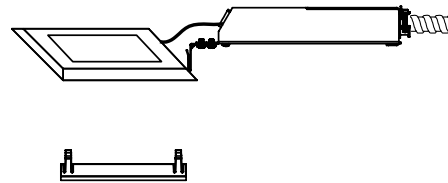

Push the Diffuser into Light Engine locking it into place.

4" ProTools Multiple Luminaire Configurations

Multiple fixture configurations can be accomplished using standard plaster-trim Downlight Frames.

With ProTools 4" Downlights you never have to purchase a specialized housing in order to realize a multiple configuration. In fact, you can simply snap off segments of the plaster-trim on standard product and field join the Frames during installation.

You simply specify the standard product.

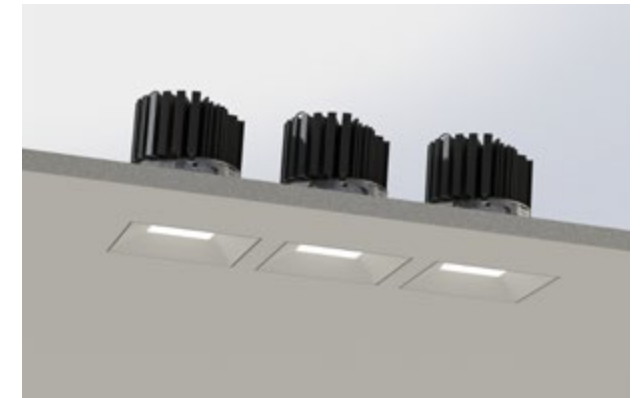
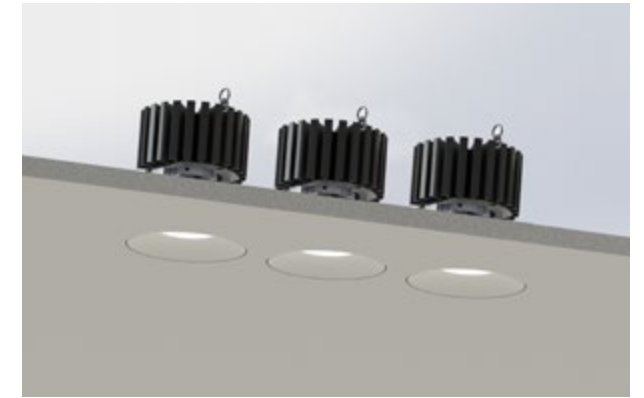

① Select which side of the plaster trim to remove.

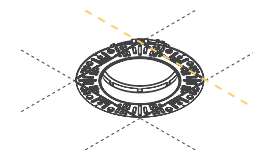

④ ...to create "multiple" configurations, which would usually require additional dedicated housings.

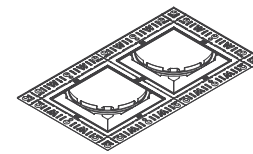

② Use a pair of multi-grip pliers and firmly snap off the trim with one swift movement.



⑤ Any number of frames can be grouped together to form linear configurations.

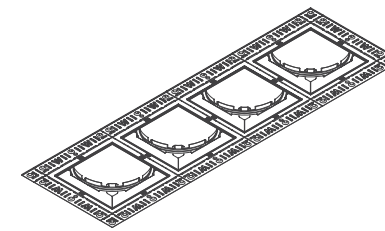

③ Installation frames can now be fixed directly next to one another...

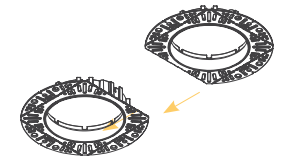



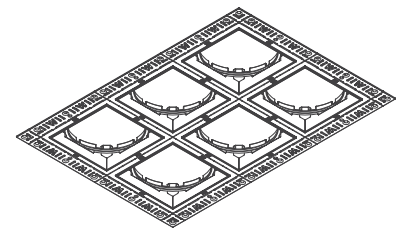

⑥ There are really no limits to the ways in which the installation frames can be combined.





4" ProTools Downlights



Fixed Downlights

	4" ProTools Downlight (Shallow) Round Recessed	104
	4" ProTools Downlight (Shallow) Square Recessed	106
	4" ProTools Downlight Round Recessed	108
	4" ProTools Downlight Square Recessed	110

Washlights

	4" ProTools Wall Wash Round Recessed	116
	4" ProTools Wall Wash Square Recessed	118

Adjustable Downlights

	4" ProTools Adjustable Round Recessed	112
	4" ProTools Adjustable Square Recessed	114



4" ProTools Downlight (Shallow) Round Recessed



4" round aperture downlight for wide distribution general illumination. Available with round recessed cone or regressed pinhole with 0.5" regressed 2" round light aperture or high transmission, evenly illuminated flush full aperture diffuser.

Housing	Die-caste aluminum for precision fit and heat dissipation Mounting hardware for all ceiling types; trim and trimless EZ clip mounting for secure installation Trimless housing with Multiple Luminaire Configurations feature allows endless multiple combinations without specialized housings
Covers	RFD - Round Flush Diffuser for high angle diffuse illumination RRC - Round Recessed Cone for low brightness, general illumination RRP - Round Regressed Pinhole offers the smallest aperture and maximum glare control
LED	Constant Current Control, 92+ CRI, 3-Step MacAdam Low/Mid/High output choices (delivers up to 77 lumens per watt) 2700K, 3000K, 3500K, 4000 L70 (TM21 Projected 85° C) Static White = 102,000 hours
Beam	Lambertian or 110° beam spread
Driver	Integral drivers for all dimming and non-dimming applications Non-Dim, 0-10V, Phase, Lutron and DALI driver options Through-wire integral driver enclosure installed from below without the need for bulky housing POE driver compatibility
Installation	Not required when using the Driver Enclosure
Housing	LP - Landing Pan NC - New Construction IC - Insulated Ceiling CP - Chicago Plenum
Warranty	5-year Limited (see complete company warranty information)
Certifications	ETL and ETL-C for dry and damp location, (WL Wet Location optional), CE

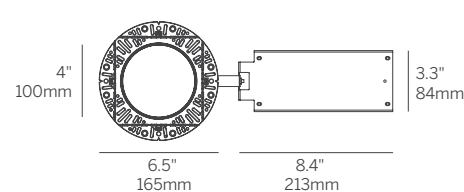

RPT / FRD

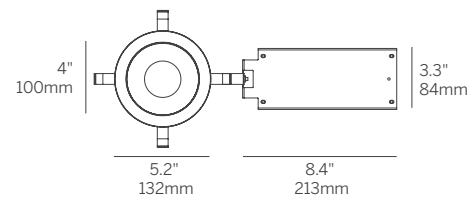

RBT / RRC

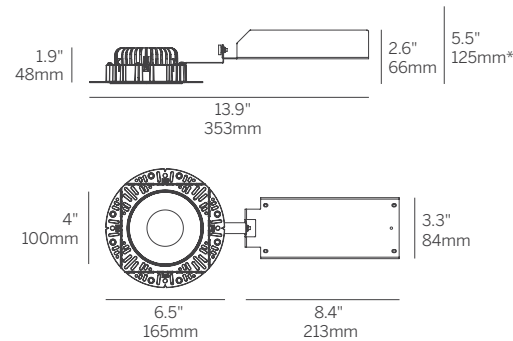

RPT / RRP



RPT / RFD / SOD



RBT / RRC / RSC



RPT / RRP / RSC

4" ProTools Downlight (Shallow) Round Recessed

Model	Fixation	Power ¹	CRI	CCT ²	Driver ³	Cover	Lens	Beam	Trim Finish	Cover Finish	Housing ⁴	Options
WG-100RPTD	RPT RBT	L M H	92	27 30 35 40	S010 D010 SPH PEQ0 D2S	RFD	SOD	LAM	W B S F	W B S F	LP NC IC CP X	WL TC MLC EM
						RRC RRP	RSC	110				

Model

- WG-100RPTD = 4" ProTools Downlight (Shallow) Round Recessed

Fixation

- RPT = Recessed Plaster Trim
- RBT = Recessed Bezel Trim

Power¹

- L = Low Power, 11W @ 350mA
- M = Mid Power, 15W @ 500mA
- H = High Power, 22.5W @ 700mA

CRI

- 92 = 92+ CRI

CCT²

- 27 = 2700K
- 30 = 3000K
- 35 = 3500K
- 40 = 4000K

Driver³

- S010 = eldoLED 0-10V 1% dimming, 120-277V (30W)
- D010 = eldoLED 0-10V 0.1% dimming, 120-277V (30W)
- SPH = Phase (2-wire) 3% dimming, 120V only (20W)
- PEQ0 = Lutron Hi-Lume Premier 0.1% EcoSystem dimming, 120-277V (20W) [N/A for High Power]
- D2S = DALI-2 (DT6) for Static White 0.1% dimming, 120-277V (30W)

Cover

- RFD = Round Flush Diffuser
- RRC = Round Recessed Cone
- RRP = Round Regressed Pinhole

Lens

- SOD = Satin Opal Diffuser
- RSC = Recessed Satin Clear Lens

Beam

- LAM = Lambertian
- 110 = 110° Beam Angle

Trim / Cover Finish (N/A for SFD)

- W = White, 15% gloss, RAL 9003 (standard)
- B = Black, 15% gloss, RAL 9005
- S = Silver, 15% gloss, RAL 9006
- F = Custom finish, specify RAL code

Housing (optional)⁴

- LP = Landing Pan
- NC = New Construction Housing
- IC = Insulated Ceiling Housing
- CP = Chicago Plenum Housing
- X = No Housing

Options

- WL = Wet Location (RRC only)
- TC = Thick Ceiling Clip (see detail page)
- MLC = Multiple luminaire configurations (see detail page)
- EM = Emergency (remote only)

Whitegoods reserves the right to change any information without prior notice.

Notes

- Wattage shown does not include power supplies/drivers.
- See photometric data sheet for delivered lumens.
- See driver information for details.
- See housings pages for details.

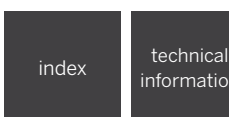

4" ProTools Downlight (Shallow) Square Recessed



4" square aperture downlight for wide distribution general illumination. Available with square recessed cone or regressed pinhole with 0.5" regressed 2" square light aperture or high transmission, evenly illuminated flush full aperture diffuser.

Housing	Die-caste aluminum for precision fit and heat dissipation Mounting hardware for all ceiling types; trim and trimless EZ clip mounting for secure installation Trimless housing with Multiple Luminaire Configurations feature allows endless multiple combinations without specialized housings
Covers	SFD - Square Flush Diffuser for high angle diffuse illumination SRC - Square Recessed Cone for low brightness, general illumination SRP - Square Regressed Pinhole offers the smallest aperture and maximum glare control
LED	Constant Current Control, 92+ CRI, 3-Step MacAdam Low/Mid/High output choices (delivers up to 77 lumens per watt) 2700K, 3000K, 3500K, 4000 L70 (TM21 Projected 85° C) Static White = 102,000 hours
Beam	Lambertian or 110° beam spread
Driver	Integral drivers for all dimming and non-dimming applications Non-Dim, 0-10V, Phase, Lutron and DALI driver options Through-wire integral driver enclosure installed from below without the need for bulky housing POE driver compatibility
Installation	Not required when using the Driver Enclosure
Housing	LP - Landing Pan NC - New Construction IC - Insulated Ceiling CP - Chicago Plenum
Warranty	5-year Limited (see complete company warranty information)
Certifications	ETL and ETL-C for dry and damp location, (WL Wet Location optional), CE

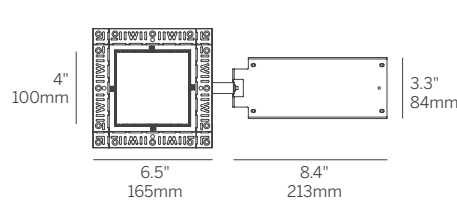

RPT / SFD

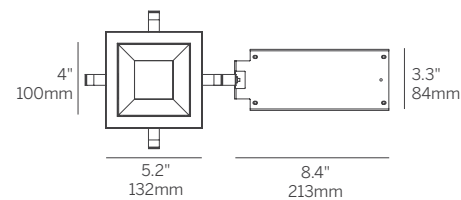

RBT / SRC



RPT / SFD / SOD



RBT / SRC / RSC

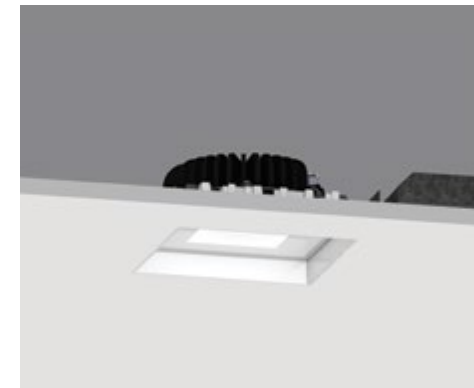

RPT / SRP / RSC

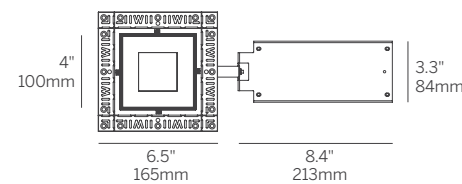
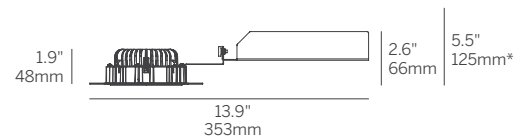

RPT / SRP

4" ProTools Downlight (Shallow) Square Recessed

Model	Fixation	Power ¹	CRI	CCT ²	Driver ³	Cover	Lens	Beam	Trim Finish	Cover Finish	Housing ⁴	Options
WG-100SPTD	RPT RBT	L M H	92	27 30 35 40	S010 D010 SPH PEQ0 D2S	SFD	SOD	LAM	W B S F	W B S F	LP NC IC CP X	WL TC WC MLC EM
						SRC SRP	RSC	110				

Model

- WG-100SPTD = 4" ProTools Downlight (Shallow) Square Recessed

Fixation

- RPT = Recessed Plaster Trim
- RBT = Recessed Bezel Trim

Power¹

- L = Low Power, 11W @ 350mA
- M = Mid Power, 15W @ 500mA
- H = High Power, 22.5W @ 700mA

CRI

- 92 = 92+ CRI

CCT²

- 27 = 2700K
- 30 = 3000K
- 35 = 3500K
- 40 = 4000K

Driver³

- S010 = eldoLED 0-10V 1% dimming, 120-277V (30W)
- D010 = eldoLED 0-10V 0.1% dimming, 120-277V (30W)
- SPH = Phase (2-wire) 3% dimming, 120V only (20W) [N/A for H power]
- PEQ0 = Lutron Hi-Lume Premier 0.1% EcoSystem dimming, 120-277V (20W) [N/A for High Power]
- D2S = DALI-2 (DT6) for Static White 0.1% dimming, 120-277V (30W)

Cover

- SFD = Square Flush Diffuser
- SRC = Square Recessed Cone
- SRP = Square Regressed Pinhole

Lens

- SOD = Satin Opal Diffuser
- RSC = Recessed Satin Clear Lens

Beam

- LAM = Lambertian
- 110 = 110° Beam Angle

Trim / Cover Finish (Cover N/A for SFD)

- W = White, 15% gloss, RAL 9003 (standard)
- B = Black, 15% gloss, RAL 9005
- S = Silver, 15% gloss, RAL 9006
- F = Custom finish, specify RAL code

Housing (optional)⁴

- LP = Landing Pan
- NC = New Construction Housing
- IC = Insulated Ceiling Housing
- CP = Chicago Plenum Housing
- X = No Housing

Options

- WL = Wet Location (SRC only)
- TC = Thick Ceiling Clip (see detail page)
- WC = Wood Ceiling Adapter (RPT only - specify ceiling thickness)
- MLC = Multiple luminaire configurations (see detail page)
- EM = Emergency (remote only)

Whitegoods reserves the right to change any information without prior notice.

Notes

- Wattage shown does not include power supplies/drivers.
- See photometric data sheet for delivered lumens.
- See driver information for details.
- See housings pages for details.

index

technical
information



4" ProTools Downlight Round Recessed



4" round aperture downlight for general illumination. Available with round recessed cone or regressed pinhole with 0.5" regressed 2" round light aperture.

Housing	Die-caste aluminum for precision fit and heat dissipation Mounting hardware for all ceiling types; trim and trimless EZ clip mounting for secure installation Trimless housing with Multiple Luminaire Configurations feature allows endless multiple combinations without specialized housings
Covers	RRC - Round Recessed Cone for low brightness, general illumination RRP - Round Regressed Pinhole offers the smallest aperture and maximum glare control
LED	Constant Current Control, 92+ CRI (standard), 98+ CRI (optional), 2-Step MacAdam Low/Mid/High/Extra High output choices (delivers up to 67 lumens per watt) 2700K, 3000K, 3500K, 4000K Tunable White (1800 - 4000K) Warm Dim (1800 - 3000K) L70 (TM21 Projected 85° C) Static White = 55,400 hours TW + WD = 55,000 hours
Beam	16°, 32°, 41°, 65° beam spreads
Driver	Integral drivers for all dimming and non-dimming applications Non-Dim, 0-10V, Phase, Lutron and DALI driver options Through-wire integral driver enclosure installed from below without the need for bulky housing POE driver compatibility
Installation Housing	Not required when using the Driver Enclosure LP - Landing Pan NC - New Construction IC - Insulated Ceiling CP - Chicago Plenum
Warranty	5-year Limited (see complete company warranty information)
Certifications	ETL and ETL-C for dry and damp location (WL Wet Location optional), CE

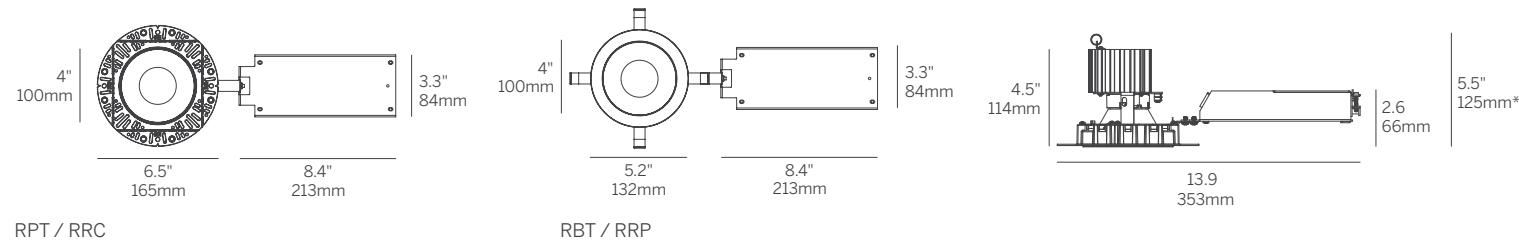

RPT / RRC

RBT / RRP

4" ProTools Downlight Round Recessed

Model	Fixation	Power ¹	CRI	CCT ²	Driver ³	Cover	Lens	Beam	Trim Finish	Cover Finish	Housing ⁴	Options	
WG-100SPTDLF	RPT RBT	L	92	27	S010	RRC	OA	16	W	W	LP	WL	
		M	98	30	D010	RRP	MPL	32	B	B	NC	TC	
		H		35	SPH		RSC	41	S	S	IC	MLC	
		XH		40	PEQO			65	F	F	CP	EM	
		TW	92	TW	D2S						X		
		WD	95	WD	D2T								



RPT / RRC / MPL

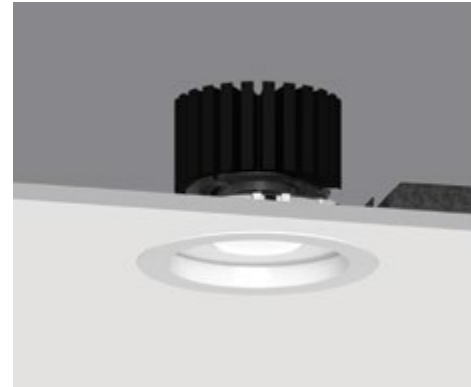

RBT / RRP / RSC

Model

- WG-100RPTDLF = 4" ProTools Downlight Round Recessed

Fixation

- RPT = Recessed Plaster Trim
- RBT = Recessed Bezel Trim

Power¹

- L = Low Power, 5.7W @ 350mA
- M = Mid Power, 8.4W @ 500mA
- H = High Power, 12W @ 700mA
- XH = Extra High Power, 17.8W @ 1050mA
- TW = 9W @ 500mA
- WD = 0.4 - 11.8W @ 350mA

CRI

- 92 = 92 CRI (Static White, TW only)
- 98 = 98 CRI (Static White)
- 95 = 95 CRI (WD only)

CCT²

- 27 = 2700K
- 30 = 3000K
- 35 = 3500K
- 40 = 4000K
- TW = Tunable White 1800 - 4000K
- WD = Warm Dimming 1800 - 3000K

Driver³

- S010 = eldoLED 0-10V 1% dimming, 120-277V (30W)
- D010 = eldoLED 0-10V 0.1% dimming, 120-277V (30W)
- SPH = Phase (2-wire) 3% dimming, 120V only (20W) [n/a for XH power]
- PEQO = Lutron Hi-Lume Premier 0.1% EcoSystem dimming, 120-277V (20W)
- D2S = DALI-2 (DT6) for Static White 0.1% dimming, 120-277V (30W)
- D2T = DALI-2 (DT8) for Tunable White 0.1% dimming, 120-277V (30W)

Cover

- RRC = Round Recessed Cone
- RRP = Round Regressed Pinhole

Lens

- OA = Open Aperture
- MPL = Micro-prismatic Lens
- RSC = Recessed Satin Clear Lens

Beam

- 16 = 16° Beam Angle
- 32 = 32° Beam Angle
- 41 = 41° Beam Angle
- 65 = 65° Beam Angle

Trim / Cover Finish

- W = White, 15% gloss, RAL 9003 (standard)
- B = Black, 15% gloss, RAL 9005
- S = Silver, 15% gloss, RAL 9006
- F = Custom finish, specify RAL code

Housing (optional)⁴

- LP = Landing Pan
- NC = New Construction Housing
- IC = Insulated Ceiling Housing
- CP = Chicago Plenum Housing
- X = No Housing

Options

- WL = Wet Location (SRC only)
- TC = Thick Ceiling Clip (see detail page)
- MLC = Multiple luminaire configurations (see detail page)
- EM = Emergency LED battery backup available, ordered separately

Whitegoods reserves the right to change any information without prior notice.

Notes

- Wattage shown does not include power supplies/drivers.
- See photometric data sheet for delivered lumens.
- See driver information for details.
- See housings pages for details.

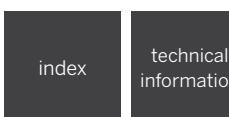

4" ProTools Downlight Square Recessed



4" square aperture downlight for general illumination. Available with square recessed cone or regressed pinhole with 0.5" regressed 2" square light aperture.

Housing	Die-caste aluminum for precision fit and heat dissipation Mounting hardware for all ceiling types; trim and trimless EZ clip mounting for secure installation Trimless housing with Multiple Luminaire Configurations feature allows endless multiple combinations without specialized housings
Covers	SRC - Square Recessed Cone for low brightness, general illumination SRP - Square Regressed Pinhole offers the smallest aperture and maximum glare control
LED	Constant Current Control, 92+ CRI (standard), 98+ CRI (optional), 2-Step MacAdam Low/Mid/High/Extra High output choices (delivers up to 76 lumens per watt) 2700K, 3000K, 3500K, 4000K Tunable White (1800 - 4000K) Warm Dim (1800 - 3000K) L70 (TM21 Projected 85° C) Static White = 55,400 hours TW + WD = 55,000 hours
Beam	16°, 32°, 41°, 65° beam spreads
Driver	Integral drivers for all dimming and non-dimming applications Non-Dim, 0-10V, Phase, Lutron and DALI driver options Through-wire integral driver enclosure installed from below without the need for bulky housing POE driver compatibility
Installation Housing	Not required when using the Driver Enclosure LP - Landing Pan NC - New Construction IC - Insulated Ceiling CP - Chicago Plenum
Warranty	5-year Limited (see complete company warranty information)
Certifications	ETL and ETL-C for dry and damp location (WL Wet Location optional), CE

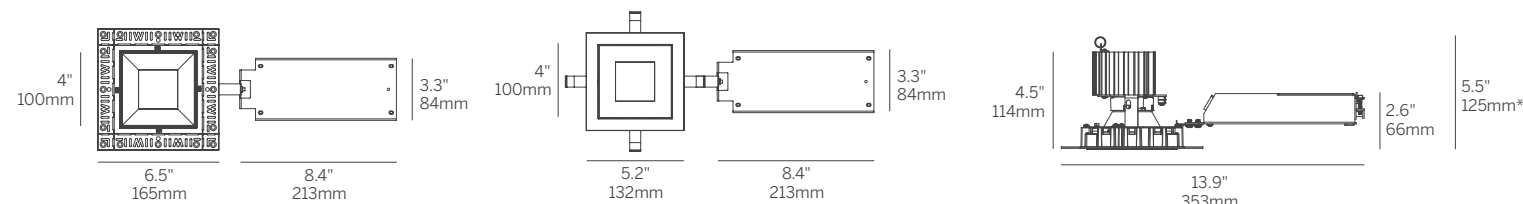

RPT / SRC

RBT / SRP

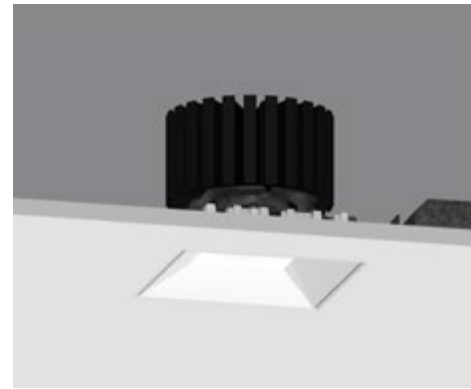

RPT / SRC / MPL



RBT / SRP / RSC

4" ProTools Downlight Square Recessed

Model	Fixation	Power ¹	CRI	CCT ²	Driver ³	Cover	Lens	Beam	Trim Finish	Cover Finish	Housing ⁴	Options
WG-100SPTDLF	RPT RBT	L	92	27	S010	SRC	OA	16	W	W	LP	WL
		M	98	30	D010	SRP	MPL	32	B	B	NC	TC
		H		35	SPH		RSC	41	S	S	IC	WC
		XH		40	PEQO			65	F	F	CP	MLC
		TW	92	TW	D2S						X	EM
		WD	95	WD	D2T							

Model

- WG-100SPTDLF = 4" ProTools Downlight Square Recessed

Fixation

- RPT = Recessed Plaster Trim
- RBT = Recessed Bezel Trim

Power¹

- L = Low Power, 5.7W @ 350mA
- M = Mid Power, 8.4W @ 500mA
- H = High Power, 12W @ 700mA
- XH = Extra High Power, 17.8W @ 1050mA
- TW = 9W @ 500mA
- WD = 0.4 - 11.8W @ 350mA

CRI

- 92 = 92 CRI (Static White, TW only)
- 98 = 98 CRI (Static White)
- 95 = 95 CRI (WD only)

CCT²

- 27 = 2700K
- 30 = 3000K
- 35 = 3500K
- 40 = 4000K
- TW = Tunable White 1800 - 4000K
- WD = Warm Dimming 1800 - 3000K

Driver³

- S010 = eldoLED 0-10V 1% dimming, 120-277V (30W)
- D010 = eldoLED 0-10V 0.1% dimming, 120-277V (30W)
- SPH = Phase (2-wire) 3% dimming, 120V only (20W) [n/a for XH power]
- PEQO = Lutron Hi-Lume Premier 0.1% EcoSystem dimming, 120-277V (20W)
- D2S = DALI-2 (DT6) for Static White 0.1% dimming, 120-277V (30W)
- D2T = DALI-2 (DT8) for Tunable White 0.1% dimming, 120-277V (30W)

Cover

- SRC = Square Recessed Cone
- SRP = Square Regressed Pinhole

Lens

- OA = Open Aperture
- MPL = Micro-prismatic Lens
- RSC = Recessed Satin Clear Lens

Beam

- 16 = 16° Beam Angle
- 32 = 32° Beam Angle
- 41 = 41° Beam Angle
- 65 = 65° Beam Angle

Trim / Cover Finish

- W = White, 15% gloss, RAL 9003 (standard)
- B = Black, 15% gloss, RAL 9005
- S = Silver, 15% gloss, RAL 9006
- F = Custom finish, specify RAL code

Housing (optional)⁴

- LP = Landing Pan
- NC = New Construction Housing
- IC = Insulated Ceiling Housing
- CP = Chicago Plenum Housing
- X = No Housing

Options

- WL = Wet Location (SRC only)
- TC = Thick Ceiling Clip (see detail page)
- WC = Wood Ceiling Adapter (specify ceiling thickness)
- MLC = Multiple luminaire configurations (see detail page)
- EM = Emergency LED battery backup available, ordered separately

Whitegoods reserves the right to change any information without prior notice.

Notes

- Wattage shown does not include power supplies/drivers.
- See photometric data sheet for delivered lumens.
- See driver information for details.
- See housings pages for details.

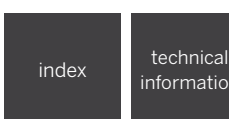

4" ProTools Adjustable Round Recessed



4" round aperture adjustable downlight for general and accent illumination. Available with round recessed cone, regressed pinhole or asymmetric cone with 0.5" regressed 2" round light aperture. Tilt 40°, rotation 365°, 144 step.

Housing	Die-caste aluminum for precision fit and heat dissipation Mounting hardware for all ceiling types; trim and trimless EZ clip mounting for secure installation Trimless housing with Multiple Luminaire Configuration feature allows endless multiple combinations without specialized housings
Covers	RRC - Round Recessed Cone for low brightness, general illumination RRP - Round Regressed Pinhole for smallest aperture, maximum glare control RAC - Round Asymmetric Cone for minimal ceiling interruption and maximum tilt
LED	Constant Current, 92+ CRI (standard), 98+ CRI (optional), 2-Step MacAdam Low/Mid/High/Extra High output choices (delivers up to 74 lumens per watt) 2700K, 3000K, 3500K, 4000K Tunable White (1800 - 4000K) Warm Dim (1800 - 3000K) L70 (TM21 Projected 85°C) Static White = 55,400 hours TW + WD = 55,000 hours 8° (Narrow) = 109,000 hours
Beam	16°, 32°, 41° beam spreads 8° Narrow beam spread (TIR Optic) 18-36° Adjustable (Zoom) beam spread (TIR Optic)
Driver	Integral drivers for all dimming and non-dimming applications Non-Dlm, 0-10V, Phase, Lutron and DALI driver options. Through-wire integral driver enclosure installed from Through-wire integral driver enclosure installed from below without the need for bulky housing POE driver compatibility
Installation Housing	Not required when using the Driver Enclosure LP - Landing Pan NC - New Construction IC - Insulated Ceiling CP - Chicago Plenum
Warranty	5-year Limited (see complete company warranty information)
Certifications	ETL and ETL-C for dry and damp location, CE

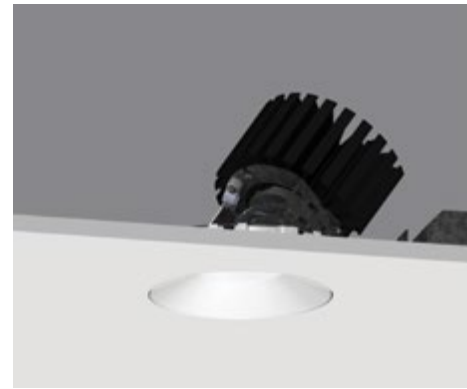
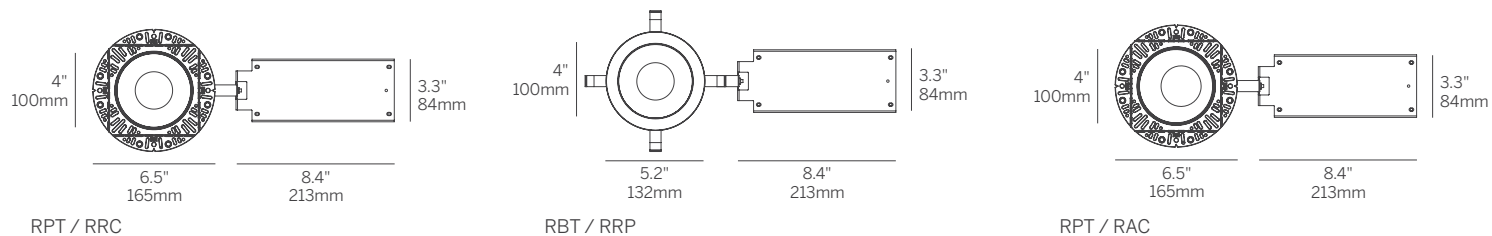

RPT / RRC / MPL

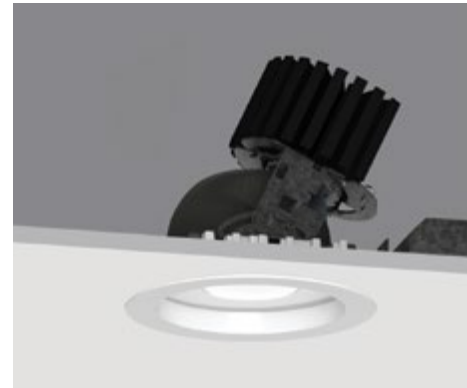

RBT / RRP / MPL



RPT / RAC / MPL

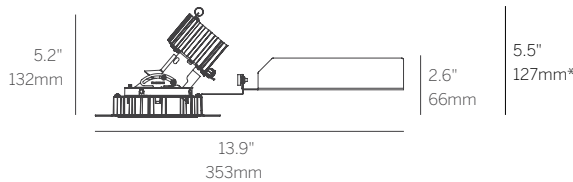

4" ProTools Adjustable Round Recessed

Model	Fixation	Power ¹	CRI	CCT ²	Driver ³	Cover	Lens	Beam	Trim Finish	Cover Finish	Housing ⁴	Options
WG-100RPTDLX	RPT RBT	L	92	27	S010	RRC	OA	16	W	W	LP	SOL
		M	98	30	D010	RRP	MPL	32	B	B	NC	LSL
		H		35	SPH	RAC	RSC	41	S	S	IC	HL
		XH		40	PEQO			8 (Narrow)	F	F	CP	TC
		TW	92	TW	D2S			18-36 (Zoom)			X	MLC
		WD	95	WD	D2T							AS ASL EM

Model

- WG-100RPTDLX = 4" ProTools Adjustable Round Recessed

Fixation

- RPT = Recessed Plaster Trim
- RBT = Recessed Bezel Trim

Power¹

- L = Low Power, 5.7W @ 350mA (3.9W for 8° Narrow)
- M = Mid Power, 8.4W @ 500mA (5.8W for 8° Narrow)
- H = High Power, 12W @ 700mA (8.3W for 8° Narrow)
- XH = Extra High Power, 18.6W @ 1050mA (13.1W for 8° Narrow)
- TW = 9W @ 500mA
- WD = 0.4 - 11.8W @ 350mA

CRI

- 92 = 92 CRI (Static White, TW only)
- 98 = 98 CRI (Static White)
- 95 = 95 CRI (WD only)

CCT²

- 27 = 2700K
- 30 = 3000K
- 35 = 3500K
- 40 = 4000K
- TW = Tunable White 1800 - 4000K
- WD = Warm Dimming 1800 - 3000K

Driver³

- S010 = eldoLED 0-10V 1% dimming, 120-277V (30W)
- D010 = eldoLED 0-10V 0.1% dimming, 120-277V (30W)
- SPH = Phase (2-wire) 3% dimming, 120V only (20W)
- PEQO = Lutron Hi-Lume Premier 0.1% EcoSystem dimming, 120-277V (20W)
- D2S = DALI-2 (DT6) for Static White 0.1% dimming, 120-277V (30W)
- D2T = DALI-2 (DT8) for Tunable White 0.1% dimming, 120-277V (30W)

Cover

- RRC = Round Recessed Cone
- RRP = Round Regressed Pinhole
- RAC = Round Asymmetric Cone

Lens

- OA = Open Aperture
- MPL = Micro-prismatic Lens
- RSC = Recessed Satin Clear Lens

Beam

- 16 = 16° Beam Angle
- 32 = 32° Beam Angle
- 41 = 41° Beam Angle
- 8 = 8° Beam Angle (Narrow) (TIR Optic) (N/A for TW / WD)
- 18-36 = 18-36° Beam Angle (Zoom) (TIR Optic) (OA only) (N/A for TW / WD)

Trim / Cover Finish

- W = White, 15% gloss, RAL 9003 (standard)
- B = Black, 15% gloss, RAL 9005
- S = Silver, 15% gloss, RAL 9006
- F = Custom finish, specify RAL code

Housing (optional)⁴

- LP = Landing Pan
- NC = New Construction Housing
- IC = Insulated Ceiling Housing
- CP = Chicago Plenum Housing
- X = No Housing

Options

- SOL = Solite Lens
- LSL = Linear Spread Lens
- HL = Honeycomb Louver
- TC = Thick Ceiling Clip (see detail page)
- MLC = Multiple luminaire configurations (see detail page)
- AS = Aim stick
- ASL = Aim Stick w/ Laser
- EM = Emergency (remote only)

Whitegoods reserves the right to change any information without prior notice.

Notes

- Wattage shown does not include power supplies/drivers.
- See photometric data sheet for delivered lumens.
- See driver information for details.
- See housings pages for details.

4" ProTools Adjustable Square Recessed



4" square aperture adjustable downlight for general and accent illumination. Available with square recessed cone, regressed pinhole or asymmetric cone with 0.5" regressed 2" square light aperture. Tilt 40°, rotation 365°, 144 step.

Housing	Die-cast aluminum for precision fit and heat dissipation Mounting hardware for all ceiling types; trim and trimless EZ clip mounting for secure installation Trimless housing with Multiple Luminaire Configuration feature allows endless multiple combinations without specialized housings
Covers	SRC - Square Recessed Cone for low brightness, general illumination SRP - Square Regressed Pinhole for smallest aperture, maximum glare control SAC - Square Asymmetric Cone for minimal ceiling interruption and maximum tilt
LED	Constant Current, 92+ CRI (standard), 98+ CRI (optional), 2-Step MacAdam Low/Mid/High/Extra High output choices (delivers up to 76 lumens per watt) 2700K, 3000K, 3500K, 4000K Tunable White (1800 - 4000K) Warm Dim (1800 - 3000K) L70 (TM21 Projected 85°C) Static White = 55,400 hours TW + WD = 55,000 hours 8° (Narrow) = 109,000 hours
Beam	16°, 32°, 41° beam spreads 8° Narrow beam spread (TIR Optic) 18-36° Adjustable (Zoom) beam spread (TIR Optic)
Driver	Integral drivers for all dimming and non-dimming applications Non-Dim, 0-10V, Phase, Lutron and DALI driver options. Through-wire integral driver enclosure installed from below without the need for bulky housing POE driver compatibility
Installation Housing	Not required when using the Driver Enclosure LP - Landing Pan NC - New Construction IC - Insulated Ceiling CP - Chicago Plenum
Warranty	5-year Limited (see complete company warranty information)
Certifications	ETL and ETL-C for dry and damp location, CE

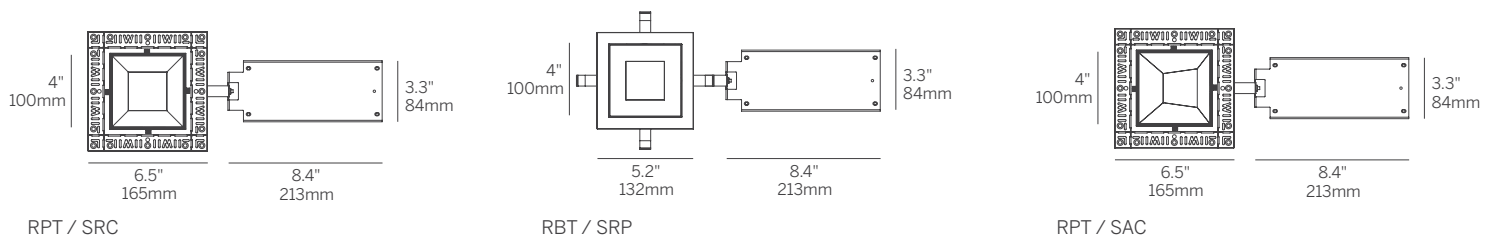

RPT / SRC

RBT / SRP

RPT / SAC

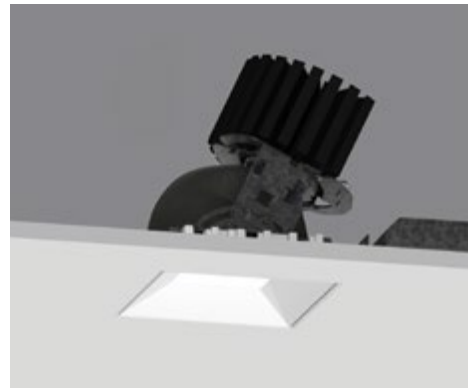

RPT / SRC / MPL



RBT / SRP / MPL

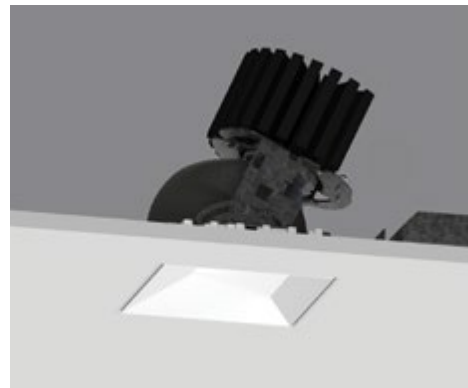

RPT / SAC / MPL

4" ProTools Adjustable Square Recessed

Model	Fixation	Power ¹	CRI	CCT ²	Driver ³	Cover	Lens	Beam	Trim Finish	Cover Finish	Housing ⁴	Options	
WG-100SPTDLX	RPT RBT	L	92	27	S010	SRC	OA	16	W	W	LP	SOL	
		M	98	30	D010	SRP	MPL	32	B	B	NC	LSL	
		H		35	SPH	SAC	RSC	41	S	S	IC	HL	
		XH		40	PEQO			8 (Narrow)	F	F	CP	TC	
		TW	92	TW	D2S			18-36 (Zoom)			X	MLC	
		WD	95	WD	D2T							AS	
													ASL
													EM

Model

- WG-100SPTDLX = 4" ProTools Adjustable Square Recessed

Fixation

- RPT = Recessed Plaster Trim
- RBT = Recessed Bezel Trim

Power¹

- L = Low Power, 5.7W @ 350mA (3.9W for 8° Narrow)
- M = Mid Power, 8.4W @ 500mA (5.8W for 8° Narrow)
- H = High Power, 12W @ 700mA (8.3W for 8° Narrow)
- XH = Extra High Power, 18.6W @ 1050mA (13.1W for 8° Narrow)
- TW = 9W @ 500mA
- WD = 0.4 - 11.8W @ 350mA

CRI

- 92 = 92 CRI (Static White, TW only)
- 98 = 98 CRI (Static White)
- 95 = 95 CRI (WD only)

CCT²

- 27 = 2700K
- 30 = 3000K
- 35 = 3500K
- 40 = 4000K
- TW = Tunable White 1800 - 4000K
- WD = Warm Dimming 1800 - 3000K

Driver³

- S010 = eldoLED 0-10V 1% dimming, 120-277V (30W)
- D010 = eldoLED 0-10V 0.1% dimming, 120-277V (30W)
- SPH = Phase (2-wire) 3% dimming, 120V only (20W)
- PEQO = Lutron Hi-Lume Premier 0.1% EcoSystem dimming, 120-277V (20W)
- D2S = DALI-2 (DT6) for Static White 0.1% dimming, 120-277V (30W)
- D2T = DALI-2 (DT8) for Tunable White 0.1% dimming, 120-277V (30W)

Cover

- SRC = Square Recessed Cone
- SRP = Square Regressed Pinhole
- SAC = Square Asymmetric Cone

Lens

- OA = Open Aperture
- MPL = Micro-prismatic Lens
- RSC = Recessed Satin Clear Lens

Beam

- 16 = 16° Beam Angle
- 32 = 32° Beam Angle
- 41 = 41° Beam Angle
- 8 = 8° Beam Angle (Narrow) (TIR Optic) (N/A for TW / WD)
- 18-36 = 18-36° Beam Angle (Zoom) (TIR Optic) (OA only) (N/A for TW / WD)

Trim / Cover Finish

- W = White, 15% gloss, RAL 9003 (standard)
- B = Black, 15% gloss, RAL 9005
- S = Silver, 15% gloss, RAL 9006
- F = Custom finish, specify RAL code

Housing (optional)⁴

- LP = Landing Pan
- NC = New Construction Housing
- IC = Insulated Ceiling Housing
- CP = Chicago Plenum Housing
- X = No Housing

Options

- SOL = Solite Lens
- LSL = Linear Spread Lens
- HL = Honeycomb Louver
- TC = Thick Ceiling Clip (see detail page)
- MLC = Multiple luminaire configurations (see detail page)
- AS = Aim stick
- ASL = Aim Stick w/ Laser
- EM = Emergency (remote only)

Whitegoods reserves the right to change any information without prior notice.

Notes

- Wattage shown does not include power supplies/drivers.
- See photometric data sheet for delivered lumens.
- See driver information for details.
- See housings pages for details.

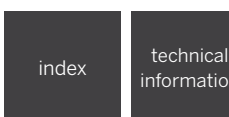

4" ProTools Wall Wash Round Recessed



4" round recessed wall washer with half moon regressed light aperture and flush kick reflector.

Housing	Die-cast aluminum for precision fit and heat dissipation Mounting hardware for all ceiling types; trim and trimless EZ clip mounting for secure installation Trimless housing with Multiple Luminaire Configurations feature allows endless multiple combinations without specialized housings
Covers	RWW - Round Wall Wash with room-side cutoff and wall wash distribution
LED	Constant Current, 92+ CRI (standard), 98+ CRI (optional), 2-Step MacAdam Low/Mid/High/Extra High output choices (delivers up to 41 lumens per watt) 2700K, 3000K, 3500K, 4000K Tunable White (1800 - 4000K) Warm Dim (1800 - 3000K) L70 (TM21 Projected 85° C) Static White = 55,400 hours TW + Warm Dim = 55,000 hours
Beam	WW - Wall wash provided with Satin spread lens (TIR Optic)
Driver	Integral drivers for all dimming and non-dimming applications Non-Dim, 0-10V, Phase, Lutron and DALI driver options. Through-wire integral driver enclosure installed from Through-wire integral driver enclosure installed from below without the need for bulky housing POE driver compatibility
Installation Housing	Not required when using the Driver Enclosure LP - Landing Pan NC - New Construction IC - Insulated Ceiling CP - Chicago Plenum
Warranty	5-year Limited (see complete company warranty information)
Certifications	ETL and ETL-C for dry and damp location (WL Wet Location optional), CE

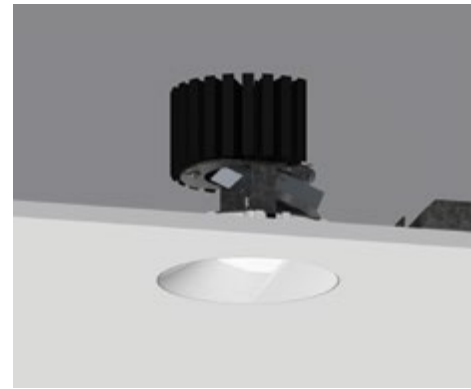

RPT

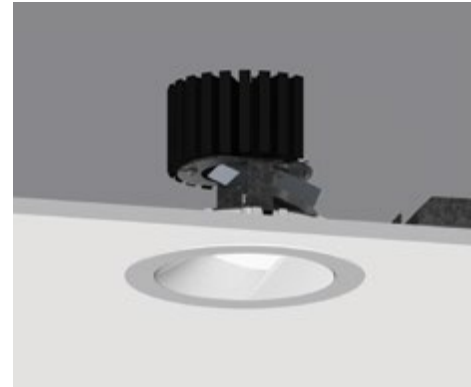

RBT

4" ProTools Wall Wash Round Recessed

Model	Fixation	Power ¹	CRI	CCT ²	Driver ³	Cover	Lens	Beam	Trim Finish	Cover Finish	Housing ⁴	Options
WG-100RPTDLWW	RPT RBT	L M H XH TW WD	92 98	27 30 35 40 TW WD	S010 D010 SPH PEQ0 D2S D2T	RWW	WWL	WW	W S F	W S F	LP NC IC CP X	WL TC MLC EM

Model

- WG-100RPTDLWW = 4" ProTools Wall Wash Round Recessed

Fixation

- RPT = Recessed Plaster Trim
- RBT = Recessed Bezel Trim

Power¹

- L = Low Power, 5.7W @ 350mA
- M = Mid Power, 8.4W @ 500mA
- H = High Power, 12W @ 700mA
- XH = Extra High Power, 17.8W @ 1050mA
- TW = 9W @ 500mA
- WD = 0.4 - 11.8W @ 350mA

CRI

- 92 = 92 CRI (Static White, TW only)
- 98 = 98 CRI (Static White)
- 95 = 95 CRI (WD only)

CCT²

- 27 = 2700K
- 30 = 3000K
- 35 = 3500K
- 40 = 4000K
- TW = Tunable White 1800 - 4000K
- WD = Warm Dimming 1800 - 3000K

Driver³

- S010 = eldoLED 0-10V 1% dimming, 120-277V (30W)
- D010 = eldoLED 0-10V 0.1% dimming, 120-277V (30W)
- SPH = Phase (2-wire) 3% dimming, 120V only (20W)
- PEQ0 = Lutron Hi-Lume Premier 0.1% EcoSystem dimming, 120-277V (20W)
- D2S = DALI-2 (DT6) for Static White 0.1% dimming, 120-277V (30W)
- D2T = DALI-2 (DT8) for Tunable White 0.1% dimming, 120-277V (30W)

Cover

- RWW = Round Wall Wash

Lens

- WWL = Wall Wash Spread Lens

Beam

- WW = Wall Wash

Trim / Cover Finish

- W = White, 15% gloss, RAL 9003 (standard)
- S = Silver, 15% gloss, RAL 9006
- F = Custom finish, specify RAL code

Housing (optional)⁴

- LP = Landing Pan
- NC = New Construction Housing
- IC = Insulated Ceiling Housing
- CP = Chicago Plenum Housing
- X = No Housing

Options

- WL = Wet Location
- TC = Thick Ceiling Clip (see detail page)
- MLC = Multiple luminaire configurations (see detail page)
- EM = Emergency LED battery backup available, ordered separately

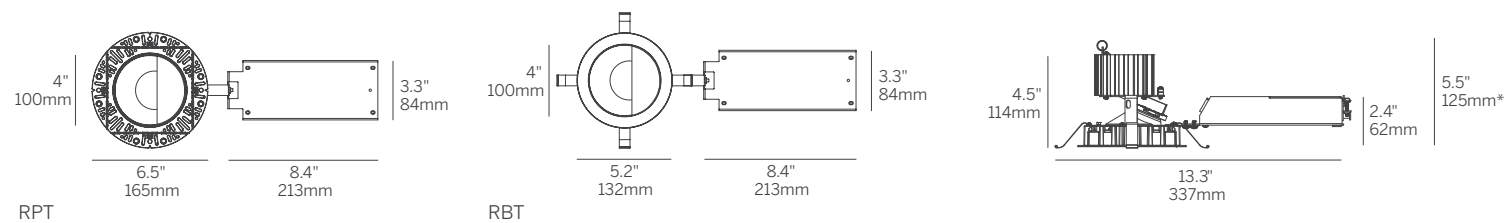

Whitegoods reserves the right to change any information without prior notice.

Notes

- Wattage shown does not include power supplies/drivers.
- See photometric data sheet for delivered lumens.
- See driver information for details.
- See housings pages for details.

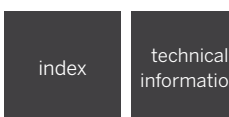

4" ProTools Wall Wash Square Recessed

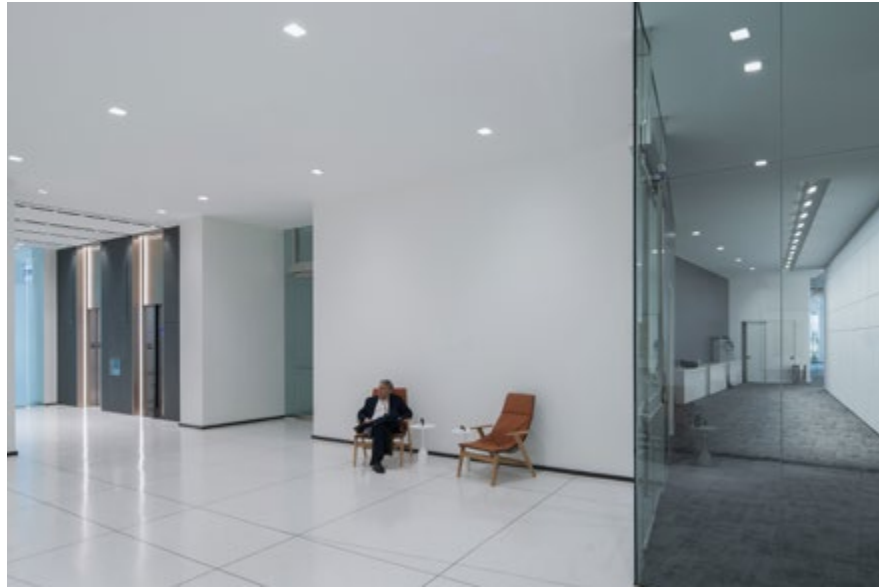

4" square recessed wall washer with rectangular regressed light aperture and flush kick reflector.

Housing	Die-caste aluminum for precision fit and heat dissipation Mounting hardware for all ceiling types; trim and trimless EZ clip mounting for secure installation Trimless housing with Multiple Luminaire Configurations feature allows endless multiple combinations without specialized housings
Covers	SWW - Square Wall Wash with room-side cutoff and wall wash distribution
LED	Constant Current, 92+ CRI (standard), 98+ CRI (optional), 2-Step MacAdam Low/Mid/High/Extra High output choices (delivers up to 49 lumens per watt) 2700K, 3000K, 3500K, 4000K Tunable White (1800 - 4000K) Warm Dim (1800 - 3000K) L70 (TM21 Projected 85° C) Static White = 55,400 hours TW + Warm Dim = 55,000 hours
Beam	WW - Wall wash provided with Satin spread lens (TIR Optic)
Driver	Integral drivers for all dimming and non-dimming applications Non-Dim, 0-10V, Phase, Lutron and DALI driver options. Through-wire integral driver enclosure installed from Through-wire integral driver enclosure installed from below without the need for bulky housing POE driver compatibility
Installation Housing	Not required when using the Driver Enclosure LP - Landing Pan NC - New Construction IC - Insulated Ceiling CP - Chicago Plenum
Warranty	5-year Limited (see complete company warranty information)
Certifications	ETL and ETL-C for dry and damp location (WL Wet Location optional), CE

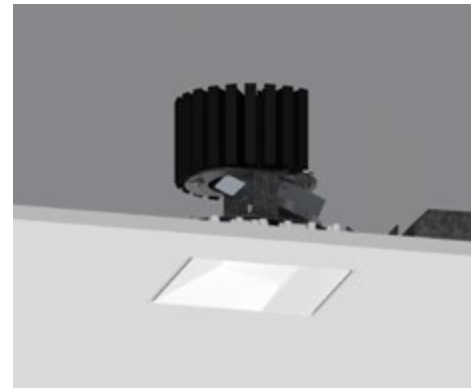

RPT

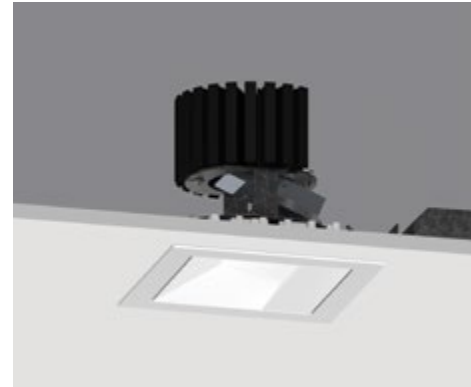

RBT

4" ProTools Wall Wash Square Recessed

Model	Fixation	Power ¹	CRI	CCT ²	Driver ³	Cover	Lens	Beam	Trim Finish	Cover Finish	Housing ⁴	Options
WG-100SPTDLWW	RPT RBT	L M H XH TW WD	92 98	27 30 35 40 TW WD	S010 D010 SPH PEQ0 D2S D2T	SWW	WWL	WW	W S F	W S F	LP NC IC CP X	WL TC MLC EM

Model

- WG-100SPTDLWW = 4" ProTools Wall Wash Square Recessed

Fixation

- RPT = Recessed Plaster Trim
- RBT = Recessed Bezel Trim

Power¹

- L = Low Power, 5.7W @ 350mA
- M = Mid Power, 8.4W @ 500mA
- H = High Power, 12W @ 700mA
- XH = Extra High Power, 17.8W @ 1050mA
- TW = 9W @ 500mA
- WD = 0.4 - 11.8W @ 350mA

CRI

- 92 = 92 CRI (Static White, TW only)
- 98 = 98 CRI (Static White)
- 95 = 95 CRI (WD only)

CCT²

- 27 = 2700K
- 30 = 3000K
- 35 = 3500K
- 40 = 4000K
- TW = Tunable White 1800 - 4000K
- WD = Warm Dimming 1800 - 3000K

Driver³

- S010 = eldoLED 0-10V 1% dimming, 120-277V (30W)
- D010 = eldoLED 0-10V 0.1% dimming, 120-277V (30W)
- SPH = Phase (2-wire) 3% dimming, 120V only (20W)
- PEQ0 = Lutron Hi-Lume Premier 0.1% EcoSystem dimming, 120-277V (20W)
- D2S = DALI-2 (DT6) for Static White 0.1% dimming, 120-277V (30W)
- D2T = DALI-2 (DT8) for Tunable White 0.1% dimming, 120-277V (30W)

Cover

- SWW = Square Wall Wash

Lens

- WWL = Wall Wash Spread Lens

Beam

- WW = Wall Wash

Trim / Cover Finish

- W = White, 15% gloss, RAL 9003 (standard)
- S = Silver, 15% gloss, RAL 9006
- F = Custom finish, specify RAL code

Housing (optional)⁴

- LP = Landing Pan
- NC = New Construction Housing
- IC = Insulated Ceiling Housing
- CP = Chicago Plenum Housing
- X = No Housing

Options

- WL = Wet Location
- TC = Thick Ceiling Clip (see detail page)
- MLC = Multiple luminaire configurations (see detail page)
- EM = Emergency LED battery backup available, ordered separately

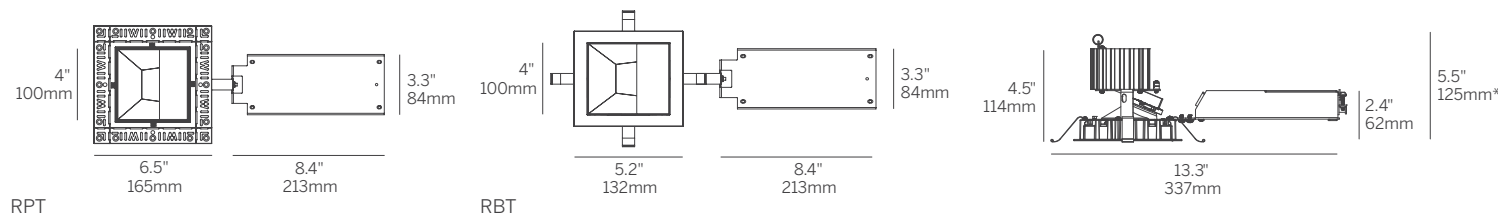

Whitegoods reserves the right to change any information without prior notice.

Notes

- 1 Wattage shown does not include power supplies/drivers.
- 2 See photometric data sheet for delivered lumens.
- 3 See driver information for details.
- 4 See housings pages for details.

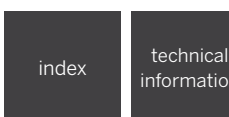

ProTools Cylinders

ProTools Cylinders are a complete family of cylinder downlights for surface, suspended and wall mounted applications. 2.4", 4" and 5.5" cylinders with wide range of beam angles, lens options and wall wash available to fit a multitude of applications.

- Downlight Cylinder
- Wall Mount Cylinder
- Wall Wash Cylinder
- Wet Location

Application guide
Product details

28-31
130-147





ProTools Cylinders



A complete Family of Cylinders

- A complete family of cylinder downlights for surface, suspended and wall mounted applications.
- 2.4", 4" and 5.5" cylinders with wide range of beam angles, lens options and wall wash available to fit a multitude of applications.
- High lumen output and excellent color rendition for all applications.
- UGR < 19 for some configurations to comply with WELL requirements.
- WL Wet Location (IP65) optional on some models.
- 92+ CRI, 2 step MacAdam Ellipse LEDs standard for Static White and Warm Dim (1800K - 3000K). 95+ CRI optional or Static White.
- Long life L70 55,000 hrs based on LM-80 & TM-21 applicable test data.
- Flicker-free constant current drivers.
- 0-10V, Phase, Lutron, DALI and DMX dimming options available.
- 5 Year warranty.







ProTools Cylinders

2.4" Cylinders

-  2.4" ProTools Downlight Round Cylinder 130
-  2.4" ProTools Downlight Round Cylinder Tall 132
-  2.4" ProTools Downlight Round Cylinder 134

4" Cylinders

-  4" ProTools Downlight Round Cylinder 136
-  4" ProTools Downlight Square Dark Cylinder 138
-  4" ProTools Wall Wash Round Cylinder 140
-  4" ProTools Wall Wash Square Cylinder 142
-  4" ProTools Downlight Round Cylinder Wall Mount 144

5" Cylinders

-  5.5" ProTools Downlight Round Cylinder 146

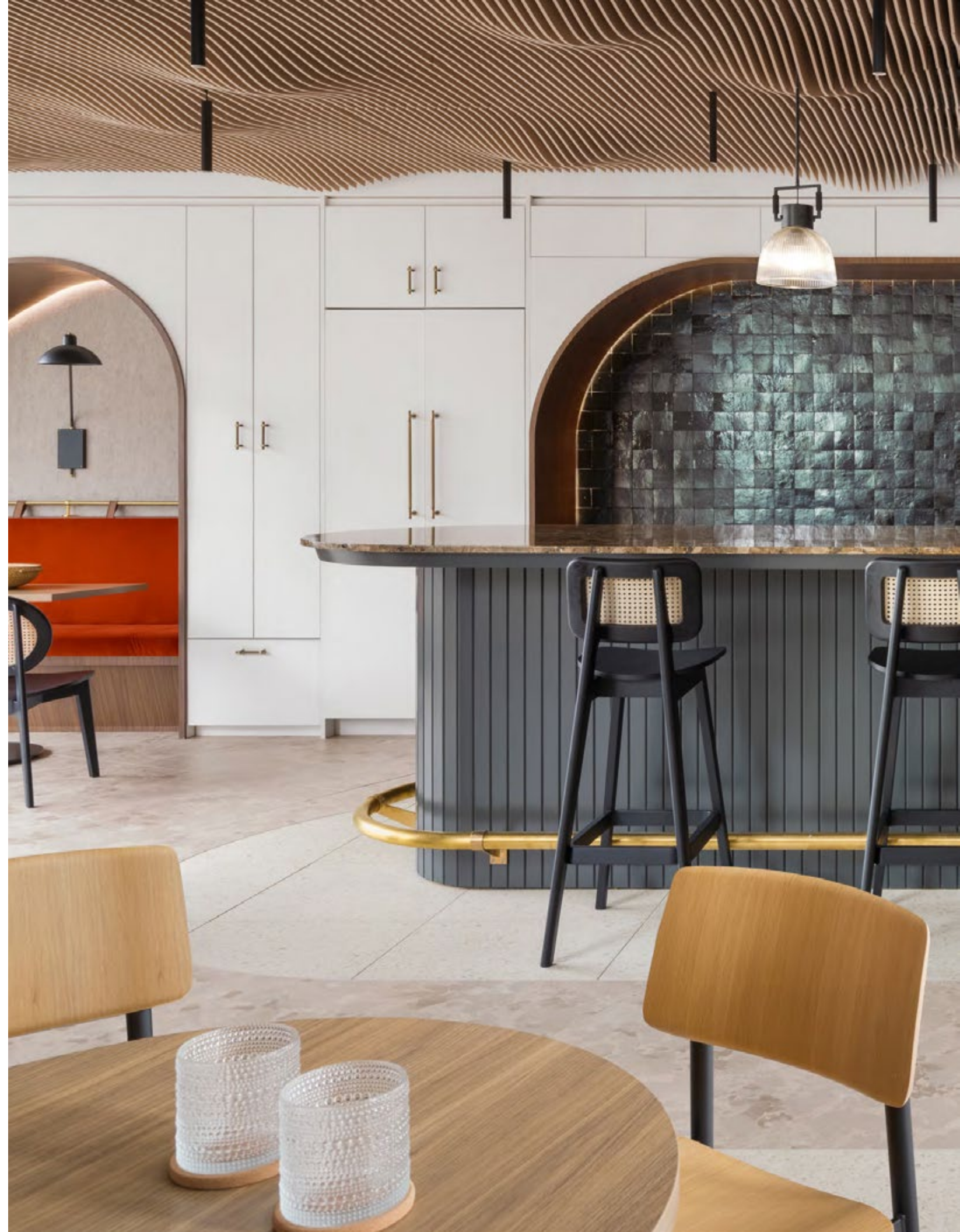



2.4" ProTools Downlight Round Cylinder



2.4" round ceiling mounted cylinder downlight with 1.6" diameter regressed light aperture.

Luminaire	Die-caste aluminum for precision fit and heat dissipation Mounting hardware for all ceiling types; surface and suspended Round open aperture with minimal ceiling interruption and regressed optical chamber Finishes: White, Black, Silver and custom (housing and reflector)
Mounting	SM - Surface Mount SC - Suspended Cable (field adjustable) SR - Suspended Rigid swivel stem 5" dia. for mounting to 4" j-box
Cover	RRC - Round Recessed Cone for low brightness, general illumination
LED	Constant Current, 92+ CRI (standard), 98+ CRI (optional), 2-Step MacAdam Low/Mid/High output choices (delivers up to 140 lumens per watt) 2700K, 3000K, 3500K, 4000K Warm Dim (1800 - 3000K) L70 (TM21 Projected 85°C) Static White + Warm Dim = 55,000 hours
Lens	OA - Open Aperture SOL - Solite Lens LSL - Linear Spread Lens HL - Honeycomb Louver
Beam	15°, 20°, 25°, 35°, 50°
Driver	Remote drivers for all dimming and non-dimming applications 0-10V, Phase, Lutron and DALI driver options POE driver compatibility
Warranty	5-year Limited (see complete company warranty information)
Certifications	ETL and ETL-C for dry and damp location, WL Wet Location (IP65) optional

Canopy (5" dia, 4" j-box)

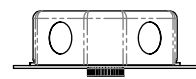

Ø5.1"
129.5mm



Surface mount (SM)

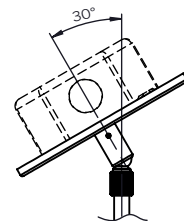
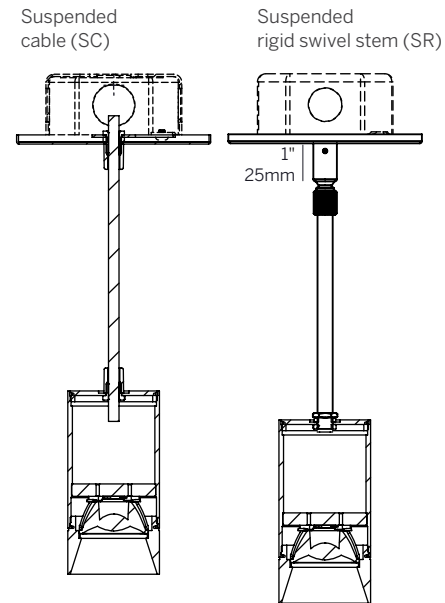
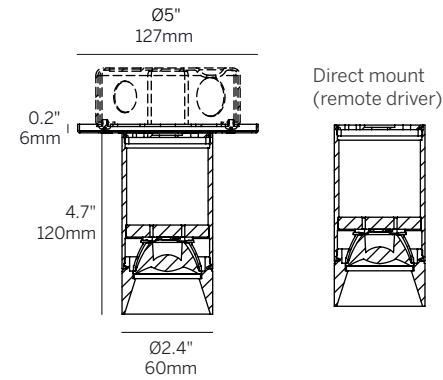

2.4" ProTools Downlight Round Cylinder

Model	Mounting	Canopy	Power ²	CRI	CCT ³	Driver ⁴	Cover	Lens	Beam	Finish ⁶	Options
WG-60RPTDL	SM SC1 ¹ SC2 ¹ SC3 ¹ SR1 SR2 SR3 SRX	5 X	L M H	92 98	27 30 35 40 WD	RS010 RD010 RSPH RPEQ0 RD2S X	RRC	OA SOL LSL HL	15 20 25 35 50	W (std) B S F	EM WL AWNRF

Model

- WG-60RPTDL = 2.4" ProTools Downlight Round Cylinder

Mounting

- SM = Surface mounted
- SC1 = Suspended cable 39.4" (1m)¹
- SC2 = Suspended cable 78.7" (2m)¹
- SC3 = Suspended cable 118.1" (3m)¹
- SR1 = Suspended rigid swivel stem 39.4" (1m)
- SR2 = Suspended rigid swivel stem 78.7" (2m)
- SR3 = Suspended rigid swivel stem 118.1" (3m)
- SRX = Suspended rigid swivel stem (specify to nearest 0.25", 118.1" max.)

Canopy

- 5 = 5" dia. for 4" j-box
- X = No Canopy (surface mount only)

Power²

- L = Low Power, 6.3W @ 350mA
- M = Mid Power, 9W @ 250mA
- H = High Power, 12W @ 350mA

CRI

- 92 = 92 CRI
- 98 = 98 CRI (n/a for WD)

CCT³

- 27 = 2700K
- 30 = 3000K
- 35 = 3500K
- 40 = 4000K
- WD = Warm Dimming 1800 - 3000K

Remote Driver⁴

- RS010 = Remote eldoLED 0-10V 1% dimming, 120-277V (22W, 50W or 100W)
- RD010 = Remote eldoLED 0-10V 0.1% dimming, 120-277V (22W, 50W or 100W)
- RSPH = Remote phase (2-wire) 3% dimming, 120V only (20W)
- RPEQ0 = Remote Lutron Hi-Lume Premier 0.1% EcoSystem dimming, 120-277V (20W)
- RD2S = Remote DALI-2 (DT6) for Static White 0.1% dimming, 120-277V (22W, 50W or 100W)
- X = No Driver⁵

Cover

- RRC = Round Recessed Cone

Lens (one accessory per fixture)

- OA = Open Aperture
- SOL = Solite Lens
- LSL = Linear Spread Lens
- HL = Honeycomb Louver

Beam

- 15 = 15° Beam Angle (n/a for WD)
- 20 = 20° Beam Angle
- 25 = 25° Beam Angle
- 35 = 35° Beam Angle (40° for WD)
- 50 = 50° Beam Angle

Housing / Reflector Finish⁶

- W = White, RAL 9003 (standard)
- B = Black, RAL 9017
- S = Silver, RAL 9006
- F = Custom finish, specify RAL code

Options

- EM = Emergency LED battery backup (remote only)
- WL = Wet location (IP65)
- AWNRF = Lutron Athena Wireless Node RF (RS010, RD010, RD2S drivers only)

Powered by **I B L** Whitegoods reserves the right to change any information without prior notice.

Notes

- Suspended cable field adjustable.
- Wattage shown does not include power supplies/drivers.
- See photometric data sheet for delivered lumens.
- See driver information for details.
- Refer to driver information page for driver options that can power multiple fixtures.
- Fixture, stem and canopy finish match.

index

technical
information



2.4" ProTools Downlight Round Cylinder Tall



2.4" round ceiling mounted cylinder downlight with 1.6" diameter regressed light aperture.

Luminaire	Die-cast aluminum for precision fit and heat dissipation Mounting hardware for all ceiling types; surface and suspended Round open aperture with minimal ceiling interruption and regressed optical chamber Finishes: White, Black, Silver and custom (housing and reflector)
Mounting	SM - Surface Mount SC - Suspended Cable (field adjustable) SR - Suspended Rigid swivel stem 5" dia. for mounting to 4" j-box
Cover	RRC - Round Recessed Cone for low brightness, general illumination
LED	Constant Current, 92+ CRI (standard), 98+ CRI (optional), 2-Step MacAdam Low/Mid/High output choices (delivers up to 140 lumens per watt) 2700K, 3000K, 3500K, 4000K Warm Dim (1800 - 3000K) L70 (TM21 Projected 85°C) Static White + Warm Dim = 55,000 hours
Lens	OA - Open Aperture SOL - Solite Lens LSL - Linear Spread Lens HL - Honeycomb Louver
Beam	15°, 20°, 25°, 35°, 50°
Driver	Integral and remote drivers for all dimming and non-dimming applications 0-10V, Phase, Lutron and DALI driver options POE driver compatibility
Warranty	5-year Limited (see complete company warranty information)
Certifications	ETL and ETL-C for dry and damp location, WL Wet Location (IP65) optional

Canopy (5" dia, 4" j-box)

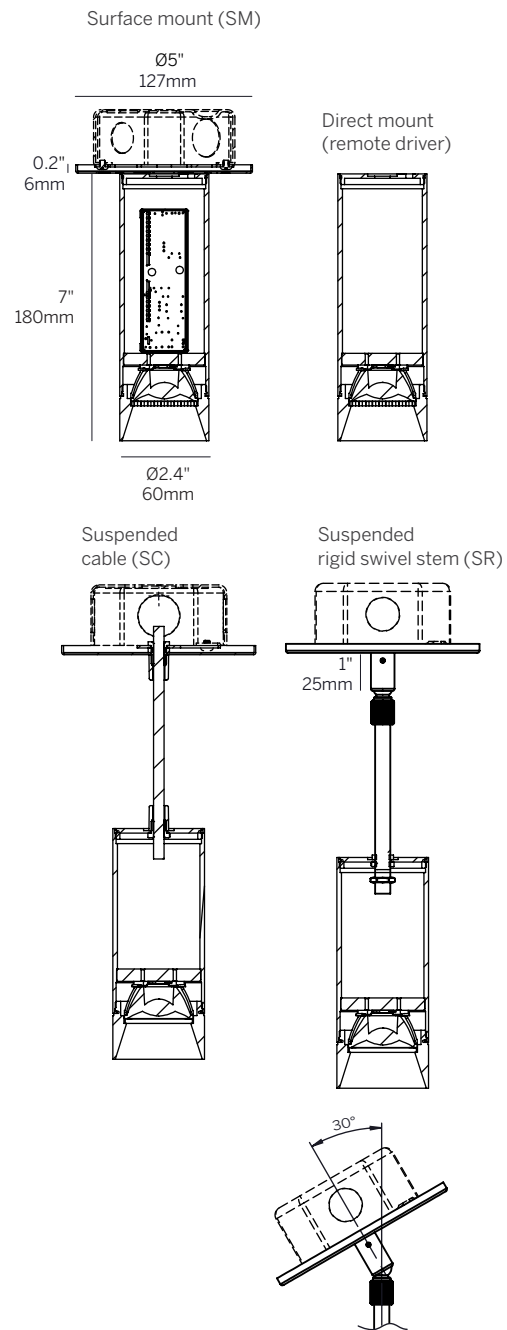
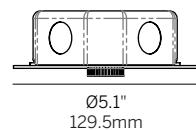

2.4" ProTools Downlight Round Cylinder Tall

Model	Mounting	Canopy	Power ²	CRI	CCT ³	Driver ⁴	Cover	Lens	Beam	Finish ⁶	Options
WG-60RPTDLID	SM SC1 ¹ SC2 ¹ SC3 ¹ SR1 SR2 SR3 SRX	5 X	L M H	92 98	27 30 35 40 WD	S010* D010* SPH* PEQO* D2S* X ⁵	RRC	OA SOL LSL HL	15 20 25 35 50	W (std) B S F	EM WL AWNRF

*Add 'R' for remote driver, ex. 'RS010'

Model

- WG-60RPTDLID = 2.4" ProTools Downlight Round Cylinder (Integral Driver)

Mounting

- SM = Surface mounted
- SC1 = Suspended cable 39.4" (1m)¹
- SC2 = Suspended cable 78.7" (2m)¹
- SC3 = Suspended cable 118.1" (3m)¹
- SR1 = Suspended rigid swivel stem 39.4" (1m)
- SR2 = Suspended rigid swivel stem 78.7" (2m)
- SR3 = Suspended rigid swivel stem 118.1" (3m)
- SRX = Suspended rigid swivel stem (specify to nearest 0.25", 118.1" max.)

Canopy

- 5 = 5" dia. for 4" j-box
- X = No Canopy (surface mount only)

Power²

- L = Low Power, 6.3W @ 350mA
- M = Mid Power, 9W @ 250mA
- H = High Power, 12W @ 350mA

CRI

- 92 = 92 CRI
- 98 = 98 CRI (n/a for WD)

CCT³

- 27 = 2700K
- 30 = 3000K
- 35 = 3500K
- 40 = 4000K
- WD = Warm Dimming 1800 - 3000K

Integral Driver⁴

- S010 = eldoLED 0-10V 1% dimming, 120-277V (22W)
- D010 = eldoLED 0-10V 0.1% dimming, 120-277V (22W)
- SPH = Phase (2-wire) 3% dimming, 120V only (20W)
- PEQO = Lutron Hi-Lume Premier 0.1% EcoSystem dimming, 120-277V (20W)
- D2S = DALI-2 (DT6) for Static White 0.1% dimming, 120-277V (22W)

Remote Driver⁴

- RS010 = Remote eldoLED 0-10V 1% dimming, 120-277V (22W, 50W or 100W)
- RD010 = Remote eldoLED 0-10V 0.1% dimming, 120-277V (22W, 50W or 100W)
- RSPH = Remote phase (2-wire) 3% dimming, 120V only (20W)
- RPEQO = Remote Lutron Hi-Lume Premier 0.1% EcoSystem dimming, 120-277V (20W)
- RD2S = Remote DALI-2 (DT6) for Static White 0.1% dimming, 120-277V (22W, 50W or 100W)
- X = No Driver⁵

Cover

- RRC = Round Recessed Cone

Lens (one accessory per fixture)

- OA = Open Aperture
- SOL = Solite Lens
- LSL = Linear Spread Lens
- HL = Honeycomb Louver

Beam

- 15 = 15° Beam Angle (n/a for WD)
- 20 = 20° Beam Angle
- 25 = 25° Beam Angle
- 35 = 35° Beam Angle (40° for WD)
- 50 = 50° Beam Angle

Housing / Reflector Finish⁶

- W = White, RAL 9003 (standard)
- B = Black, RAL 9017
- S = Silver, RAL 9006
- F = Custom finish, specify RAL code

Options

- EM = Emergency LED battery backup (remote only)
- WL = Wet location (IP65)
- AWNRF = Lutron Athena Wireless Node RF (RS010, RD010, RD2S drivers only)

Powered by **I B L** Whitegoods reserves the right to change any information without prior notice.

Notes

- Suspended cable field adjustable.
- Wattage shown does not include power supplies/drivers.
- See photometric data sheet for delivered lumens.
- See driver information for details.
- Refer to driver information page for driver options that can power multiple fixtures.
- Fixture, stem and canopy finish match.

index

technical
information



2.4" ProTools Downlight Round Cylinder Wall Mount



Surface wall mount (SW)

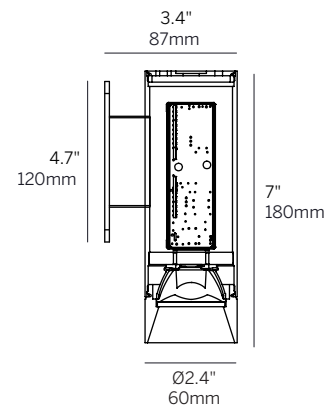

Surface wall mount (single gang J-box)

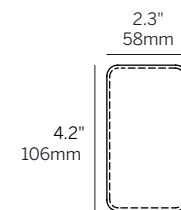

Wall mounted 2.4" round cylinder downlight with 1.6" diameter regressed light aperture.

Luminaire	Die-caste aluminum for precision fit and heat dissipation Mounting hardware for all wall types Round open aperture with regressed optical chamber Finishes: White, Black, Silver and custom (housing and reflector)
Mounting	SW - Surface Wall Mount (single gang J-box)
Cover	RRC - Round Recessed Cone for low brightness, general illumination
LED	Constant Current, 92+ CRI (standard), 98+ CRI (optional), 2-Step MacAdam Low/Mid/High output choices (delivers up to 140 lumens per watt) 2700K, 3000K, 3500K, 4000K Warm Dim (1800 - 3000K) L70 (TM21 Projected 85°C) Static White + Warm Dim = 55,000 hours
Lens	OA - Open Aperture SOL - Solite Lens LSL - Linear Spread Lens HL - Honeycomb Louver
Beam	15°, 20°, 25°, 35°, 50°
Driver	Integral and remote drivers for all dimming and non-dimming applications 0-10V, Phase, Lutron and DALI driver options POE driver compatibility
Warranty	5-year Limited (see complete company warranty information)
Certifications	ETL and ETL-C for dry and damp location

2.4" ProTools Downlight Round Cylinder Wall Mount

Model	Mounting	Power ¹	CRI	CCT ²	Driver ³	Cover	Lens	Beam	Finish ⁵	Options
WG-60RPTDL	SW	L M H	92 98	27 30 35 40 WD	S010* D010* SPH* PEQ0* D2S* X ⁴	RRC	OA SOL LSL HL	15 20 25 35 50	W (std) B S F	EM AWNRF

*Add 'R' for remote driver, ex. 'RS010'

Model

- WG-60RPTDL = 2.4" ProTools Downlight Round Cylinder Wall Mount

Mounting

- SW = Surface Wall Mount (single gang J-box)

Power¹

- L = Low Power, 6.3W @ 350mA
- M = Mid Power, 9W @ 250mA
- H = High Power, 12W @ 350mA

CRI

- 92 = 92 CRI
- 98 = 98 CRI (n/a for WD)

CCT²

- 27 = 2700K
- 30 = 3000K
- 35 = 3500K
- 40 = 4000K
- WD = Warm Dimming 1800 - 3000K

Integral Driver³

- S010 = eldoLED 0-10V 1% dimming, 120-277V (22W)
- D010 = eldoLED 0-10V 0.1% dimming, 120-277V (22W)
- SPH = Phase (2-wire) 3% dimming, 120V only (20W)
- PEQ0 = Lutron Hi-Lume Premier 0.1% EcoSystem dimming, 120-277V (20W)
- D2S = DALI-2 (DT6) for Static White 0.1% dimming, 120-277V (22W)

Remote Driver³

- RS010 = Remote eldoLED 0-10V 1% dimming, 120-277V (22W, 50W or 100W)
- RD010 = Remote eldoLED 0-10V 0.1% dimming, 120-277V (22W, 50W or 100W)
- RSPH = Remote phase (2-wire) 3% dimming, 120V only (20W)
- RPEQ0 = Remote Lutron Hi-Lume Premier 0.1% EcoSystem dimming, 120-277V (20W)
- RD2S = Remote DALI-2 (DT6) for Static White 0.1% dimming, 120-277V (22W, 50W or 100W)
- X = No Driver⁴

Cover

- RRC = Round Recessed Cone

Lens (one accessory per fixture)

- OA = Open Aperture
- SOL = Solite Lens
- LSL = Linear Spread Lens
- HL = Honeycomb Louver

Beam

- 15 = 15° Beam Angle (n/a for WD)
- 20 = 20° Beam Angle
- 25 = 25° Beam Angle
- 35 = 35° Beam Angle (40° for WD)
- 50 = 50° Beam Angle

Housing / Reflector Finish⁵

- W = White, RAL 9003 (standard)
- B = Black, RAL 9017
- S = Silver, RAL 9006
- F = Custom finish, specify RAL code

Options

- EM = Emergency LED battery backup (remote only)
- AWNRF = Lutron Athena Wireless Node RF (RS010, RD010, RD2S drivers only)

Powered by **I B L** Whitegoods reserves the right to change any information without prior notice.

Notes

- Wattage shown does not include power supplies/drivers.
- See photometric data sheet for delivered lumens.
- See driver information for details.
- Refer to driver information page for driver options that can power multiple fixtures.
- Fixture and wall plate finish match.

index

technical
information



4" ProTools Downlight Round Cylinder



4" round ceiling mounted cylinder downlight with 1.6" diameter regressed light aperture.

Luminaire	Die-caste aluminum for precision fit and heat dissipation Mounting hardware for all ceiling types; surface and suspended Round open aperture with minimal ceiling interruption and regressed optical chamber Housing Finishes: White, Black, Silver and custom Reflector Finishes: White, Black, Silver and custom
Mounting	SM - Surface Mount SC - Suspended Cable (field adjustable) SR - Suspended Rigid swivel stem 5" dia. for mounting to 4" j-box
Cover	RRC - Round Recessed Cone for low brightness, general illumination
LED	Constant Current, 92+ CRI (standard), 98+ CRI (optional), 2-Step MacAdam Low/Mid/High output choices (delivers up to 140 lumens per watt) 2700K, 3000K, 3500K, 4000K Warm Dim (1800 - 3000K) L70 (TM21 Projected 85°C) Static White + Warm Dim = 55,000 hours
Lens	OA - Open Aperture SOL - Solite Lens LSL - Linear Spread Lens HL - Honeycomb Louver
Beam	15°, 20°, 25°, 35°, 50°
Driver	Integral and remote drivers for all dimming and non-dimming applications 0-10V, Phase, Lutron and DALI driver options POE driver compatibility
Warranty	5-year Limited (see complete company warranty information)
Certifications	ETL and ETL-C for dry and damp location, WL wet location (IP65) optional

Canopy (5" dia, 4" j-box)

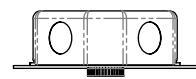

Ø5.1"
129.5mm

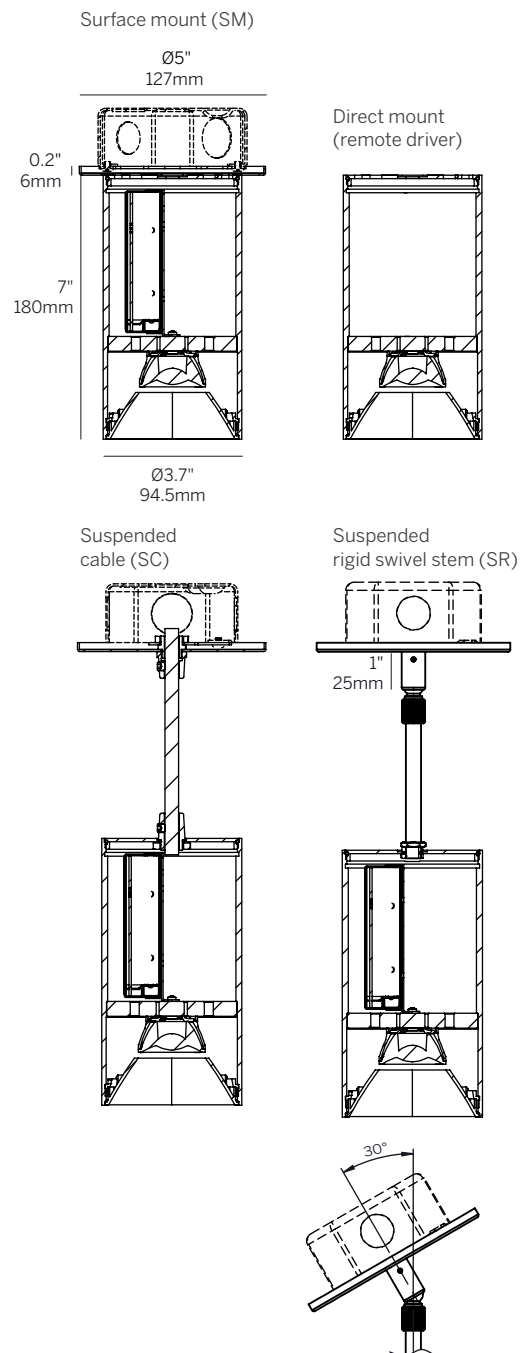

4" ProTools Downlight Round Cylinder

Model	Mounting	Canopy	Power ²	CRI	CCT ³	Driver ⁴	Cover	Lens	Beam	Housing Finish ⁶	Reflector Finish	Options
WG-100RPTDL	SM SC1 ¹ SC2 ¹ SC3 ¹ SR1 SR2 SR3 SRX	5 X	L M H	92 98	27 30 35 40 WD	S010* D010* SPH* PEQ0* D2S* X ⁵	RRC	OA SOL LSL HL	15 20 25 35 50	W (std) B S F	W (std) B S F	EM WL AWNRF

*Add 'R' for remote driver, ex. 'RS010'

Model

- WG-100RPTDL = 4" ProTools Downlight Round Cylinder

Mounting

- SM = Surface mounted
- SC1 = Suspended cable 39.4" (1m)¹
- SC2 = Suspended cable 78.7" (2m)¹
- SC3 = Suspended cable 118.1" (3m)¹
- SR1 = Suspended rigid swivel stem 39.4" (1m)
- SR2 = Suspended rigid swivel stem 78.7" (2m)
- SR3 = Suspended rigid swivel stem 118.1" (3m)
- SRX = Suspended rigid swivel stem (specify to nearest 0.25", 118.1" max.)

Canopy

- 5 = 5" dia. for 4" j-box
- X = No Canopy (surface mount only)

Power²

- L = Low Power, 6.3W @ 350mA
- M = Mid Power, 9W @ 250mA
- H = High Power, 12W @ 350mA

CRI

- 92 = 92 CRI
- 98 = 98 CRI (n/a for WD)

CCT³

- 27 = 2700K
- 30 = 3000K
- 35 = 3500K
- 40 = 4000K
- WD = Warm Dimming 1800 - 3000K

Integral Driver⁴

- S010 = eldoLED 0-10V 1% dimming, 120-277V (22W)
- D010 = eldoLED 0-10V 0.1% dimming, 120-277V (22W)
- SPH = Phase (2-wire) 3% dimming, 120V only (20W)
- PEQ0 = Lutron Hi-Lume Premier 0.1% EcoSystem dimming, 120-277V (20W)
- D2S = DALI-2 (DT6) for Static White 0.1% dimming, 120-277V (22W)

Remote Driver⁴

- RS010 = Remote eldoLED 0-10V 1% dimming, 120-277V (22W, 50W or 100W)
- RD010 = Remote eldoLED 0-10V 0.1% dimming, 120-277V (22W, 50W or 100W)
- RSPH = Remote phase (2-wire) 3% dimming, 120V only (20W)
- RPEQ0 = Remote Lutron Hi-Lume Premier 0.1% EcoSystem dimming, 120-277V (20W)
- RD2S = Remote DALI-2 (DT6) for Static White 0.1% dimming, 120-277V (22W, 50W or 100W)
- X = No Driver⁵

Cover

- RRC = Round Recessed Cone

Lens (one accessory per fixture)

- OA = Open Aperture
- SOL = Solite Lens
- LSL = Linear Spread Lens
- HL = Honeycomb Louver

Beam

- 15 = 15° Beam Angle (n/a for WD)
- 20 = 20° Beam Angle
- 25 = 25° Beam Angle
- 35 = 35° Beam Angle (40° for WD)
- 50 = 50° Beam Angle

Housing Finish⁶

- W = White, RAL 9003 (standard)
- B = Black, RAL 9017
- S = Silver, RAL 9006
- F = Custom finish, specify RAL code

Reflector Finish

- W = White, RAL 9003 (standard)
- B = Black, RAL 9017
- S = Silver, RAL 9006
- F = Custom finish, specify RAL code

Options

- EM = Emergency LED battery backup (remote only)
- WL = Wet location (IP65)
- AWNRF = Lutron Athena Wireless Node RF (RS010, RD010, RD2S drivers only)

Powered by **I B L** Whitegoods reserves the right to change any information without prior notice.

Notes

- Suspended cable field adjustable.
- Wattage shown does not include power supplies/drivers.
- See photometric data sheet for delivered lumens.
- See driver information for details.
- Refer to driver information page for driver options that can power multiple fixtures.
- Fixture, stem and canopy finish match.

index

technical
information



4" ProTools Downlight Square Dark Cylinder



4" square ceiling mounted cylinder downlight with 1.6" diameter regressed light aperture.

Luminaire	Die-caste aluminum for precision fit and heat dissipation Mounting hardware for all ceiling types; surface and suspended Square open aperture with minimal ceiling interruption and regressed optical chamber Housing Finishes: White, Black, Silver and custom Reflector Finishes: Matte White, Matte Black, Black Chrome, Silver Chrome, Champagne Gold and custom
Mounting	SM - Surface Mount SC - Suspended Cable (field adjustable) SR - Suspended Rigid swivel stem 5" dia. for mounting to 4" j-box
Cover	SRC - Square Recessed Cone for low brightness, general illumination
LED	Constant Current, 92+ CRI (standard), 98+ CRI (optional), 2-Step MacAdam Low/Mid/High output choices (delivers up to 140 lumens per watt) 2700K, 3000K, 3500K, 4000K Warm Dim (1800 - 3000K) L70 (TM21 Projected 85°C) Static White + Warm Dim = 55,000 hours
Lens	OA - Open Aperture SOL - Solite Lens LSL - Linear Spread Lens HL - Honeycomb Louver
Beam	15°, 20°, 25°, 35°, 50°
Driver	Remote drivers for all dimming and non-dimming applications 0-10V, Phase, Lutron and DALI driver options POE driver compatibility
Warranty	5-year Limited (see complete company warranty information)
Certifications	ETL and ETL-C for dry and damp location, WL Wet Location (IP65) optional

Canopy (5" dia, 4" j-box)

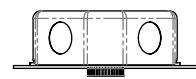

Ø5.1"
129.5mm

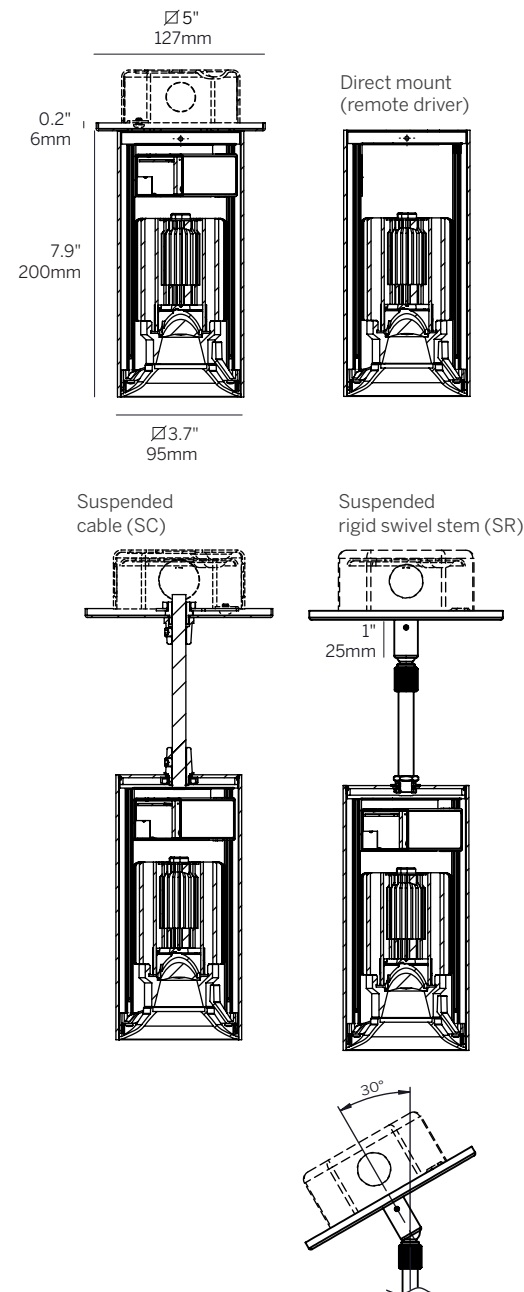

4" ProTools Downlight Square Dark Cylinder

Model	Mounting	Canopy	Power ²	CRI	CCT ³	Driver ⁴	Cover	Lens	Beam	Housing Finish ⁶	Reflector Finish	Options
WG-100SPTDL	SM SC1 ¹ SC2 ¹ SC3 ¹ SR1 SR2 SR3 SRX	5 X	L M H	92 98	27 30 35 40 WD	RS010 RD010 RSPH RPEQ0 RD2S X ⁵	SRC	OA SOL LSL HL	15 25 35 50	W (std) B S F	MW (std) MB BC SC CG F	EM WL AWNRF

Model

- WG-100SPTDL = 4" ProTools Downlight Square Cylinder

Mounting

- SM = Surface mounted
- SC1 = Suspended cable 39.4" (1m)¹
- SC2 = Suspended cable 78.7" (2m)¹
- SC3 = Suspended cable 118.1" (3m)¹
- SR1 = Suspended rigid swivel stem 39.4" (1m)
- SR2 = Suspended rigid swivel stem 78.7" (2m)
- SR3 = Suspended rigid swivel stem 118.1" (3m)
- SRX = Suspended rigid swivel stem (specify to nearest 0.25", 118.1" max.)

Canopy

- 5 = 5" dia. for 4" j-box
- X = No Canopy (surface mount only)

Power²

- L = Low Power, 6.3W @ 350mA
- M = Mid Power, 9W @ 250mA
- H = High Power, 12W @ 350mA

CRI

- 92 = 92 CRI
- 98 = 98 CRI (n/a for WD)

CCT³

- 27 = 2700K
- 30 = 3000K
- 35 = 3500K
- 40 = 4000K
- WD = Warm Dimming 1800 - 3000K

Remote Driver⁴

- RS010 = Remote eldoLED 0-10V 1% dimming, 120-277V (22W, 50W or 100W)
- RD010 = Remote eldoLED 0-10V 0.1% dimming, 120-277V (22W, 50W or 100W)
- RSPH = Remote phase (2-wire) 3% dimming, 120V only (20W)
- RPEQ0 = Remote Lutron Hi-Lume Premier 0.1% EcoSystem dimming, 120-277V (20W)
- RD2S = Remote DALI-2 (DT6) for Static White 0.1% dimming, 120-277V (22W, 50W or 100W)
- X = No Driver⁴

Powered by **I B L** Whitegoods reserves the right to change any information without prior notice.

Notes

- Suspended cable field adjustable.
- Wattage shown does not include power supplies/drivers.
- See photometric data sheet for delivered lumens.
- See driver information for details.
- Refer to driver information page for driver options that can power multiple fixtures.
- Fixture, stem and canopy finish match.

Cover

- SRC = Square Recessed Cone

Lens (one accessory per fixture)

- OA = Open Aperture
- SOL = Solite Lens
- LSL = Linear Spread Lens
- HL = Honeycomb Louver

Beam

- 15 = 15° Beam Angle (n/a for WD)
- 25 = 25° Beam Angle
- 35 = 35° Beam Angle (40° for WD)
- 50 = 50° Beam Angle

Housing Finish⁶

- W = White, RAL 9003 (standard)
- B = Black, RAL 9017
- S = Silver, RAL 9006
- F = Custom finish, specify RAL code

Reflector Finish

- MW = Matte White (standard)
- MB = Matte Black
- BC = Black Chrome
- SC = Silver Chrome
- CG = Champagne Gold
- F = Custom finish

Options

- EM = Emergency LED battery backup (remote only)
- WL = Wet Location (IP65)
- AWNRF = Lutron Athena Wireless Node RF (RS010, RD010, RD2S drivers only)

index

technical
information



4" ProTools Wall Wash Round Cylinder



4" round ceiling mounted cylinder low brightness wall washer with half moon regressed light aperture and flush kick reflector.

Luminaire	Die-caste aluminum for precision fit and heat dissipation Mounting hardware for all ceiling types; surface and suspended Round open aperture with minimal ceiling interruption and regressed optical chamber Housing Finishes: White, Black, Silver and custom Reflector Finishes: Silver Chrome with White Baffle, Silver Chrome with Black Baffle, Silver Chrome with Silver Baffle, and custom
Mounting	SM - Surface Mount SC - Suspended Cable (field adjustable) SR - Suspended Rigid swivel stem 5" dia. for mounting to 4" j-box
Cover	RWW - Round Wall Wash with room-side cutoff and wall wash distribution
LED	Constant Current, 92+ CRI (standard), 98+ CRI (optional), 2-Step MacAdam Low/Mid/High output choices (delivers up to 140 lumens per watt) 2700K, 3000K, 3500K, 4000K Warm Dim (1800 - 3000K) L70 (TM21 Projected 85°C) Static White + Warm Dim = 55,000 hours
Beam	Wall Wash
Driver	Integral and remote drivers for all dimming and non-dimming applications 0-10V, Phase, Lutron, DALI, DMX driver options POE driver compatibility
Warranty	5-year Limited (see complete company warranty information)
Certifications	ETL and ETL-C for dry and damp location

Canopy (5" dia, 4" j-box)

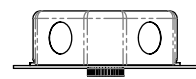

Ø5.1"
129.5mm

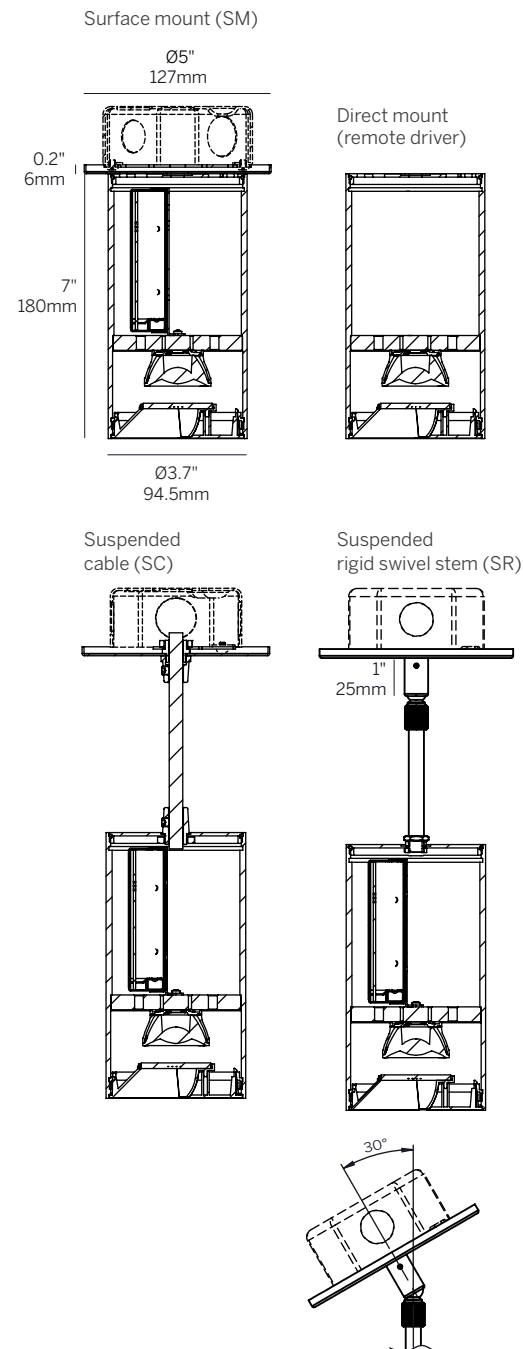

4" ProTools Wall Wash Round Cylinder

Model	Mounting	Canopy	Power ²	CRI	CCT ³	Driver ⁴	Cover	Beam	Housing Finish ⁶	Reflector Finish	Options
WG-100RPTWW	SM SC1 ¹ SC2 ¹ SC3 ¹ SR1 SR2 SR3 SRX	5 X	L M H	92 98	27 30 35 40 WD	S010 [*] D010 [*] SPH [*] PEQ0 [*] D2S [*] X ⁵	RWW	WW	W (std) B S F	SCW (std) SCB SCS SCF	EM AWNRF

*Add 'R' for remote driver, ex. 'RS010'

Model

- WG-100RPTWW = 4" ProTools Wall Wash Round Cylinder

Mounting

- SM = Surface mounted
- SC1 = Suspended cable 39.4" (1m)¹
- SC2 = Suspended cable 78.7" (2m)¹
- SC3 = Suspended cable 118.1" (3m)¹
- SR1 = Suspended rigid swivel stem 39.4" (1m)
- SR2 = Suspended rigid swivel stem 78.7" (2m)
- SR3 = Suspended rigid swivel stem 118.1" (3m)
- SRX = Suspended rigid swivel stem (specify to nearest 0.25", 118.1" max.)

Canopy

- 5 = 5" dia. for 4" j-box
- X = No Canopy (surface mount only)

Power²

- L = Low Power, 6.3W @ 350mA
- M = Mid Power, 9W @ 250mA
- H = High Power, 12W @ 350mA

CRI

- 92 = 92 CRI
- 95 = 95 CRI (n/a for WD)

CCT³

- 27 = 2700K
- 30 = 3000K
- 35 = 3500K
- 40 = 4000K
- WD = Warm Dimming 1800 - 3000K

Integral Driver⁴

- S010 = eldoLED 0-10V 1% dimming, 120-277V (22W)
- D010 = eldoLED 0-10V 0.1% dimming, 120-277V (22W)
- SPH = Phase (2-wire) 3% dimming, 120V only (20W)
- PEQ0 = Lutron Hi-Lume Premier 0.1% EcoSystem dimming, 120-277V (20W)
- D2S = DALI-2 (DT6) for Static White 0.1% dimming, 120-277V (22W)

Remote Driver⁴

- RS010 = Remote eldoLED 0-10V 1% dimming, 120-277V (22W, 50W or 100W)
- RD010 = Remote eldoLED 0-10V 0.1% dimming, 120-277V (22W, 50W or 100W)
- RSPH = Remote phase (2-wire) 3% dimming, 120V only (20W)
- RPEQ0 = Remote Lutron Hi-Lume Premier 0.1% EcoSystem dimming, 120-277V (20W)
- RD2S = Remote DALI-2 (DT6) for Static White 0.1% dimming, 120-277V (22W, 50W or 100W)
- X = No Driver⁵

Cover

- RWW = Round Wall Wash

Beam

- WW = Wall Wash

Housing Finish⁶

- W = White, RAL 9003 (standard)
- B = Black, RAL 9017
- S = Silver, RAL 9006
- F = Custom finish, specify RAL code

Reflector Finish

- SCW = Silver Chrome with White Baffle, RAL 9003 (standard)
- SCB = Silver Chrome with Black Baffle, RAL 9017
- SCS = Silver Chrome with Silver Baffle, RAL 9006
- SCF = Silver Chrome with Custom finish baffle, specify RAL

Options

- EM = Emergency LED battery backup (remote only)
- AWNRF = Lutron Athena Wireless Node RF (RS010, RD010, RD2S drivers only)

Powered by **I B L** Whitegoods reserves the right to change any information without prior notice.

Notes

- Suspended cable field adjustable.
- Wattage shown does not include power supplies/drivers.
- See photometric data sheet for delivered lumens.
- See driver information for details.
- Refer to driver information page for driver options that can power multiple fixtures.
- Fixture, stem and canopy finish match.

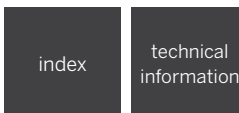

4" ProTools Wall Wash Square Cylinder



4" square ceiling mounted cylinder low brightness wall washer with rectangular regressed light aperture and flush kick reflector.

Luminaire	Die-caste aluminum for precision fit and heat dissipation Mounting hardware for all ceiling types; surface and suspended Square open aperture with minimal ceiling interruption and regressed optical chamber Housing Finishes: White, Black, Silver and custom Reflector Finishes: Silver Chrome with White Baffle, Silver Chrome with Black Baffle, Silver Chrome with Silver Baffle, and custom
Mounting	SM - Surface Mount SC - Suspended Cable (field adjustable) SR - Suspended Rigid swivel stem 5" dia. for mounting to 4" j-box
Cover	SWW - Square Wall Wash with room-side cutoff and wall wash distribution
LED	Constant Current, 92+ CRI (standard), 98+ CRI (optional), 2-Step MacAdam Low/Mid/High output choices (delivers up to 140 lumens per watt) 2700K, 3000K, 3500K, 4000K Warm Dim (1800 - 3000K) L70 (TM21 Projected 85°C) Static White + Warm Dim = 55,000 hours
Beam	WW - Wall Wash
Driver	Remote drivers for all dimming and non-dimming applications 0-10V, Phase, Lutron, DALI, DMX driver options POE driver compatibility
Warranty	5-year Limited (see complete company warranty information)
Certifications	ETL and ETL-C for dry and damp location

Canopy (5" dia, 4" j-box)

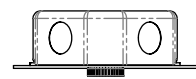

Ø5.1"
129.5mm



Surface mount (SM)

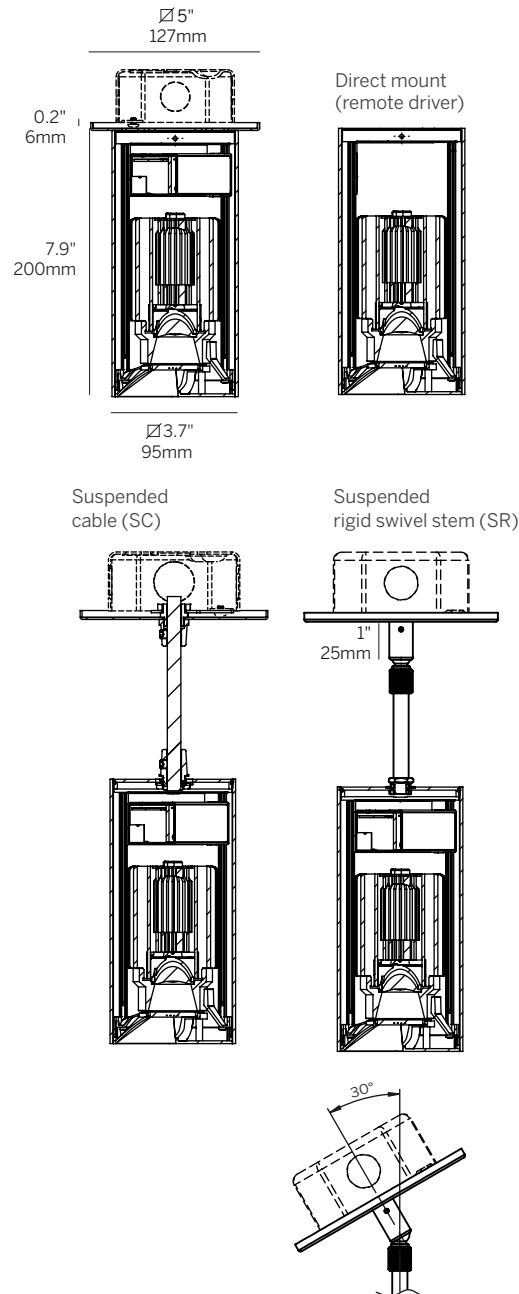

4" ProTools Wall Wash Square Cylinder

Model	Mounting	Canopy	Power ²	CRI	CCT ³	Driver ⁴	Cover	Beam	Housing Finish ⁶	Reflector Finish	Options
WG-100SPTWW	SM SC1 ¹ SC2 ¹ SC3 ¹ SR1 SR2 SR3 SRX	5 X	L M H	92 98	27 30 35 40 WD	RS010 RD010 RSPH RPEQ0 RD2S X	SWW	WW	W (std) B S F	SCW (std) SCB SCS SCF	EM AWNRF

Model

- WG-100SPTWW = 4" ProTools Wall Wash Square Cylinder

Mounting

- SM = Surface mounted
- SC1 = Suspended cable 39.4" (1m)¹
- SC2 = Suspended cable 78.7" (2m)¹
- SC3 = Suspended cable 118.1" (3m)¹
- SR1 = Suspended rigid swivel stem 39.4" (1m)
- SR2 = Suspended rigid swivel stem 78.7" (2m)
- SR3 = Suspended rigid swivel stem 118.1" (3m)
- SRX = Suspended rigid swivel stem (specify to nearest 0.25", 118.1" max.)

Canopy

- 5 = 5" dia. for 4" j-box
- X = No Canopy (surface mount only)

Power²

- L = Low Power, 6.3W @ 350mA
- M = Mid Power, 9W @ 250mA
- H = High Power, 12W @ 350mA

CRI

- 92 = 92 CRI
- 98 = 98 CRI (n/a for WD)

CCT³

- 27 = 2700K
- 30 = 3000K
- 35 = 3500K
- 40 = 4000K
- WD = Warm Dimming 1800 - 3000K

Remote Driver⁴

- RS010 = Remote eldoLED 0-10V 1% dimming, 120-277V (22W, 50W or 100W)
- RD010 = Remote eldoLED 0-10V 0.1% dimming, 120-277V (22W, 50W or 100W)
- RSPH = Remote phase (2-wire) 3% dimming, 120V only (20W)
- RPEQ0 = Remote Lutron Hi-Lume Premier 0.1% EcoSystem dimming, 120-277V (20W)
- RD2S = Remote DALI-2 (DT6) for Static White 0.1% dimming, 120-277V (22W, 50W or 100W)
- X = No Driver⁵

Cover

- SWW = Square Wall Wash

Beam

- WW = Wall Wash

Housing Finish⁶

- W = White, RAL 9003 (standard)
- B = Black, RAL 9017
- S = Silver, RAL 9006
- F = Custom finish, specify RAL code

Reflector Finish

- SCW = Silver Chrome with White Baffle, RAL 9003 (standard)
- SCB = Silver Chrome with Black Baffle, RAL 9017
- SCS = Silver Chrome with Silver Baffle, RAL 9006
- SCF = Silver Chrome with Custom finish baffle, specify RAL

Options

- EM = Emergency LED battery backup (remote only)
- AWNRF = Lutron Athena Wireless Node RF (RS010, RD010, RD2S drivers only)

Powered by **I B L** Whitegoods reserves the right to change any information without prior notice.

Notes

- Suspended cable field adjustable.
- Wattage shown does not include power supplies/drivers.
- See photometric data sheet for delivered lumens.
- See driver information for details.
- Refer to driver information page for driver options that can power multiple fixtures.
- Fixture, stem and canopy finish match.

index

technical
information



4" ProTools Downlight Round Cylinder Wall Mount



Wall mounted 4" round cylinder downlight with 1.6" diameter regressed light aperture.

Luminaire	Die-caste aluminum for precision fit and heat dissipation Mounting hardware for all wall types Round open aperture with regressed optical chamber Housing Finishes: White, Black, Silver and custom Reflector Finishes: White, Black, Silver and custom
Mounting	SW - Surface Wall Mount (single gang J-box)
Cover	RRC - Round Recessed Cone for low brightness, general illumination
LED	Constant Current, 92+ CRI (standard), 98+ CRI (optional), 2-Step MacAdam Low/Mid/High output choices (delivers up to 140 lumens per watt) 2700K, 3000K, 3500K, 4000K Warm Dim (1800 - 3000K) L70 (TM21 Projected 85°C) Static White + Warm Dim = 55,000 hours
Lens	OA - Open Aperture SOL - Solite Lens LSL - Linear Spread Lens HL - Honeycomb Louver
Beam	15°, 20°, 25°, 35°, 50°
Driver	Integral and remote drivers for all dimming and non-dimming applications 0-10V, Phase, Lutron and DALI driver options POE driver compatibility
Warranty	5-year Limited (see complete company warranty information)
Certifications	ETL and ETL-C for dry and damp location



Surface wall mount (SW)

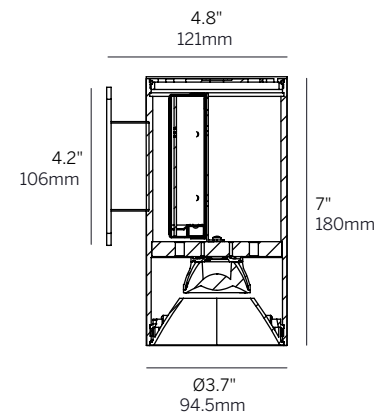

Surface wall mount (single gang J-box)

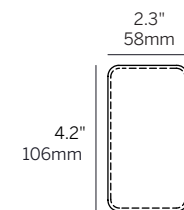

4" ProTools Downlight Round Cylinder Wall Mount

Model	Mounting	Power ¹	CRI	CCT ²	Driver ³	Cover	Lens	Beam	Housing Finish ⁶	Reflector Finish	Options
WG-100RPTDL	SW	L M H	92 98	27 30 35 40 WD	S010* D010* SPH* PEQ0* D2S* X ⁵	RRC	OA SOL LSL HL	15 20 25 35 50	W (std) B S F	W (std) B S F	EM AWNRF

*Add 'R' for remote driver, ex. 'RS010'

Model

- WG-100RPTDL = 4" ProTools Downlight Round Cylinder Wall Mount

Mounting

- SW = Surface Wall Mount (single gang J-box)

Power¹

- L = Low Power, 6.3W @ 350mA
- M = Mid Power, 9W @ 250mA
- H = High Power, 12W @ 350mA

CRI

- 92 = 92 CRI
- 98 = 98 CRI (n/a for WD)

CCT²

- 27 = 2700K
- 30 = 3000K
- 35 = 3500K
- 40 = 4000K
- WD = Warm Dimming 1800 - 3000K

Integral Driver⁴

- S010 = eldoLED 0-10V 1% dimming, 120-277V (22W)
- D010 = eldoLED 0-10V 0.1% dimming, 120-277V (22W)
- SPH = Phase (2-wire) 3% dimming, 120V only (20W)
- PEQ0 = Lutron Hi-Lume Premier 0.1% EcoSystem dimming, 120-277V (20W)
- D2S = DALI-2 (DT6) for Static White 0.1% dimming, 120-277V (22W)

Remote Driver⁴

- RS010 = Remote eldoLED 0-10V 1% dimming, 120-277V (22W, 50W or 100W)
- RD010 = Remote eldoLED 0-10V 0.1% dimming, 120-277V (22W, 50W or 100W)
- RSPH = Remote phase (2-wire) 3% dimming, 120V only (20W)
- RPEQ0 = Remote Lutron Hi-Lume Premier 0.1% EcoSystem dimming, 120-277V (20W)
- RD2S = Remote DALI-2 (DT6) for Static White 0.1% dimming, 120-277V (22W, 50W or 100W)
- X = No Driver⁵

Cover

- RRC = Round Recessed Cone

Lens (one accessory per fixture)

- OA = Open Aperture
- SOL = Solite Lens
- LSL = Linear Spread Lens
- HL = Honeycomb Louver

Beam

- 15 = 15° Beam Angle (n/a for WD)
- 20 = 20° Beam Angle
- 25 = 25° Beam Angle
- 35 = 35° Beam Angle (40° for WD)
- 50 = 50° Beam Angle

Housing Finish⁶

- W = White, RAL 9003 (standard)
- B = Black, RAL 9017
- S = Silver, RAL 9006
- F = Custom finish, specify RAL code

Reflector Finish

- W = White, RAL 9003 (standard)
- B = Black, RAL 9017
- S = Silver, RAL 9006
- F = Custom finish, specify RAL code

Options

- EM = Emergency LED battery backup (remote only)
- AWNRF = Lutron Athena Wireless Node RF (RS010, RD010, RD2S drivers only)

Powered by **I B L** Whitegoods reserves the right to change any information without prior notice.

Notes

- Wattage shown does not include power supplies/drivers.
- See photometric data sheet for delivered lumens.
- See driver information for details.
- Refer to driver information page for driver options that can power multiple fixtures.
- Fixture, stem and canopy finish match.

index

technical
information



5.5" ProTools Downlight Round Cylinder



Surface mount (SM)

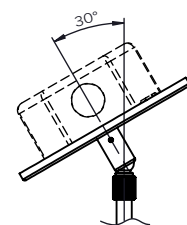
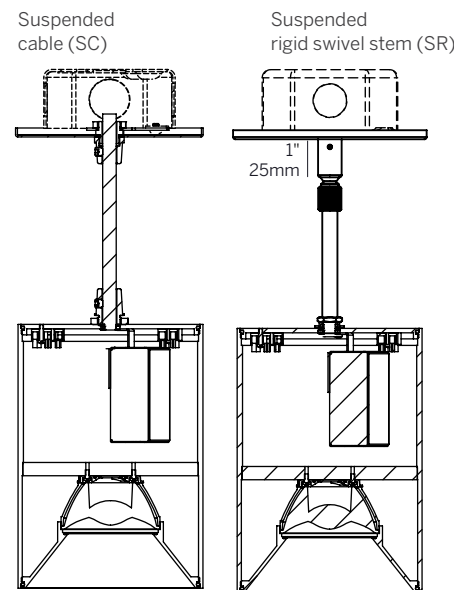
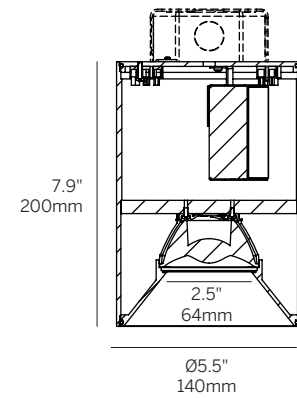

5.5" round ceiling mounted cylinder downlight with 2.5" diameter regressed light aperture.

Luminaire	Die-caste aluminum for precision fit and heat dissipation Mounting hardware for all ceiling types; surface and suspended EZ clip mounting for secure installation Round open aperture with minimal ceiling interruption and regressed optical chamber Housing / Reflector Finishes: White, Black, Silver and custom
Mounting	SM - Surface Mount SC - Suspended Cable (field adjustable) SR - Suspended Rigid swivel stem 5" dia. for mounting to 4" j-box
Cover	RRC - Round Recessed Cone for low brightness, general illumination
LED	Constant Current, 92+ CRI (standard), 98+ CRI (optional), 2-Step MacAdam High / Extra High / Super High choices (delivers up to 150 lumens per watt) 2700K, 3000K, 3500K, 4000K Warm Dim (1800 - 3000K) L70 (TM21 Projected 85°C) Static White = 66,000 hours Warm Dim = 55,000 hours
Lens	OA - Open Aperture SOL - Solite Lens LSL - Linear Spread Lens HL - Honeycomb Louver
Beam	20°, 25°, 35°, 50°, 60°
Driver	Integral and remote drivers for all dimming and non-dimming applications 0-10V, Phase, Lutron and DALI driver options POE driver compatibility
Warranty	5-year Limited (see complete company warranty information)
Certifications	ETL and ETL-C for dry and damp location, WL Wet Location (IP65) optional

Canopy (5" dia, 4" j-box)

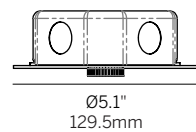

5.5" ProTools Downlight Round Cylinder

Model	Mounting	Canopy	Power ²	CRI	CCT ³	Driver ⁴	Cover	Lens	Beam	Housing Finish ⁶	Reflector Finish	Options
WG-140RPTDL	SM	5	H	92	27	S010	RRC	OA	20	W (std)	W (std)	EM
	SC1 ¹	X	XH	98	30	D010		SOL	25	B	B	WL
	SC2 ¹		SH		35	SPH		LSL	35	S	S	AWNRF
	SC3 ¹				40	PEQ0		HL	50	F	F	
	SR1				WD	D2S			60			
	SR2					RS010						
	SR3					RD010						
SRX					RD2S							
						X ⁵						

Model

- WG-140RPTDL = 5.5" ProTools Downlight Round Cylinder

Mounting

- SM = Surface Mounted
- SC1 = Suspended cable 39.4" (1m)¹
- SC2 = Suspended cable 78.7" (2m)¹
- SC3 = Suspended cable 118.1" (3m)¹
- SR1 = Suspended rigid swivel stem 39.4" (1m)
- SR2 = Suspended rigid swivel stem 78.7" (2m)
- SR3 = Suspended rigid swivel stem 118.1" (3m)
- SRX = Suspended rigid swivel stem (specify to nearest 0.25", 118.1" max.)

Canopy

- 5 = 5" dia. for 4" j-box
- X = No Canopy (surface mount only)

Power²

- H = High Power, 12W @ 350mA (n/a for WD)
- XH = Extra High, 19W @ 550mA
- SH = Super High, 26W @ 700 mA

CRI

- 92 = 92 CRI
- 98 = 98 CRI (n/a for WD)

CCT³

- 27 = 2700K
- 30 = 3000K
- 35 = 3500K
- 40 = 4000K
- WD = Warm Dimming 1800 - 3000K

Integral Driver⁴

- S010 = Standard 0-10V 1% dimming, 120-277V (30W)
- D010 = eidoLED 0-10V 0.1% dimming, 120-277V (22W) [n/a for Super High power]
- SPH = Standard Phase 1% dimming, 120V only (30W)
- PEQ0 = Lutron Hi-Lume Premier 0.1% EcoSystem dimming, 120-277V (20W) [High power only]
- D2S = DALI-2 (DT6) for Static White 0.1% dimming, 120-277V (22W) [n/a for Super High power]

Remote Driver⁴

- RS010 = Remote eidoLED 0-10V 1% dimming, 120-277V (50W or 100W)
- RD010 = Remote eidoLED 0-10V 0.1% dimming, 120-277V (50W or 100W)
- RD2S = Remote DALI-2 (DT6) for Static White 0.1% dimming, 120-277V (50W or 100W)
- X = No Driver⁵

Cover

- RRC = Round Recessed Cone

Lens (one accessory per fixture)

- OA = Open Aperture
- SOL = Solite Lens
- LSL = Linear Spread Lens
- HL = Honeycomb Louver

Beam

- 20 = 20° Beam Angle
- 25 = 25° Beam Angle
- 35 = 35° Beam Angle
- 50 = 50° Beam Angle (55° for WD)
- 60 = 60° Beam Angle (n/a for WD)

Housing Finish⁶

- W = White, RAL 9003 (standard)
- B = Black, RAL 9017
- S = Silver, RAL 9006
- F = Custom finish, specify RAL code

Reflector Finish

- W = White, RAL 9003 (standard)
- B = Black, RAL 9017
- S = Silver, RAL 9006
- F = Custom finish, specify RAL code

Options

- EM = Emergency LED battery backup (remote only)
- WL = Wet location (IP65)
- AWNRF = Lutron Athena Wireless Node RF (RS010, RD010, RD2S drivers only)

Powered by **I B L** Whitegoods reserves the right to change any information without prior notice.

Notes

- Suspended cable field adjustable.
- Wattage shown does not include power supplies/drivers.
- See photometric data sheet for delivered lumens.
- See driver information for details.
- Refer to driver information page for driver options that can power multiple fixtures. Ordered separately.
- Fixture, stem and canopy finish match.

index

technical
information



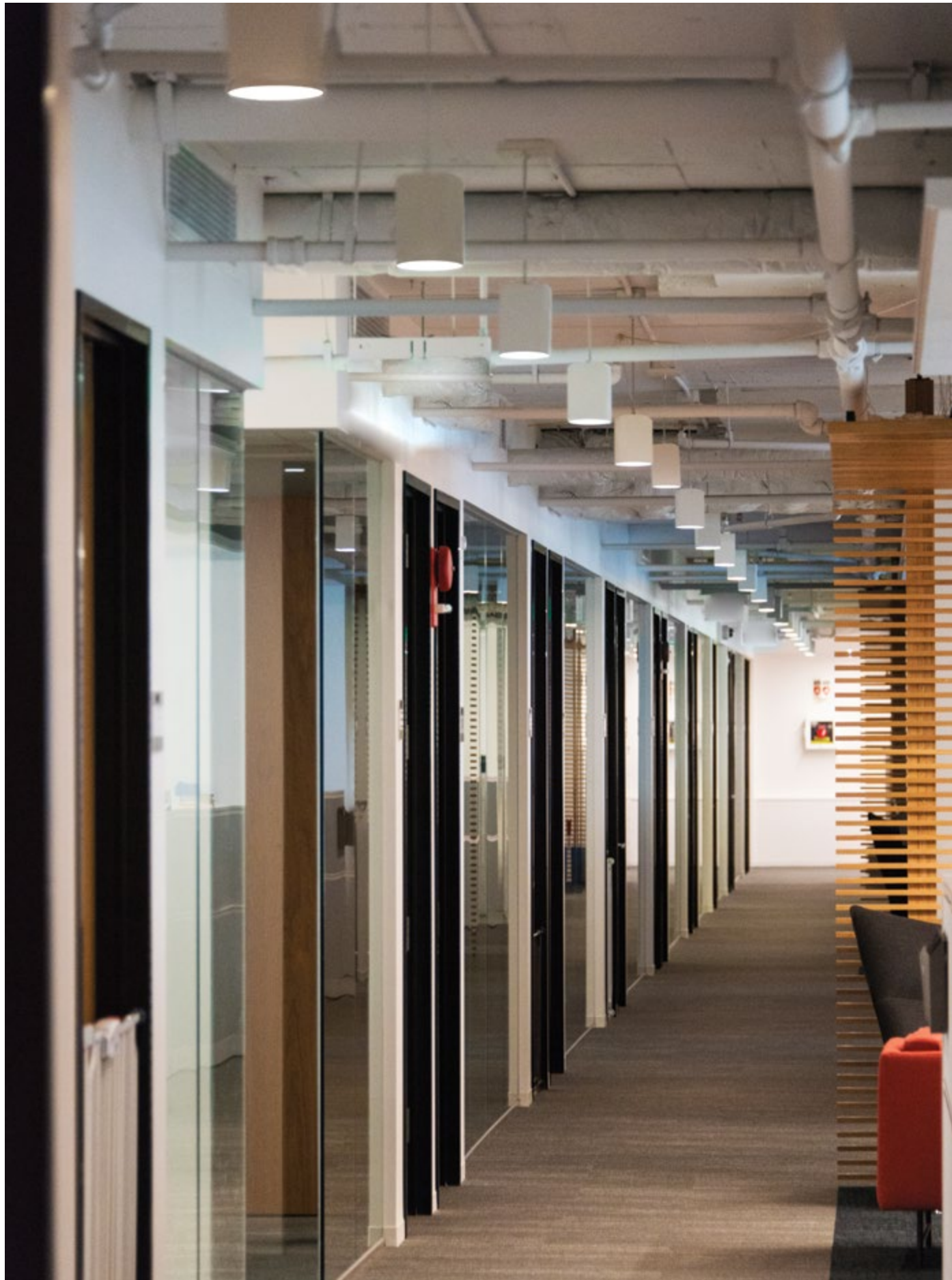

Square Ceiling / Floor Wash

Square Ceiling / Floor Wash are compact, versatile luminaires equally suited to washing light onto a floor, or when inverted, onto the ceiling. Bezel or Plaster Trim in 2.4" and 4" ceiling or floor washers for drywall.

- Ceiling Wash
- Floor Wash

Application guide
Product details

28-31
152-155



2.4" Square Ceiling / Floor Wash



2.4" square aperture recessed wall fixture with concealed source providing asymmetric illumination for ceiling or floor wash applications.

Housing	Die-caste aluminum for precision fit and heat dissipation 3/8" bezel trim compatible with installation into walls Luminaire installed and maintained from the wall side. Maximum wall thickness 5/8" (3.5" minimum clearance in wall). Spring clip mounting mechanism EZ-Click LED module installation
LED	Constant Current, 92+ CRI (standard), 2-Step MacAdam Low output (delivers up to 25 lumens per watt) 2700K, 3000K, 3500K, 4000K L70 (TM21 Projected 85°C) Static White = 66,500 hours
Optics	High angle asymmetrical distribution
Driver	Remote drivers for all dimming and non-dimming applications 0-10V, Phase, Lutron, and DALI driver options
Warranty	5-year Limited (see complete company warranty information)
Certifications	ETL and ETL-C for dry and damp location, CE

cut-out dimensions 2 3/4" x 2 3/4"



Recessed Plaster Trim



Recessed Bezel Trim

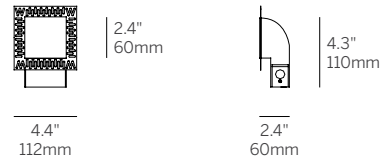

Recessed Plaster Trim (RPT)

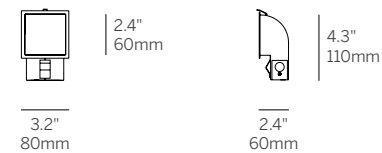

Recessed Bezel Trim (RBT)

2.4" Square Ceiling / Floor Wash

Model	Fixation	Power ¹	CRI	CCT ²	Driver ³	Finish	Options
WG-60SCFW	RPT RBT	L	92	27 30 35 40	RS010 RD010 RSPH RPEQ0 RD2S X	W	EM AWNRF

Model

- WG-60SCFW = 2.4" Square Ceiling / Floor Wash

Fixation

- RPT = Recessed plaster trim
- RBT = Recessed bezel trim

Power¹

- L = Low Power, 5.6W @ 350mA

CRI

- 92 = 92 CRI

CCT²

- 27 = 2700K
- 30 = 3000K
- 35 = 3500K
- 40 = 4000K

Driver (Remote)³

- RS010 = Remote eldoLED 0-10V 1% dimming, 120-277V (22W, 50W, 100W)
- RD010 = Remote eldoLED 0-10V 0.1% dimming, 120-277V (22W, 50W or 100W)
- RSPH = Remote phase (2-wire) 3% dimming, 120V only (20W)
- RPEQ0 = Remote Lutron Hi-Lume Premier 0.1% EcoSystem dimming, 120-277V (20W)
- RD2S = Remote DALI-2 for Static White 0.1% dimming, 120-277V (22W, 50W or 100W)
- X = No Driver

Finish

- W = White, 15% gloss, RAL 9003

Options

- EM = Emergency (remote)
- AWNRF = Lutron Athena Wireless Node RF (RS010, RD010, RD2S drivers only)

Whitegoods reserves the right to change any information without prior notice.

Notes

- 1 Wattage shown does not include power supplies/drivers.
- 2 See photometric data sheet for delivered lumens.
- 3 Refer to power supply page for details.

index

technical
information



4" Square Ceiling / Floor Wash



4" square aperture recessed wall fixture with concealed source providing asymmetric illumination for ceiling or floor wash applications.

Housing	Die-caste aluminum for precision fit and heat dissipation 3/8" bezel trim compatible with installation into walls Luminaire installed and maintained from the wall side. Maximum wall thickness 5/8" (4.5" minimum clearance in wall). Spring clip mounting mechanism EZ-Click LED module installation
LED	Constant Current, 92+ CRI (standard), 2-Step MacAdam Low/Mid/High output choices (delivers up to 63 lumens per watt) 2700K, 3000K, 3500K, 4000K L70 (TM21 Projected 85°C) Static White = 55,400 hours
Optics	High angle asymmetrical distribution
Driver	Remote drivers for all dimming and non-dimming applications 0-10V, Phase, Lutron, and DALI driver options
Warranty	5-year Limited (see complete company warranty information)
Certifications	ETL and ETL-C for dry and damp location, CE

cut-out dimensions 4 5/8" x 4 5/8"



Recessed Plaster Trim



Recessed Bezel Trim

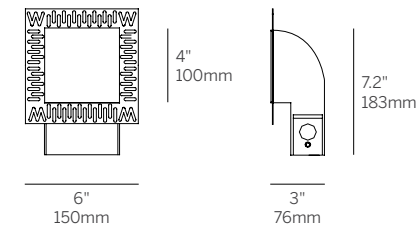

Recessed Plaster Trim (RPT)

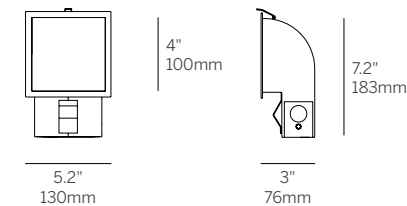

Recessed Bezel Trim (RBT)

4" Square Ceiling / Floor Wash

Model	Fixation	Power ¹	CRI	CCT ²	Driver ³	Finish	Options
WG-100SCFW	RPT RBT	L M H	92	27 30 35 40	RS010 RD010 RSPH RPEQ0 RD2S X	W	EM AWNRF

Model

- WG-100SCFW = 4" Square Ceiling / Floor Wash

Fixation

- RPT = Recessed plaster trim
- RBT = Recessed bezel trim

Power¹

- L = Low power, 8.1W @ 250mA
- M = Mid power, 11.5W @ 350mA
- H = High power, 16.8W @ 500mA

CRI

- 92 = 92 CRI

CCT²

- 27 = 2700K
- 30 = 3000K
- 35 = 3500K
- 40 = 4000K

Driver (Remote)³

- RS010 = Remote eldoLED 0-10V 1% dimming, 120-277V (22W, 50W, 100W)
- RD010 = Remote eldoLED 0-10V 0.1% dimming, 120-277V (22W, 50W or 100W)
- RSPH = Remote phase (2-wire) 3% dimming, 120V only (20W)
- RPEQ0 = Remote Lutron Hi-Lume Premier 0.1% EcoSystem dimming, 120-277V (20W)
- RD2S = Remote DALI-2 for Static White 0.1% dimming, 120-277V (22W, 50W or 100W)
- X = No Driver

Finish

- W = White, 15% gloss, RAL 9003

Options

- EM = Emergency (remote)
- AWNRF = Lutron Athena Wireless Node RF (RS010, RD010, RD2S drivers only)

Whitegoods reserves the right to change any information without prior notice.

Notes

- 1 Wattage shown does not include power supplies/drivers.
- 2 See photometric data sheet for delivered lumens.
- 3 Refer to power supply page for details.

index

technical
information



The application of light to the surfaces around us is a critical factor in our perception of any space.

When proper consideration is given to the architecture, function and the desired atmosphere, lighting can become a truly integrated part of the overall environment being created, often unseen although defining and enhancing the space.